

Powerpole® & Multipole Connectors | 10A up to 550A

- *Battery Charging* • *Material Handling* • *E-Mobility*
- *Telecommunications* • *Industrial* • *Commercial Applications*



APP
Anderson Power Products®

An **IDEAL** Company

Global Presence

Anderson Power Products® (APP®) Has a Global Distribution Network in the following countries along with many others: Argentina, Australia, Belgium, Brazil, Canada, Chile, China, Columbia, Denmark, France, Germany, Greece, Hong Kong, Ireland, Israel, Italy, Japan, Mexico, New Zealand, Norway, Peru, Poland, Portugal, Singapore, Slovenia, South Africa, South Korea, Spain, Switzerland, Thailand, Turkey, United Kingdom, India and United States.



Our philosophy is to provide products and services within the trading markets of our customers. We currently serve our worldwide customer base from customer support; and manufacturing distribution facilities in Sterling, MA, U.S.A., Warrington UK for European customers, as well as three Asia Pacific facilities: Shenzhen, China, Shatin Hong Kong, Taichung City 407, Taiwan (R.O.C.), and Haryana, India.

Today, as a result of innovative design and development, we have evolved into a valued supplier for a wide variety of markets including Material Handling / Datacom / Telecom / Wireless / E-mobility / Commercial / Consumer / Battery Charging and more.

We have established a reputation for high quality products, on-time deliveries, and excellent customer service. As a result of modern manufacturing techniques and rigorous quality control measures, this assures our customers receive the quality products they deserve.

As a global company dedicated to best environmental practice, we have taken steps to meet the RoHS directive for virtually all products. We look forward to the challenges posed by the new technologies of the future and will continue our century long tradition of design excellence and superior customer support to meet customers' needs.

© 2020 Anderson Power Products, Inc. All rights reserved. This catalog or it's content may be downloaded only for your personal, non-commercial use.

Anderson™ will use reasonable efforts to include accurate and up-to-date content in the catalog. All product information contained in the catalog including ordering information, illustrations, specifications, and dimensions, are believed to be reliable as of the date of publishing, but is subject to change without notice. Anderson™ makes no warranty or representation as to its accuracy. Content in the catalog may contain technical inaccuracies, typographical errors and may be changed or updated without notice. Anderson™ may also make improvements and/or changes to the products and/or to the programs described in the content at any time without notice. Current sales drawings and specifications are available upon request or can be downloaded from Technical Section found under Product Pages <https://www.andersonpower.com/us/en/ProductPages.html>

Neither Anderson™ nor any party involved in creating, producing, or delivering this catalog shall be liable for any direct, incidental, consequential, indirect, or punitive damages arising out of your use of this catalog or any errors or omissions in its content.

All product names, including, but not limited to A®, A in circle, Anderson Power Products®, APP®, Powerpole®, SB®, SBE®, SBO®, SBS®, SBX®, SPEC Pak®, Saf-D-Grid®, Power Clip®, Power Drawer®, PowerMod® and the APP Logo are registered trademarks of Anderson Power Products, Inc. Anderson™ and Your Best Connection™ are trademarks of Anderson Power Products, Inc.

Powerpole® & Multipole Catalog

Section 1

| | |
|----------------------------------|----|
| Product Selector | 2 |
| Tooling | 4 |
| Technical Reference | 11 |
| Engineering Reference | 16 |
| Frequently Asked Questions | 19 |
| Glossary | 23 |

Section 2

| | |
|------------------------|----|
| Powerpole® | 26 |
| PP15/45 | 30 |
| Powerpole® Pak | 33 |
| Powerpole® PP75 | 41 |
| Powerpole® PP120 | 48 |
| Powerpole® PP180 | 52 |

Section 3

| | |
|--|-----|
| Multipole | 58 |
| SBS® Mini | 63 |
| SBS® 50 & 75 | 67 |
| SB® 50 | 78 |
| SB® 120 | 84 |
| SB® 175 | 88 |
| SB® 350 | 96 |
| SBE® 80 / SBO® 60 | 102 |
| SBE® 160 / SBX® 175 | 108 |
| SBE® 320 / SBX® 350 | 115 |
| - PPMX Auxiliary Holder for SBO®, SBE® & SBX® | 106 |
| | 112 |
| | 120 |
| SB® SMART | 124 |

Section 4

| | |
|----------------------------------|-----|
| Part Number Page Reference | 129 |
|----------------------------------|-----|

Product Selector Guide

How to Use This Catalog

The information in this catalog is provided in layers to allow you to quickly find the information you are looking for.

1. Selection Guides are featured at the front of the catalog and at the beginning of each product section to enable quick connector selection by electrical attributes and other features.
2. A Technical Reference is provided to give important information common to all connectors in this catalog. Answers to common questions, definitions of terminology, and technical charts are all included.
3. Overviews at the beginning of each product main section describe the similarities and call out common features of products within that section.
4. Specifications and Temperature Charts are shown after the main connector components in each sub-product section to provide detailed technical information (SB® 50, SB® 120, etc).
5. Tooling Charts are provided at the end of each connector family (SB®, SBS® etc) to quickly identify the correct tooling.

| | Powerpole® Connector Family | Multipole Connector Family |
|---------------------------|-----------------------------|----------------------------|
| Page Number | 26 | 58 |
| Amps (UL) Per Pole | Up to 350 | Up to 550 |
| Volts (UL) Per Pole | Up to 600 | Up to 600 |
| Wire Gauge - AWG (mm²) | 20 to 30 (0.75 to 85.0) | 16 to 350 mcm (1.3 to 185) |
| Number of Power Circuits | 1 / Stackable | 2 to 3 / Not Stackable |
| Ground | • | • |
| Auxiliary | | • |
| PCB Mount | • | • |
| Busbar | • | • |
| Panel Mount | • | • |
| Blindmate | • | |
| Hot Plug | • | • |
| Touch Safe | • | • |
| Strain Relief | • | • |
| Polarized Housing | • | • |
| Mechanical Keyed | | • |
| Latching | • | |
| Handle | | • |
| Air Supply System | | • |
| Dust / Ingress Protection | • | • |

Custom Connector Capabilities

We specialize in the design and manufacture of high current connection systems to meet specific customer needs. Our expertise in high amperage connections, multiple types of contact technology, and molded plastic insulators allow us to provide durable, high power connections that fulfill the project requirements of OEM's.

We look forward to working with OEM's on their manufacturing scale projects to provide connector solutions which our current product portfolio may not satisfy. Marketing, Engineering, Quality, Safety Agency, and Manufacturing teams all contribute through the integrated product development process to create and deliver custom connectors that exceed our customers' needs and meet our high standards.

Contact your local customer service representative or regional sales manager to explore how our custom design and manufacturing capabilities can meet your high volume connection needs.

Product Selection Worksheet

Prior to selecting an interconnect solution, we recommend you gather the following information. This will aid you in quickly identifying the best product for your particular need.

Amps

Continuous _____
Peak _____

Max AMPS _____ Volts
Max AMPS _____ Seconds

Temperature

Operating _____

Storage _____

Circuit Definition

Number of Circuits:

Power _____
Ground _____
Auxiliary _____
Other _____

Wire Gauge:

Application

- PCB-to-PCB Wire-to-PCB Wire-to-Busbar Wire-to-Wire
 Wire-to-Panel Other _____

Mounting Method - If Applicable

- PCB Panel Blindmate

Contacts

- Mating Cycles _____ Individual Reeled
 Tin Silver Gold
 Straight Right Angle

Other Features

- Hot Plug Touch Safe Per _____
 Flame Resistance Per _____ IP Rating of _____
 Sequencing Strain Relief
 Polarized Housing Mechanical Housing Key
 Latching Handle
 Other

Anderson™ Tooling

Why Use of Anderson™ Recommended Tooling is so Important

Our connectors are designed to achieve the highest levels of durability, reliability, and performance as shown on the connector data sheets. Crimp tooling is a critical link between the designed performance of a connector and the realization of that performance by our customers.

As part of the connector design and testing process, we recommend a number of crimp solutions that have proven to deliver the intended connector performance in a process that is repeatable. Only these solutions tested by us are listed in the conditions of acceptability from safety agencies such as UL, CSA, and TUV.









Use of tooling solutions not tested by us can affect not only performance but safety agency approvals. Problems attributable to use of non approved tools include:

Electrical and Thermal

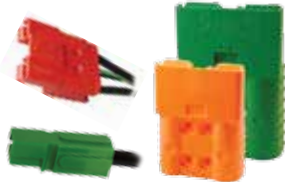
- High electrical resistance.
- Failure to realize designed current and voltage carrying capability.
- Overheating.
- Melting of connector housings.

Mechanical

- Contacts not able to fit inside connector housings.
- Contacts not seated properly in connector housings causing, shorts, intermittent circuits, abnormally high or low mating and unmating force, & low retention force of the contact in the housing.

| Crimp Tools Detail tooling charts are available at the end of each connector family section. |  |  |  |  |  |
|--|---|---|---|--|---|
| | PP15/455 | SB® 50 & PP75 | SBS® Mini | SBS® | PP120, PP180, SB®, SBE®, SBX® & SBO® |
| Press & Applicators  | • | • | • | | • |
| 1309 Series  | • | • | • | • | • |
| PM1000G1  | | | | • | • |
| TM0001  | | | | • | • |
| TP0001  | | | | • | • |
| 1387G1 & 1387G2  | | • | | • | • |
| 1368  | | | | | • |
| 1368-NL  | | | | | • |

1387G1 & G2 Pneumatic Bench Tools

Versatile & heavy duty tools manufactured by Pico Tools, use fixed depth dies and spring bottom locators designed specifically to crimp our contacts. Dies and locators are not interchangeable between the 1387G1 and the 1387G2. These pneumatic full cycle tools operate on clean and dry shop air pressures of 80 – 125 psi (5 – 8.6 BAR). See connector family tooling charts at the end of each section for the specific dies and locators recommended for crimping each contact. Dies and locators are available from Pico Tools for a variety of other terminal types including lugs, insulated terminals, and a variety of turned pin and socket contacts.

1387G1: 12 to 2/0 AWG (4 to 70 mm²)

Pico Tools Model 400-BHD
Compatible with M22520/23
dies and locators

1387G2: 12 AWG to 250 mcm (4 to 120 mm²)

Pico Tools Model: 500-D

1391G1: Foot Pedal Control

TA0002: Air regulator / filter for pneumatic tools.

Keeps air clean and dry for long lasting tool performance. Dial knob adjusts air pressure going to the tool.



1368 Series Hydraulic Tools

The dieless 4 indent head crimps full cycle until a minimum hydraulic pressure is reached. Good for crimping nearly all our contacts for wire sizes 4 AWG to 4/0, 300 mcm. The dieless system offers a highly flexible crimping system that does not require the purchase of separate dies and locators. Pressure based crimp depth allows these tools to be adapted to a broad range of large wire crimping needs including lugs, ring terminals, and splices.

1368: Hubbell VC7-SP dieless 4 indent tool with attached manual hydraulic pump. Tool includes a custom turret locator for positioning the PP120, PP180, SB® 120, SB® 175, SB® 350 contacts. The innovative design provides two separate crimp positions for the PP180, SB® 175 and SB® 350 contacts. Both the tool and locator ship in black plastic carrying cases.

1368-NL: Manufactured by DMC to our specifications, this 4 indent head with attached manual hydraulic pump offers the same crimping performance as the 1368, but with the cost savings of not having a custom turret locator. Includes black plastic carrying case.

| Contact Part Number | Description | Hand Tool | Automated Tooling | |
|---------------------|---|-----------|--------------------------------|------------|
| | | | Press | Applicator |
| 2003G1 | Receptacle Contact, Reeled | - | 115V = TE0101 230V = TE0102 | TD0104 |
| 2003G1-LPBK | Receptacle Contact, Loose Piece | 1309G9 | - | - |
| 2003G2-LPBK | Receptacle Contact, Loose Piece, 10 AWG | 1309G10 | - | - |



1309 Series Hand Tools

High quality hand tools are designed for crimping 6 to 20 AWG (13.3 to 0.52 mm²) wires for Powerpole®, SB®, SBS®, and SBE® / SBO® connectors. The extra long bright yellow handles provide significant crimping force while minimizing operator fatigue. Full cycle ratchet mechanism makes sure every crimp is fully completed. All tools except 1309G4 include a plastic locator piece that ensures proper positioning of the contacts for crimping.

1309G2: For crimping PP15/45 loose piece strip contacts and individual contacts.
 16 to 20 AWG (1.3 to 0.5 mm²)
 12 to 20 AWG (3.3 to 1.3 mm²)

1309G3: For crimping PP15/45 loose piece strip contacts from 10 to 16 AWG (5.3 to 1.3 mm²)

1309G6: For crimping PP15/45 loose piece strip contacts from 10 to 14 AWG (6.0 to 2.1 mm²) including high strand count superflex wires.

| Die & Locator Replacement | |
|---------------------------|--------|
| Tool | Kit |
| 1309G2 | 1310G2 |
| 1309G3 | 1310G3 |
| 1309G6 | 1310G6 |
| 1309G8 | 1310G8 |
| 1309G4 | 1310G4 |

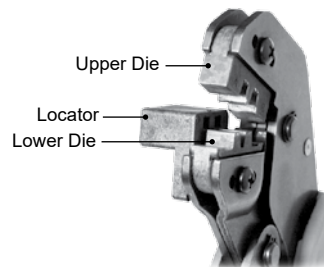

1309G8: Includes 1 tool frame with the appropriate dies and locators to make the 1309G2, 1309G3, and 1309G6 tools. Dies and locators are color-coded for easy identification and pairing. This combination allows the entire PP15/45 contact range to be crimped with one tool kit.

1309G4: For crimping PP75, SB® 50, SBE® 80, SBO® 60, and SBS® 50 and 75 power contacts. No locator included, follow crimp positioning specifications in assembly instructions. Tool is also used for crimping EBC auxiliary contacts.

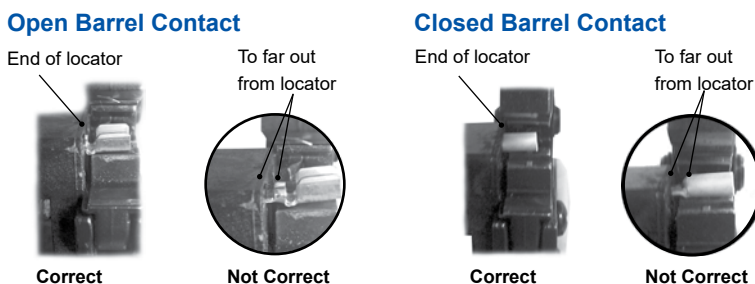

PM1000G1 Hand Tool

Versatile 4 indent hand tool with built in multi-position turret locator. Adjustable indenter depth features 0.01 mm adjustment increments to define the perfect crimp depth for wire sizes 10 to 26 AWG (6 to 0.14 mm²). Full cycle ratchet mechanism makes sure every crimp is fully completed. Use to crimp PowerMod® contacts used as auxiliaries in SBS® 75X and the 1x4 auxiliary connector as well as a wide range of other turned contacts including those for Power Drawer® and PPMX.



MIL-SPEC Hand & Bench Tools

Manual hand tools and pneumatic bench tools are available in this tool series. The hand and pneumatic tools both use the same turret locators designed specifically for APP® contacts. The interchangeable nature of the turret locators allow easy upgrades from prototyping to production volumes. All tools feature adjustable indenter depths to cover 12 to 26 AWG (3.3 to 0.25 mm²) capability. Full cycle mechanism makes sure every crimp is fully completed. See tooling charts at the end of each connector section for the appropriate turret locator part numbers.

TM0001: Rugged hand tool is qualified to MIL-DTL-22520/1. DMC Model AF8. Accessories shown are purchased separately.

TP0001: Pneumatic full cycle bench tool operates on clean and dry shop air pressures of 80 to 120 psi (5 to 8.3 BAR). This DMC model WA27F is compatible with optional bench mount and foot pedal control to increase operator speed and efficiency.

TA0001: Foot pedal control for TP0001

TA0002: Air regulator / filter for pneumatic tools. Keeps air clean and dry for long lasting tool performance. Dial knob adjusts air pressure going to the tool.

TA0003: Adjustable bench mount for TP0001



TA0002



TA0001



TM0001



TP0001

TA0003

Press & Applicator Tools

Press and Applicator tooling is available for high volume automated or semi-automated crimp termination of our reeled contacts for up to 10 AWG or 6 mm². All applicators have been designed to meet or exceed UL requirements. See connector family tooling charts at the end of each section for the specific press, air feed kit, and applicator recommended for crimping each contact.

| APP® Part Number | Description |
|------------------|---|
| TD0101 | Applicator for PP15/45 10 to 20 AWG Contacts |
| TD0102 | Applicator for PP15/45 10 to 14 AWG Super Flex Contacts |
| TE0102 | Press for Mini-Style Applicators 230V |
| TE0101 | Press for Mini-Style Applicators 115V |



"TE" Part numbers



"TD" part numbers

Crimping, Soldering, and Assembly Best Practices. Instructions for proper assembly are available for each connector and should be followed. These best practices are for reference only.

Stripping Wire Insulation

Problems with cable harness and connector systems often begin with improper or accidental cutting of wire strands when stripping wire insulation. Each strand is important, and all of them must be included in the contact barrel to avoid unnecessary hot spots during later operation. When removing insulation, position a sharp blade at a right angle and apply a steady controlled pressure cutting only the cable insulation and not the copper wire strands. Wires should be stripped to the lengths specified in the specific connector assembly instruction.

Cleaning Copper Wire

Copper oxide, a non-conductive material accumulates on copper wires exposed to oxygen and moisture. Aged and badly tarnished copper wire needs to be thoroughly cleaned to realize the rated performance of the connector and wire. Heavy oxidation can be scraped off with a stiff wire brush that penetrates the entire bundle and cleans every strand. For light surface oxidation a 3M Scotch Bright™ pad is recommended. The wires are ready for insertion into the contact barrel when they are burnished to their original bright copper finish. Contact barrels are lined with silver or tin plating to assure consistently high conductivity which will be reduced if the barrel is crimped around aged or tarnished wire.

Crimping

Our connectors are designed to achieve the highest levels of durability, reliability, and performance as shown on the connector data sheets. Crimp tooling is a critical link between the designed performance of a connector and the realization of that performance by our customers.

As part of the connector design and testing process, we recommend a limited number of crimp solutions that have proven to deliver the intended connector performance in a process that is repeatable. Only these solutions tested by us are listed in the conditions of acceptability from safety agencies such as UL, CSA, and TUV.

Use of tooling solutions not tested by us can affect not only performance but also safety agency approvals. Problems attributable to use of tools not recommended include:

Electrical and Thermal

- High electrical resistance.
- Failure to realize designed current and voltage carrying capability.
- Overheating.
- Melting of connector housings.

Mechanical

- Contacts not able to fit inside connector housings.
- Contacts not seated properly in connector housings causing: shorts, intermittent circuits, abnormally high or low mating and unmating force, & low retention force of the contact in the housing.

Soldering

The alternative to crimping is to solder all cable strands within the contact barrel. When using an open flame, make sure that you are not in an area where explosive gasses are present. The right proportion of solder is essential if this procedure is employed. Use a quality 60/40 solder (60 percent tin, 40 percent lead) in wire form with a rosin flux core. Cable strands should be separately fluxed with rosin paste, and the contact should be held in a vise with the barrel end facing up. Apply heat to the outside of the barrel while the solder flows in beside the wire strands.

Here are some things to avoid when soldering

- A. Don't use too much solder, to the point that it flows out of the contact barrel.
- B. Don't allow flux or solder on the outside of the contact. This will interfere with contact mounting within the installation or with the contact connection to a mating connector.
- C. Don't overheat and cause excessive solder to "wick" up into the cable and stiffen it. This could interfere with contact flexibility when connectors are mated.
- D. Don't solder when contact is in the connector housing. Solder away from the housing and then insert the contact into the housing after it has cooled.

NOTE: Underwriters Laboratories (UL) requires the use of a cable clamp for soldered connections to unsupported wires.

Determining if a Good Crimp Has Been Made

1. Assure the correct wire size and type is used for the specific contact being crimped.
2. Follow the assembly instructions for the connector. Special attention should be paid to wire preparation and stripping.
3. Use the correct application tooling we recommend (tool, die, & locator).
4. Make several crimps for testing, and record crimp dimensions in both "x" and "y" planes.
5. Test the electrical resistance across a mated pair of connectors to the standard of the information provided on the data sheet.
 - a. The electrical resistance values should be similar to (or less than) what we publish for that connector in our catalogs. Please see the "Avg. Mated Contact Resistance" on the data sheet for the specific connector.
6. Test the pull out strength per the table to the right.
 - a. To achieve the electrical performance published in our literature the pull out values at minimum should meet the UL 486A values for the wire size being used. The first column (lower value) pull out is the minimum per UL486A. The second column is what APP® tries to achieve when designing our crimp solutions. Any force within this range is acceptable.
7. If crimps are within electrical and mechanical specifications then the crimp dimensions are suitable to be used as a secondary inspection criteria.

| Wire Size AWG or MCM | Lbf Contact Retention Force Range | kgf Contact Retention Force Range |
|-------------------------|---|---|
| 22 | 8 to 12 | 3.6 to 5.4 |
| 20 | 13 to 16 | 5.9 to 7.3 |
| 18 | 20 to 30 | 9.1 to 13.6 |
| 16 | 30 to 40 | 13.6 to 18.1 |
| 14 | 50 to 60 | 22.7 to 27.2 |
| 12 | 70 to 85 | 31.8 to 38.6 |
| 10 | 80 to 125 | 36.3 to 56.7 |
| 8 | 90 to 180 | 40.8 to 81.6 |
| 6 | 100 to 200 | 45.4 to 90.7 |
| 4 | 140 to 280 | 63.5 to 127 |
| 3 | 160 to 320 | 72.3 to 145.1 |
| 2 | 180 to 360 | 81.6 to 163.3 |
| 1 | 200 to 400 | 90.7 to 181.4 |
| 1/0 | 250 to 500 | 113.4 to 226.8 |
| 2/0 | 300 to 600 | 136.1 to 272.2 |
| 3/0 | 350 to 700 | 158.8 to 317.5 |
| 4/0 | 450 to 775 | 204.1 to 351.5 |
| 250 | 500 to 800 | 226.8 to 362.9 |
| 300 | 550 to 800 | 249.5 to 362.9 |

Why Crimp Dimensions are not Suitable as Primary Inspection Criteria

Crimp dimensions are not an adequate or reliable means to evaluate if a good crimp has been made. For this reason they should not be relied upon as a primary inspection method.

When you crimp a contact, the material is forced down to the size of the fully closed die. This die closure on most tools is a fixed dimension. When the die is released, the material (contact and wire) will expand back out when they are no longer restrained by the die. The amount that it expands outwards or “bounces back” is dependant on the resistance or force that the material in the contact and wire places against the crimp die. The resistance of the material to being formed by the crimp will vary with wire type and stranding, hardness of the metal (both contact and wire), as well as the temperature. It is for this reason that the crimp height is a variable and cannot be relied upon solely to determine if a crimp is good or not.

Crimp Dimensions as Secondary Inspection Criteria

Crimp dimensions should only be used as secondary inspection criteria due to the above variables. These variables make it impossible for us to determine what the correct crimp dimension should be without evaluation of the specific instance. Accordingly harness manufacturers are responsible for determining the appropriate crimp dimensions to be used and only as a secondary inspection method. Crimp dimensions are an acceptable means of short interval inspection for determining homogeneity within a batch provided:

1. Electrical resistance and pull out strength are tested on samples from the batch to ensure the crimp dimensions are indicative of a good crimp.
2. The same tooling is used throughout the batch and operated in the same manner, at the same calibration level.
3. The same wire is used throughout the batch. (Wire can vary significantly by factors ranging from class to manufacturer).
4. Assembly instructions are closely followed, especially wire stripping and preparation.

Other Critical Crimp Dimensions

There are other critical crimp dimensions that impact if a crimp is good or not. All contacts are designed to work with a specific crimping solution to minimize the distortion of crimping force on the critical geometries of the contact. If the incorrect crimp solution is used or the correct crimp solution is improperly used, then this will distort the intended geometries of the contact.

The geometry of the contact blade and its relative angle to the crimp barrel must be maintained after the contact is crimped. If these dimensions are not maintained the contact will not latch properly in the housing. This can impact how well the contact is secured in the housing as well as the normal force (measurement of the opposing force that pushes the contacts together) between the mating blades of two mating contacts. The normal force is directly related to the electrical properties of the connector and poor normal force can lead to higher electrical resistance, overheating, and reduced current capability. These geometries can only be assured by using the correct crimp tool, with proper die and locator.

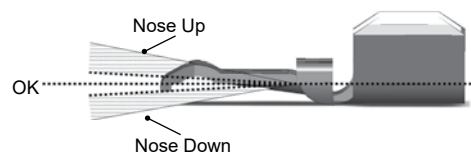

Technical Reference

General Application Notes

There are common considerations when using our connectors. Additional considerations may apply based on the particular connector being used, the application, and conditions in which it's being used. This information is intended to provide a basic understanding and is provided for reference only. Connectors should be assembled and used according to the equipment and the manufacturer's instructions, as well as in compliance with local and international electrical codes.

The maximum amperage ratings provided in the specifications are based on use of our recommended assembly tooling and the maximum wire size for the connector being used. Amperage ratings are based on not exceeding the maximum operating temperature of the connector housing, factoring in an ambient temperature of 25°C or 77°F. A wire with an appropriate insulation temperature rating should be selected to meet or exceed the total connector temperature (heat rise + ambient).

As an example: if the maximum operating temperature for a connector operation is 105°C and the ambient temperature is 25°C, the maximum heat rise attributable to the connector is 105°C - 25°C = 80°C. The expected heat rise based on the connector and wire size used can be estimated using the heat rise charts, but should be confirmed by testing in the specific application with the specific wire to be used.

Connector devices are rated or derated by the wiring configuration and the environment. Factors to be considered include: enclosure characteristics, connector housing and wire insulation characteristics, number of wires in an enclosed area such as a raceway or conduit, as well as the ambient temperature.

Underwriter Laboratories Inc. amperage ratings are based on not exceeding the maximum operating temperature of the connector housing. This means connectors can be extremely hot when used at the UL amperage ratings. For this reason UL amperage ratings should only be applied to connectors when they are used inside an enclosure not accessible to untrained persons. Canadian Standards Association ratings are based on not exceeding a 30°C temperature rise above ambient temperatures. For this reason CSA amp ratings are a good point of reference for connectors that are user operated. APP® does not recommend exceeding a 30°C temperature rise above ambient temperatures for connections accessible during operation to untrained persons.

How to Read Temperature Charts

Temperature Rise Charts are Based on a 25° Ambient Temperature

Temperature Rise at Constant Current charts show the associated heat rise as a result of applied current to the connector. An example of the SB® 50 connector Temperature Rise chart is included to follow along with this explanation.

The chart is based on an ambient temperature of 25°C (77°F room temperature). Accordingly if the temperature °C on the Y axis of the chart is at 30°C, the expected total connector temperature would be 55°C.

Separate curves are shown for 6, 8, 10, and 12 AWG wire. Interpreting the curves, if 50 amps are applied continuously to the connector, the heat rise will be 23°C for 6 AWG, 35°C for 8 AWG, 55°C for 10, and 12 AWG wire is not suitable for this amperage.

Where T = Temperature, heat rise is expressed as a $\Delta T^{\circ}C$.
 $T_{\text{ambient}} - T_{\text{ambient}} + \text{heat from applied current} = \Delta T^{\circ}C$.

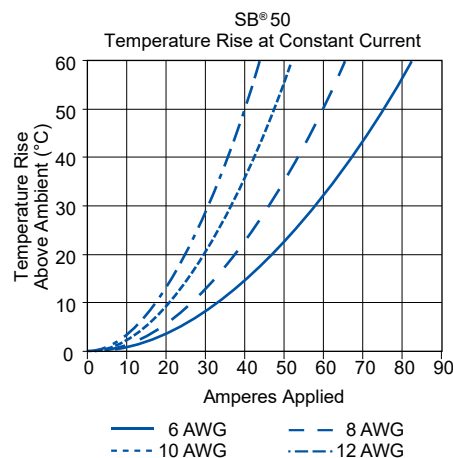

Derating vs. Ambient Temperature Charts

Derating vs. Ambient Temperature charts show the maximum amperage capability of a connector at a given ambient temperature. An example of the SB® 50 connector chart is included to follow along with this explanation.

All data points are based on the maximum operating temperature of the connector, most often 105°C or 221°F. Accordingly if the temperature °C on the Y axis of the chart is at 105°C, there is no amperage capability because the connector housing is already at the maximum operating temperature.

Separate curves are shown for 6, 8, 10, and 12 AWG wire. Interpreting the curves, at a 75°C ambient temperature the maximum amperage capability that can be applied continuously to the connector is: 58A for 6, 46A for 8, 37A for 10, and 31A for 12 AWG.

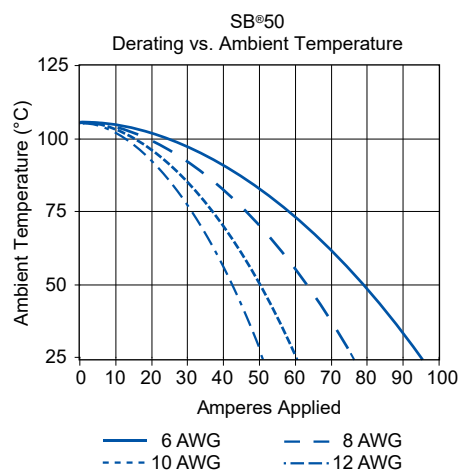

Notes on Temperature Rise Charts

Note that these charts are constructed using calculations based on actual test data. For this reason the chart information may vary slightly from the safety agency ratings. Safety agency ratings and compliance with electrical codes take precedent over these charts. The charts are designed to provide a guideline as to the connectors' capability. Actual results can vary based on the specific wire used, crimp tooling and assembly, as well as the environment the connector is used in.

CSA ratings are based on not exceeding a 30°C temperature rise above ambient or a total temperature of 55°C. This is considered the maximum temperature to safely handle a connector at. UL ratings can be based on the operating temperature limit of the connector. Often for our connectors this is 105°C or an 80°C temperature rise above an ambient temperature of 25°C. To provide a margin of safety, the heat rise charts are limited to a 60°C temperature rise.

Compatible Wires

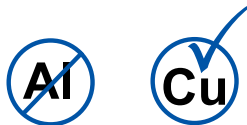

Our connectors are designed to be crimped or soldered to multi-stranded copper conductor wires only. Alternate conductor materials including aluminum should not be used. Aluminum conductors crimped into our contacts can result in a galvanic reaction occurring between the aluminum wire and the more cathodic metals used in our contacts including copper, tin, silver, and gold. Additionally softer metals like aluminum flow or loosen from crimps much easier than copper.

Multi-stranded wire is recommended for all our connectors and is required when crimp terminating wires or when a connector with flat wiping contact technology is used (such as Powerpole® and SB®). Solid wires do not adequately compress and retain in crimp barrels after being crimped. For this reason if solid wire is used, it should be with solder termination only.

Solid wires also do not flex and bend as easily as multi-stranded equivalents and can act as a lever arm and impede or alter the natural state of a flat wiping contact in the housing. This impediment or alteration to the flat wiping contact's natural state can cause intermittency and shorts as well as higher resistance and temperature at a given amperage than is shown in the specifications. Mating and unmating forces may also be impacted.

Different Contact Technologies

Flat Wiping

- Same contacts on the “male” and “female” side reduce inventory costs and increase ease of assembly.
- Low resistance connection has a large conducting surface and a high normal force in comparison to typical pin and socket contacts.
- Sacrificial tip confines damage to non-conducting area when mating or breaking under load.
- Raised surface on the mating side of the contacts secures the connector in the mated condition, limiting the need for latching on outer housings.
- Over wiping design cleans the mating surface when mating and unmating.

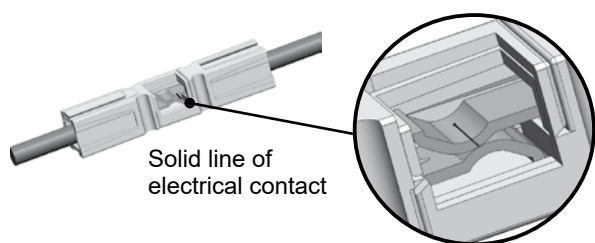

Flat Wiping Technology

**Altered Housing
for Reference Only**

- VS -

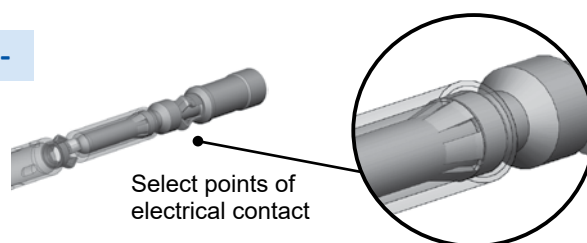

Pin & Socket Technology

Good Condition

Pin & Socket

- Different contacts on male and female sides. Female socket contacts are typically more expensive than the simple geometries of the pin contacts.
- Often higher resistance than flat wiping connectors of the same wire size and plating due to the reduced mating surface area and lower normal force. Gold plating often used to compensate and minimize resistance.
- Best for compact connection needs such as signal and low power due to static position in housings and symmetrical shape.
- Socket contacts can catch and hold debris inside the socket body causing mating problems.

Use of Anderson™ Connectors in Applications Exceeding 600V

The approved voltage ratings for our connectors are usually limited by the category under which a safety agency such as UL approves our connector for use. UL typically defers to National Electric Code (NEC) on the voltage limitations for any given device our connector could be used in. For most common applications NEC restricts voltage to a maximum of 600V AC/DC which is what our connector voltage ratings are based on.

To achieve UL 1977 approval for a 600V rating, we test our connectors for dielectric withstanding voltage. The connector is tested at 2 times the rated voltage of 600V plus 1000V or 2200VAC for 1 minute. For applications exceeding 600V, UL / NEC / IEC may require application specific review for creepage and clearance resistance.

Touch Safety & Ingress Protection (IP68)

UL 1977 Section 10.2

Typically required for applications where the connector is external to the end device and operating over 30V or 200A, where wet conditions may be present (600V category).

Testing is performed using a probe that mimics a child's finger. All features of the connector are tested for live parts in the unmated state (no pressure applied). A smaller 3 mm probe is then applied in the mated state to test for live parts. Note that some applications may require the connector to not expose live parts to the 3 mm probe in the mating interface.

IEC 60950

From the standard for Information Technology Equipment Safety, the requirements are harmonized with UL1950. Typically required for commercial and industrial applications where operators may need some degree of protection while accessing or servicing equipment.

Testing is performed using a probe that mimics an adult finger. All features of the connector are tested for live parts in the unmated state with 30 N of force applied to the probe.

IEC 60529

Standard for Degrees of Protection Provided by Enclosures is harmonized with EN 60529.

Protection degree number is assigned to both solids and liquids in that order. For example: a connector with an IP20 rating is protected against fingers, but has no protection against ingress of liquids. We take a conservative approach in rating our connectors against liquid ingress and consider any meaningful water ingress to have a harmful effect.

| Protection Degree | Solids (first digit) | | Liquids (second digit) | |
|-------------------|----------------------|--|--|---|
| | Description | Protected Against | Description | Protected Against |
| 0 | Not Protected | | Not Protected | |
| 1 | > 50 mm | Large body part such as back of hand | Vertically dripping water (no harmful effect) | Duration: 10 minute Water: 1 mm / minute rainfall Pressure: N/A |
| 2 | > 12.5 mm | Adult fingers or similarly sized objects | Tilted 15 degrees up dripping water (no harmful effect) | Duration: 10 minute Water: 3 mm / minute rainfall Pressure: N/A |
| 3 | > 2.5 mm | Typical screw drivers or large wires | Water spray up to 60 degree angle (no harmful effect) | Duration: 5 minute Water: 0.7 liter / minute Pressure: 80 - 100 kN/m ² |
| 4 | > 1 mm | Small pointy tools and small wires | Water splash from any direction (no harmful effect) | Duration: 5 minute Water: 10 liter / minute Pressure: 80 - 100 kN/m ² |
| 5 | Dust Protected | Complete physical protection, no functional interference from dust | Water jet from any direction (no harmful effect) | Duration: 3+ minute Water: 12.5 liter / minute Pressure: 30 kN/m ² @ 3 m distance |
| 6 | Dust Sealed | Complete physical protection and sealed from dust ingress | Strong water jet from any direction (no harmful effect) | Duration: 3+ minute Water: 100 liter / minute Pressure: 100 kN/m ² @ 3 m distance |
| 7 | N/A | | No ingress of water in harmful quantity when immersed up to 1 m depth | Duration: 30 minute Water: Immersion Pressure: 1 m depth |
| 8 | | | No ingress of water in harmful quantity when subject to tests in excess of condition 7 | Duration: Mfg. specified Water: Immersion Pressure: 1 + m depth, Mfg. specified |

Preventative Maintenance

Damaged connectors, contacts and cables may present hazards, resulting in inefficient battery and charger operation. To avoid these problems, conduct the following maintenance checks at least once annually. If you see any of the following problems, take corrective action immediately.

1. Dirty Connectors

When engaged and disengaged, the contact surfaces of Anderson™ flat wiping connectors “over wipe,” thus providing self cleaning action. To ensure the continued benefit of this feature, clean the contact surfaces and lubricate the connectors. Use a “white” lithium grease, which may be obtained from hardware stores and automotive parts suppliers.

2. Melting Connectors

Connector housings overheat and melt for many reasons. To prevent this:

- A. Examine the crimp between cable and contact. Ensure the crimp tooling recommended by Anderson™ has been used. Improper crimping, corrosion, and broken wires result in unnecessary resistance causing the contact to heat up.
- B. Check contact surfaces for signs of “pitting” caused by dirt or disengaging connectors under load. One badly pitted contact, particularly in a connector attached to a battery charger, can lead to pitting on surfaces of other contacts. If not corrected, this can result in an epidemic of bad connectors throughout a fleet of electric vehicles and in chargers and batteries.
- C. Check to see if batteries are being disconnected while the charger is still on. This causes the contacts to arc at the tips, resulting in progressive pitting and silver removal from tip to crown. If this practice is occurring, it should be discontinued to avoid major repairs in the future.

3. Other Conditions

If any of the following conditions exist, the connector housing, contact and / or cable should be replaced immediately.

- A. Housing - Cracks, missing pieces, evidence of excessive heat, discoloration. You may consider replacing the existing housing with a Chemical Resistant equivalent for improved durability against UV rays and common solvents and hydrocarbons.
- B. Contacts - Pitting, burns, corrosion, excessive wear and cracked crimp barrels, as shown in image “B”.
- C. Cable - Exposed copper near housing, cracked cable, peeling or frayed insulation.
- D. Handles - Loose attachment and signs of damage as missing or loose hardware and cracked or broken plastic (Handles should be used for connectors that are hard to reach or move).
- E. Cable Clamps - Loose attachments, signs of abraded cable jacket, missing or loose hardware. (Cable clamps should be used to relieve strain on unmounted cable).



Engineering Reference

Conversion Chart for American Wire Gauge to Metric System

| AWG Size | Metric mm ² | Circ. Mils | Equivalent Circ. Mils | Approximate Wire Diameter | |
|----------|------------------------|------------|-----------------------|---------------------------|------|
| | | | | in. | mm |
| - | 0.5 | - | 937 | 0.032 | 0.81 |
| 20 | - | 1020 | - | 0.036 | 0.91 |
| - | 0.75 | - | 1480 | 0.039 | 0.99 |
| 18 | - | 1620 | - | 0.046 | 1.16 |
| - | 1 | - | 1974 | 0.051 | 1.30 |
| 16 | - | 2580 | - | 0.051 | 1.29 |
| - | 1.5 | - | 2960 | 0.063 | 1.60 |
| 14 | - | 4110 | - | 0.073 | 1.84 |
| - | 2.5 | - | 4934 | 0.081 | 2.06 |
| 12 | - | 6530 | - | 0.092 | 2.32 |
| - | 4 | - | 7894 | 0.102 | 2.59 |
| 10 | - | 10380 | - | 0.116 | 2.93 |
| - | 6 | - | 11840 | 0.126 | 3.21 |
| 8 | - | 16510 | - | 0.146 | 3.70 |
| - | 10 | - | 19740 | 0.162 | 4.12 |
| 6 | - | 26240 | - | 0.184 | 4.66 |
| - | 16 | - | 31580 | 0.204 | 5.18 |
| 4 | - | 41740 | - | 0.232 | 5.88 |
| - | 25 | - | 49340 | 0.260 | 6.60 |
| 2 | - | 66360 | - | 0.292 | 7.42 |
| - | 35 | - | 69070 | 0.305 | 7.75 |
| 1 | - | 83690 | - | 0.332 | 9.43 |
| - | 50 | - | 98680 | 0.365 | 9.27 |

| AWG Size | Metric mm ² | Circ. Mils | Equivalent Circ. Mils | Approximate Wire Diameter | |
|----------|------------------------|------------|-----------------------|---------------------------|-------|
| | | | | in. | mm |
| 1/0 | - | 106 mcm* | - | 0.373 | 9.46 |
| 2/0 | - | 133 mcm* | - | 0.419 | 10.60 |
| - | 70 | - | 138.1 mcm | 0.430 | 10.90 |
| 3/0 | - | 168 mcm* | - | 0.471 | 12.00 |
| - | 95 | - | 187.5 mcm | 0.504 | 12.80 |
| 4/0 | - | 212 mcm* | - | 0.528 | 13.40 |
| - | 120 | - | 237.8 mcm | 0.567 | 14.40 |
| - | - | 250 mcm | - | 0.575 | 14.60 |
| - | 150 | 300 mcm | - | 0.630 | 16.00 |
| - | - | 350 mcm | - | 0.681 | 17.30 |
| - | 185 | - | 365.1 mcm | 0.700 | 17.80 |
| - | - | 400 mcm | - | 0.728 | 18.50 |
| - | 240 | - | 473.6 mcm | 0.801 | 20.30 |
| - | - | 500 mcm | - | 0.814 | 20.70 |
| - | 300 | - | 592.1 mcm | 0.891 | 22.60 |
| - | - | 600 mcm | - | 0.893 | 22.70 |
| - | - | 700 mcm | - | 0.964 | 24.50 |
| - | - | 750 mcm | - | 0.999 | 25.40 |
| - | 400 | - | 789.4 mcm | 1.026 | 26.10 |
| - | - | 800 mcm | - | 1.032 | 26.20 |
| - | 500 | - | 986.8 mcm | 1.152 | 29.30 |
| - | - | 1000 mcm | - | 1.153 | 29.30 |
| - | 625 | - | 1233.7 mcm | 1.287 | 32.70 |

* Rounded for simplicity

NOTE: The above wire diameters and circular mils are based on an average of the most commonly available wires. The wire manufacturer's specification should be referenced for information specific to the wire being used.

Volts • Amps • Ohms • Watts Conversion

| E (volts) | I (amps) | R (ohms) | W (watts) |
|---------------|----------------------|-----------------|-----------------|
| \sqrt{WR} | $\frac{E}{R}$ | $\frac{E}{I}$ | EI |
| $\frac{W}{I}$ | $\sqrt{\frac{W}{R}}$ | $\frac{W}{I^2}$ | I^2R |
| IR | $\frac{W}{E}$ | $\frac{E^2}{W}$ | $\frac{E^2}{R}$ |

Volts = $\sqrt{\text{Watts} \times \text{Ohms}}$

Amperes = $\frac{\text{Volts}}{\text{Ohms}}$

Ohms = $\frac{\text{Volts}}{\text{Amps}}$

Watts = Volts x Amps

Volts = $\frac{\text{Watts}}{\text{Amps}}$

Amperes = $\sqrt{\frac{\text{Watts}}{\text{Ohms}}}$

Ohms = $\frac{\text{Watts}}{\text{Amps}^2}$

Watts = Amps² x Ohms

Volts = Amps x Ohms

Amperes = $\frac{\text{Watts}}{\text{Volts}}$

Ohms = $\frac{\text{Volts}^2}{\text{Watts}}$

Watts = $\frac{\text{Volts}^2}{\text{Ohms}}$

Wattage Varies Directly as a Ratio of Voltages Squared

$$W^2 = W^1 \left(\frac{E^2}{E^1} \right) \times^2$$

3 Phase Amperes = $\frac{\text{Total Watts}}{\text{Volts} \times 1.732}$

Standard to Metric Conversions

| Approximate Conversions From: Standard / US Customary To: SI / Metric Units | | | | |
|---|----------------------------|-----------------------------------|--------------------|-----------------|
| Symbol | When You Know | Multiply By | To Find | Symbol |
| LENGTH | | | | |
| in | Inches | 25.4 | Millimeters | mm |
| ft | Feet | 0.305 | Meters | m |
| AREA | | | | |
| in ² | Square Inches | 645.16 | Square Millimeters | mm ² |
| ft ² | Square Feet | 0.093 | Square Meters | m ² |
| VOLUME | | | | |
| fl oz | Fluid Ounces | 29.57 | Milliliters | mL |
| gal | Gallons | 3.785 | Liters | L |
| ft ³ | Cubic Feet | 0.028 | Cubic Meters | m ³ |
| MASS | | | | |
| oz | Ounces | 28.35 | Grams | g |
| lb | Pounds | 0.454 | Kilograms | kg |
| TEMPERATURE | | | | |
| °F | Fahrenheit | (F-32) x 5 / 9 or (F-32) / 1.8 | Celsius | °C |
| FORCE AND PRESSURE OR STRESS | | | | |
| lbf | Poundforce | 4.45 | Newtons | N |
| lbf/in ² | Poundforce per Square Inch | 6.89 | Kilopascals | kPa |

| Approximate Conversions From: SI / Metric Units To: Standard / US Customary | | | | |
|---|---------------|--------------------------------|-----------------------------|---------------------|
| Symbol | When You Know | Multiply By | To Find | Symbol |
| LENGTH | | | | |
| mm | Millimeters | 0.039 | Inches | in |
| m | Meters | 3.28 | Feet | ft |
| AREA | | | | |
| mm ² | Millimeters | 0.0016 | Square Inches | in ² |
| m ² | Square Meters | 10.764 | Square Feet | ft ² |
| VOLUME | | | | |
| mL | Milliliters | 0.034 | Fluid Ounces | fl oz |
| L | Liters | 0.264 | Gallons | gal |
| m ³ | Cubic Meters | 35.315 | Cubic Feet | ft ³ |
| MASS | | | | |
| g | Grams | 0.035 | Ounces | oz |
| kg | Kilograms | 2.205 | Pounds | lb |
| TEMPERATURE | | | | |
| °C | Celsius | (C/5) x 9 + 32 C x 1.8 + 32 | Fahrenheit | °F |
| FORCE AND PRESSURE OR STRESS | | | | |
| N | Newtons | 0.225 | Pound-force | lbf |
| kPa | Kilopascals | 0.145 | Pound-force per Square Inch | lbf/in ² |

Frequently Asked Questions

Can I cross mate low and high mating force contacts?

Yes, however this would not be a connection solution we have tested for safety agency approval. Additionally the contacts may wear at an accelerated rate causing the mating cycle rating to be reduced. The mating and unmating force expected would be somewhere in between the high and low mating force specification.

Can I crimp multiple wires into 1 crimp barrel?

Yes, however this would not be a connection solution we have tested for safety agency approval. Particular care should be used that the bundle of wires do not interfere with the movement of the contact in the housing during mating and unmating (see maximum wire O.D. specification). The total circular mils of all conductor strands should be within + or – 5% of the wire size the contact is intended for. Twist the conductor strands together and crimp using our tooling with range taking capabilities such as the 1368 series. To crimp with other Anderson™ recommended tools, contact customer service for the recommended setting or die and locator combination.

Will the crimp tool I have for standard color-coded lugs, Mil Spec contacts, or another connector manufacturer, work for crimping Anderson™ contacts?

No. Our contacts generally do not conform to standard crimp barrel dimensions used for lugs, Mil Spec contacts, or other connector manufacturers. In some instances Mil Spec tools are approved for crimping contacts with the dies and locators recommended by us. See tooling charts for specific instances, or contact customer service for more information. The tooling recommended by us must be used to ensure the performance designed by us is achieved. Alternate tooling will void our warranties and can affect safety agency approvals.

Can metric sized wires be used with Anderson™ contacts?

Yes. The majority of our crimp tooling recommendations are based on testing and verification we have performed with AWG sized cables. Metric cables of the same or slightly smaller circular mils equivalent to the AWG wire recommended can typically be successfully terminated in our contacts. There is a wire conversion chart under Engineering Reference Section in the catalog that can be used as a reference when converting AWG to mm² sizes. The 1368 series crimp tooling has a range taking capability that produces a reliable crimp with metric equivalents of AWG cables. Please contact customer service for metric tooling recommendations for other Anderson™ crimp tools.

Are Anderson™ connectors suitable for use in applications where the voltage exceeds 600V AC/DC?

Possibly. See “Use of Anderson™ Connectors in Applications Exceeding 600V”, or contact Customer Service with further questions.

How do Powerpole® and Multipole connectors stay securely mated without latches?

The proven flat wiping technology used in these connectors features a detent or bump in the contact surface along with powerful stainless steel springs that hold the connectors in the mated position. High mating force contacts have a detent that is raised higher than low mating force contacts. The higher the detent, the more force is required to mate and unmate the contacts. In many applications the detent and spring force is enough to securely hold the connectors in the mated position without the need for latches. Latching shells, clips, or other external devices can be used to secure flat wiping connectors in applications where shock, vibration, or cable strain may overcome the inherent force holding the connectors together.

How does Anderson's genderless connector design work to make a mated pair?

To make a mated pair of Powerpole® or Multipole connectors simply assemble the connectors closely following the assembly instructions. After each connector half is fully assembled take one half and flip it over. The two halves will mate together. Multi-row Powerpole® assemblies will need to be stacked in mirror images of each other to properly mate the correct circuits. This information is detailed at the beginning of the Powerpole® section.

Genderless Powerpole® and Multipole housings do not have a male(pin) and female(socket) side. For wire-to-wire applications the exact same housings and contacts are used on both sides of the mated pair. If your application calls for wire-to-PCB or wire-to-busbar connections then different contacts and possibly housings will be required on each half (similar to male and female connectors).

May I mate same housing colors but have different size contacts in the housings?

Yes. You may mate the housings together if they have different wire or contact sizes; however, the amperage will derate down to the lowest wire gauge.

Where do I locate information on the crimp tool that is qualified with the housing and contact being used?

Information can be found by going to the data sheet for the product you are using. To find these select the product pages tab at the top of the website; select product category; select learn more; select technical information and choose appropriate data sheet then scroll to last page to find the tooling chart. The chart will show details on which crimp tools are approved for each of the contacts and housings.

What rules should I follow for crimping if I am not using Anderson's recommended tooling?

If you choose not to use approved and tested Anderson Power Products® tooling, then it is recommended that you refer and follow the crimp specification guidelines for the product you are using. Crimp specifications can be found under the technical area on the product pages for each product category. The use of tooling not recommended by APP® can affect performance and may void the APP® product warranty as well as invalidate safety agency approvals or certifications.

How do I order Anderson Power Products® Parts?

There are two ways to order

- 1) Through an authorized distributor <https://www.andersonpower.com/us/en/where-to-buy.html>
- 2) On the Anderson Power Products® webstore with a credit card. NOTE: Not all items may be available thru our webstore. If the item, you wish to purchase isn't available you can contact our customer service team at (978) 422-3800.

Where do I find 3D drawings?

To locate a 3D drawing, select the Learn More button from the connector product you wish to inquire about at the address below, and then select 3D files button. We do not provide 3D drawings of contacts. <https://www.andersonpower.com/us/en/ProductPages.html> You must be registered on the website and logged in to download a 3D file. If there is not a 3D file on the website for the product you are looking for, please contact tech support for assistance ustechsupport@andersonpower.com

What is the difference between a dust vs boot cover?

Dust covers prevent dirt and dust from entering the mating interface when not connected. Boots provide water, dirt, chemical and UV protection for the connectors in both mated and unmated conditions and are rated for Ingress Protection.

What are finger proof housings? Can I mate them with non finger proof housings?

Finger proof housings add a level of safety to our products. There are ribs on the mating interface that protect against accidental exposure to live contacts and meet UL standards. Finger proof housings should never be mated with non finger proof housings. Forcing these together will cause damage to the housings.

What is the function of reducer bushings with the contacts?

Bushings reduce the inner diameter of the contacts to accept a smaller wire gage. If the wire is too small for the contact being used we may offer a reducer bushing. Reducer Bushings are available to be used with specific contacts. Bushing part numbers can be found on the data sheet for each product. Please note that usage of a bushing with a contact that has not been agency tested for approval.

How many volts are your connectors rated for?

Most APP® products are rated for 600 volts per UL 1997. Please see specific data sheet for specific ratings.

I need to qualify that the connectors I have are true APP® connectors?

The only way to guarantee you have true APP® connectors is to purchase from one of our authorized distributors or from our webstore.

Why are the SB®/ SBS® / SBE® / SBX® Connectors color-coded and keyed?

Anderson™ has developed different mechanical keys that coincide with the National Electric code voltage level to prevent incompatible voltages from being cross mated. Note however the mechanical keying and color does not restrict the voltage capability of the connector. Most of APP® connectors are rated to 600 volts per UL 1977 (see data sheet for specific ratings).

May I mate connectors together that have low and high mating force contacts?

Yes. However, APP® has not tested this for safety regulation approval, and it should be noted that the contacts will wear at an accelerated rate causing the mating cycles to be reduced. Since the user is mating low and high force contacts the mating force would be somewhere in between what is listed for the high and low mating specification.

Should I mate housings together without contacts?

Anderson™ connector housings are designed to be mated only when crimped or soldered contacts are installed within the housing. Please do not attempt to mate the housings unless the contacts are installed. If you attempt to mate the housings without crimped contacts installed, you could damage the housing or spring.

Can I mate Anderson™ housings with a non-Anderson housing?

Only Anderson™ housings should be mated with each other. Mating Non-Anderson parts with Anderson™ products will void UL certifications, warranties, and liability if an incident should occur.

I have connectors that are melting. What might be the cause?

Connectors can show signs of melting for many reasons. Sometimes melting can occur by improper crimping, having damaged or broken wires; use of unapproved tooling, signs of corrosion or in some cases using a connector or wire size not properly sized for your application.

Can I solder contacts instead of crimp?

Yes, soldering can be used as an alternative to crimping. Directions are listed on the assembly document for each connector.

Where do I locate data sheets, drawings, assembly documentation, tooling and crimp specs for each product line?

Please reference the learn more tab on the Product Pages found at the following location.

<https://www.andersonpower.com/us/en/ProductPages.html>

Where do I locate ROHS and REACH documentation and other certifications?

Please reference the Resource tab on the website. Most certifications can be located there.

<https://www.andersonpower.com/us/en/resources.html>

Do you have videos of your connectors?

Videos can be found at the following link for APP® connectors.

<https://www.youtube.com/user/AndersonPowerP>

Glossary of Terminology

Amp / Ampere - Measurement increment of electric current. Abbreviated as “I”.

Applicator - A semi-automatic termination machine consisting of an upper and lower half that is used to crimp contacts onto wire. Used in conjunction with an electrical / mechanical press.

AWG - American Wire Gauge. A standard system for designating wire diameters.

Blindmate - To join two connector halves in a normal engaging mode without visual orientation.

Busbar - Three dimensional constructions enabling electrical distribution of current in power electronic modules. Typically constructed of copper, busbars are most frequently used in power dense applications where the busbar offers a cost or space savings over wire.

Color Coding - A system of identification for terminals housings; and related devices.

Contact Resistance - The electrical resistance of metallic surfaces at their interface in the contact area under specified conditions when carrying a specified test current.

Contact Retention - Minimum axial load in either direction which a contact must withstand while remaining firmly fixed in its normal position within a housing.

Crimp Retention - The axial load which a contact can withstand without separation from the wire.

Crimp Termination - A connection in which a metal sleeve is secured to a conductor by mechanically deforming the sleeve with presses or automated crimping machines, eliminating the need for solder. Not suitable for solid (non-stranded wires).

CSA - Canadian Standards Association, a safety standard writing and testing organization, providing service to Canada, US, Europe and worldwide.

Cycle Controlled - To determine if repetitive on or off conditions result in degrading the contact system which may lead to failures such as “thermal run away”.

Detent - A bump or raised section projecting from the surface of a contact for keeping the contact in position relative to another and released by greater force.

Dielectric Strength (Withstanding Voltage) - The highest potential difference (voltage) that an insulation material of given thickness can withstand for a specified time without occurrence of electrical breakdown through its bulk.

Finger Proof - A connector intended for usage external to the end equipment shall have live parts protected against exposure to contact by persons when assembled, installed, and mated as intended, as determined by UL Articulated Probe.

Flammability - The measure of a material’s ability to support combustion. Often tested per UL94.

Flat Wiping - The sliding action which occurs when contacts are mated. Wiping has the effect of removing small amounts of contamination from the contact surfaces, thus establishing better conductivity.

Genderless - A connector in which both mating members are exactly alike at their mating face. There are no male or female members, but designs provide correct polarity.

Heat Rise - Temperature rise associated with the electrical load applied to a mated connection.

Hermaphroditic (Genderless) Connector - A connector in which both mating members are exactly alike at their mating face. There are no male or female members, but designs provide correct polarity.

Hot Plug / Hot Swap - Live connector insertion / extractions.

IEC - International Electrotechnical Commission, a standard writing organization that prepares and publishes international standards for all electrical, electronic related technologies.

Insulation Resistance - Ratio of applied voltage to the total current between the two electrodes in contact with a specific insulation.

IP - Ingress Protection, a standard per IEC 60529 for measurement of ingress for solids and liquids into an enclosure.

Locator / Positioner - Device for positioning contacts into crimping dies.

Make-First / Break-Last (Premate) - Sequencing of contact(s) so that they engage prior to the main power contacts. Typically used for ground / positive earth / neutral positions as a protective measure against excess currents, short-circuits, and ground faults.

Make-Last / Break-First (Postmate) - Sequencing of contact(s) so that they engage after the main power contacts. Typically used for signal or auxiliary power positions to ensure communications are not started or power circuits switched on until the power contacts are fully engaged.

Mating Force - Force required to join two connector halves in a normal engaging mode.

Modular - Refers to similar parts or modules used as building blocks. A modular connector is one in which similar or identical sections can be assembled together to provide the appropriate connector type or size for the application.

Ohms - Measurement increment of resistance.

Operating Temperature Range - Connector temperature rating established by materials used, plastic, finish, and the base metal. Applying an electrical load will result in a temperature rise that is additive to the operating ambient.

PCB - Acronym for Printed Circuit Board.

Polarization - A technique of eliminating symmetry so that parts may only be mated one way.

Pulse (Surge) Current - Highest instantaneous current that will run.

REACH - The European Community Regulation on chemicals and their safe use. It deals with the Registration, Evaluation, Authorization and Restriction of Chemical substances.

Reducing Bushing - Separate tubular sleeve used to downsize the diameter of a crimp barrel to accept a smaller size wire.

Reeled Contacts - Contacts attached to a feeder strip for use in a high volume crimping tool.

Resistance - The opposition to the passage of an electric current through that element. Abbreviated as "R".

RoHS - Restriction of Hazardous Substances Directive. The European directive on the restriction of the use of certain hazardous substances in electrical and electronic equipment.

Sacrificial Tip - An area of a contact system that absorbs electric arcing to limit damage to the actual mating surface of the contacts.

Self-Wiping - The sliding action which occurs when contacts are mated. Wiping has the effect of removing small amounts of contamination from the contact surfaces, establishing better conductivity.

Spring Loaded - A means of providing contact normal force with the use of a mechanical spring.

Storage Battery - A voltaic battery consisting of two or more storage cells. Energy is accumulated by chemical activity in the charging process and released on demand in the form of electric current.

Strain Relief - A means of termination or installation that reduces the transfer of mechanical stress from the conductor.

Termination - Means of joining contacts to a conductor.

Touch Safe - A connector intended for usage external to the end equipment shall have live parts protected against exposure to contact by persons when assembled, installed, and mated as intended, as determined by UL Articulated Probe.

Turret / Positioner - Device for positioning contacts into crimping dies.

TUV - The TÜV Rheinland Group is provider of technical services that certifies products to standards written by other organizations.

UL - Underwriters Laboratory, a global safety standard writing and testing organization.

Volts - Measurement increment of electric potential. Abbreviated as "E".

VDE - A German standard writing and testing organization responsible standards and safety specifications covering the areas of electrical engineering, electronics, solar power and information technology.

Watt - Measurement increment of electric power. Abbreviated as "W".

Powerpole® Family

Powerpole® Connectors - PP15 to PP180

POWERPOLE® FAMILY



This versatile connector series meets a wide range of power connection needs. There are four basic housing sizes in the Powerpole® product family that allow specific amperage or wire size needs to be filled in the most compact footprint. Powerpole® can handle up to 350 amperes per pole and accommodate wire ranges of 20 to 3/0 AWG (0.75 to 70 mm²). A wide range of colored housing options can be stacked together to create a proven reliable custom connector. These housings can be used with different contacts to create wire-to-wire, wire-to-board, or wire-to-busbar connections. The Powerpole® connector combines high quality materials and a cost effective innovative design to allow powerful versatility.

Stackable Modular Housings

Available in four sizes to right size your connection need

Color Coded Housings

Help ensure that connectors are assembled and mated correctly

Genderless Housings

Provide simplified assembly and minimize the number of components

Low Resistance Connection

Silver or tin plated contacts inside housings that strongly force the contacts together

Self Securing Design

Stainless steel springs create a robust force between the contacts that holds the connector in the mated condition, but allows it to be quickly disconnected

Hot Plugging AC or DC

Contacts feature a sacrificial tip that allow high current circuit interrupt

Connection Versatility

Contacts for wire, PCB, or busbar all fit into the same housings

Powerpole® Family Section

| Powerpole® Size | PP15/45 | Page Number | PP75 | Page Number | PP120 | Page Number | PP180 | Page Number |
|--|--|-------------|--------------------------------------|-------------|----------------------------|-------------|----------------------------|-------------|
| Connector Type | Standard Finger Proof PCB Ground Power Pak | 30 | Standard Locking Busbar PCB | 41 | Standard | 48 | Standard Busbar | 52 |
| Amps (UL) Per Pole | 0 to 55 | | 120 | | 240 | | 350 | |
| Volts (UL) Per Pole | 600 | | 600 | | 600 | | 600 | |
| Wire Gauge - AWG (mm ²) | 20 to 10 (0.75 to 6.0) | | 16 to 6 (1.3 to 13.3) | | 6 to 1/0 (13.3 to 53.5) | | 10 to 3/0 (5.3 to 85.0) | |
| Number of Power Circuits | 1 / Stackable | | 1 / Stackable | | 1 / Stackable | | 1 / Stackable | |
| Ground | • | | | | | | | |
| PCB Mount | • | | • | | | | | |
| Busbar | | | • | | | | • | |
| Panel Mount | • | | • | | • | | • | |
| Blindmate | Powerpole® Pak | | | | | | | |
| Hot Plug | • | | • | | • | | • | |
| Touch Safe | • | | | | | | | |
| Polarized Housing | • | | • | | • | | • | |
| Latching | Powerpole® Pak | | | | | | | |
| Strain Relief | Powerpole® Pak | | | | | | | |

POWERPOLE® FAMILY

Actual Size - Connector Half

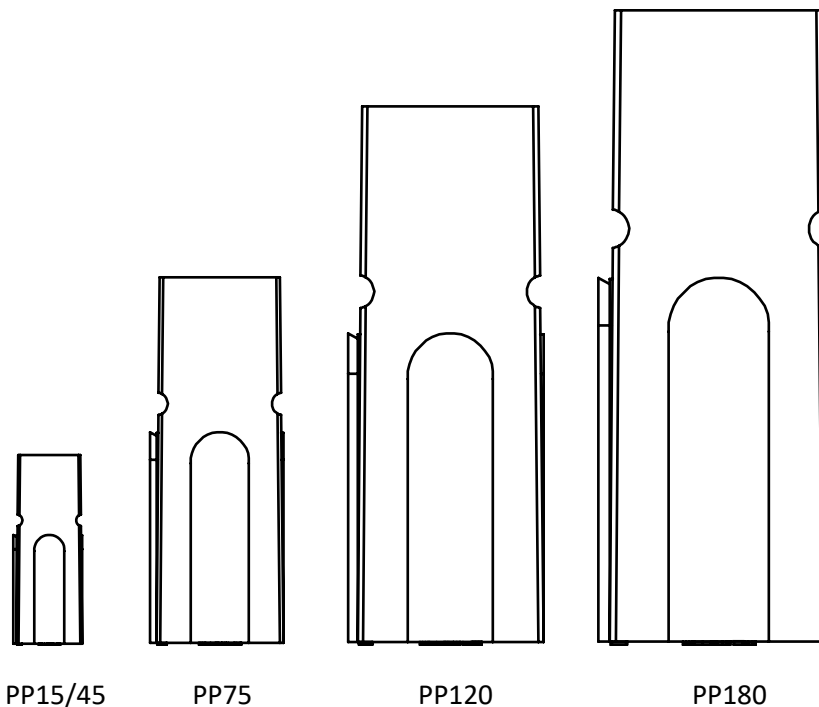

Powerful Versatility

Create Your Own Custom Connector from Durable Proven Components

Powerpole® connectors can be easily customized to each power connection need. Choose from a wide range of colored housings and stack them together into a multiple position connection. Durable silver or tin plated contacts crimp and poke into housings and are available for a broad range of wire sizes. PCB and busbar contacts can also be simply snapped into place using the same housings. Pre-mate ground / power housings and contacts can be used for safety or sequencing and stack along with standard housings.

How to Create Mating Blocks of Stacked Powerpole® Connectors

A Single Row Assembly such as the 1x3 shown below will mate to itself. If an assembly has more than one row such as the Two Row Assembly 2x1 shown below, then a different mirror image mating assembly is required.

Single Row Assembly 1x3



Two Row Assembly 2x1



To Create a Mirror Image Mating Assembly

When mating blocks are viewed with their hoods in the respective orientation (down or up), the column position of connectors is unchanged. The rows themselves are mirror images of each other. So in the below example, what is column 1 on side A, is column 3 on side B.

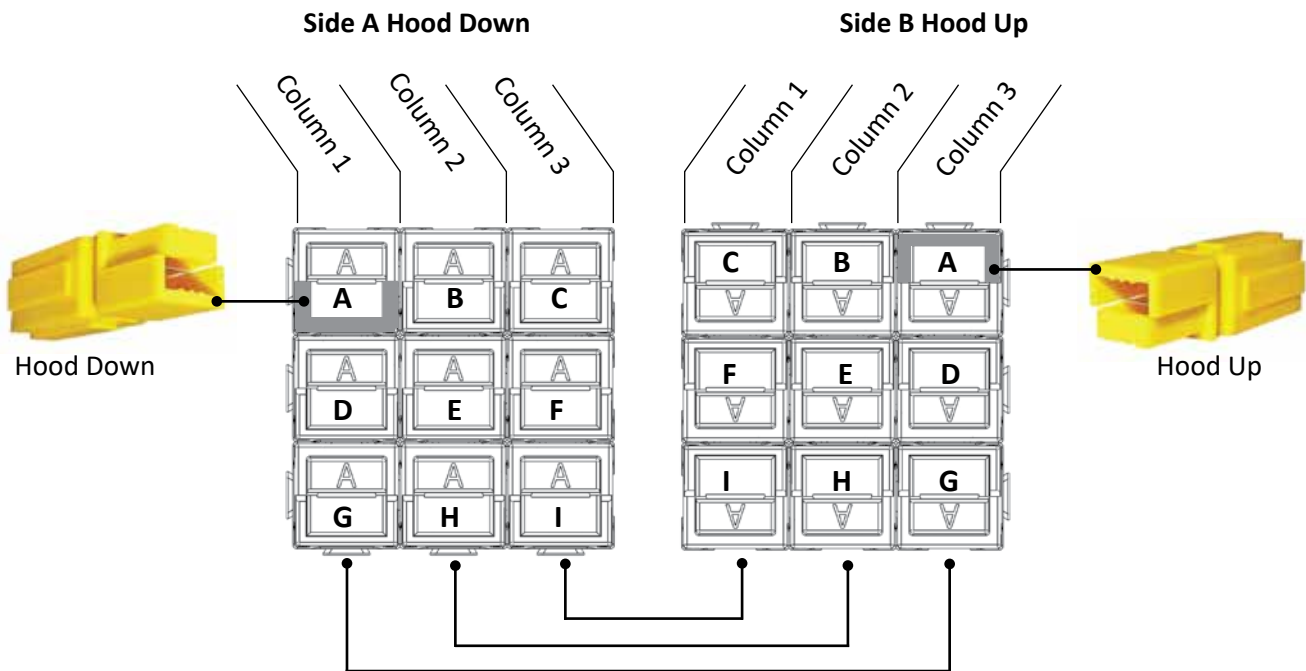

Use the Same Housings for Wire, PCB, or Busbar Connections

The Powerpole® connection system allows the same housings to hold different contacts for terminating to wire, printed circuit boards, or busbars. See some of the many ways Powerpole® components can be assembled to create a custom connection solution.

Wire-to-Wire

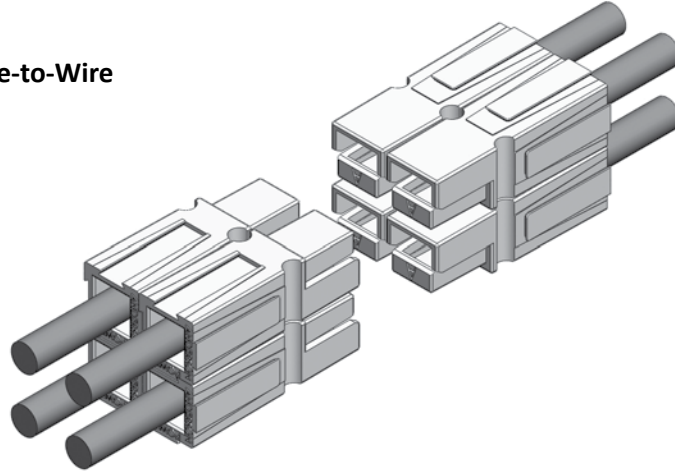

Wire-to-PCB

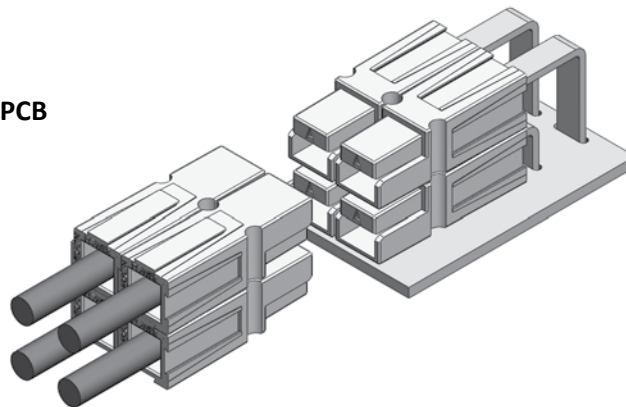

Wire-to-Busbar

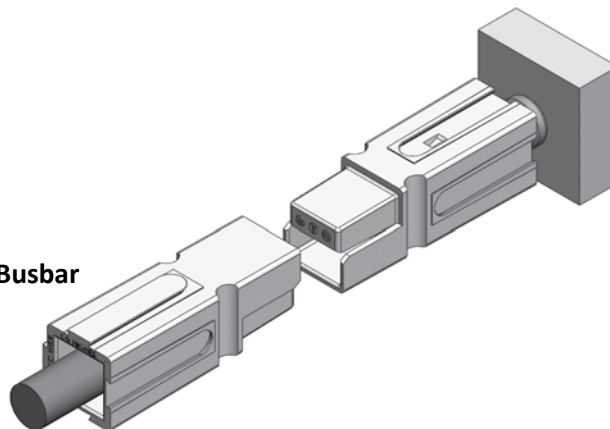

Powerpole® Connectors

PP15/45 - Up to 55 Amps

POWERPOLE® PP15/45

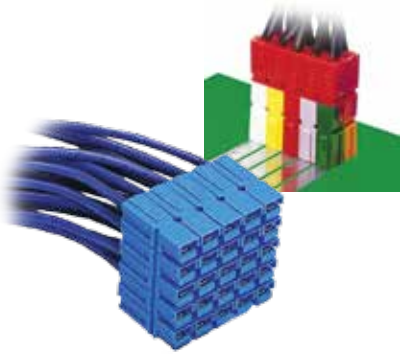

PP15/45 series are the smallest Powerpole® housings. They can be used for wire-to-wire or wire-to-board applications. Wire sizes from 20 to 10 AWG (0.75 to 6 mm²) offer power capabilities up to 55 amps per pole. Finger proof housings and the ability to incorporate first-mate last-break ground connectors enhance the capabilities of this Powerpole® series.

- **High Power Density**
Up to 55 amps in a compact footprint
- **Wire-to-Wire & Wire-to-Board Configurations**
Wire & PCB contacts can be used in the same housings
- **Finger Proof Housings Available**
Protects against accidental contact with live circuits

PP15/45 ORDERING INFORMATION

PP15/45 Finger Proof Housings

Improved on the original APP® design by adding ribs to mating interface to protect against accidental contact with live circuits. Meets the requirements of UL1977 section 10.2 and is rated IP20. Will not mate with standard housings.

| Description | Part Numbers | |
|------------------|--------------|-----------|
| Minimum Quantity | 2,500 | 200 |
| Red | 1327FP-BK | 1327FP |
| Green | 1327G5FP-BK | 1327G5FP |
| Black | 1327G6FP-BK | 1327G6FP |
| White | 1327G7FP-BK | 1327G7FP |
| Blue | 1327G8FP-BK | 1327G8FP |
| Yellow | 1327G16FP-BK | 1327G16FP |

Finger Proof, Standard & Ground Housing Dimensions

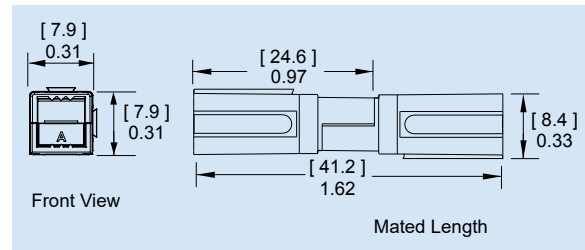

PP15/45 Standard Housings

This original housing design has an open interface and is available in a wide array of colors. Will not mate with finger proof housings.

| Description | Part Numbers | |
|------------------|--------------|---------|
| Minimum Quantity | 2,500 | 200 |
| Red | 1327-BK | 1327 |
| Green | 1327G5-BK | 1327G5 |
| Black | 1327G6-BK | 1327G6 |
| White | 1327G7-BK | 1327G7 |
| Blue | 1327G8-BK | 1327G8 |
| Yellow | 1327G16-BK | 1327G16 |
| Orange | 1327G17-BK | 1327G17 |
| Gray | 1327G18-BK | 1327G18 |
| Brown | 1327G21-BK | 1327G21 |
| Pink | 1327G22-BK | 1327G22 |
| Purple | 1327G23-BK | 1327G23 |

Finger Proof Rib Feature

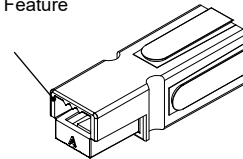

Standard Housing

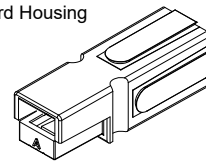

45A Premate Ground Housings - for use with ground contacts only

Will mate with standard Powerpole® housings.

| Description | Part Numbers | |
|------------------|--------------|--------|
| Minimum Quantity | 2,500 | 200 |
| Green | 1827G1-BK | 1827G1 |

Premate Ground Open Front

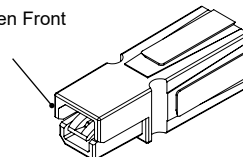

PP15/45 Tin Plated Power Contacts

Offer cost effective performance up to 1,500 mating cycles. See specifications and temperature charts for amperage ratings by wire size.

| Barrel | AWG | mm ² | Mating Force | Loose Piece Part Numbers | Reeled Part Numbers | Dimensions - A - | |
|------------------|---------------|-----------------|--------------|--------------------------|---------------------|------------------|------|
| | | | | | | inches | mm |
| Minimum Quantity | | | | 200 | 5,000 | | |
| Open | 14 to 10 K * | 2.1 to 5.3 | High | 269G3-LPBK | 269G3 | 0.21 | 5.33 |
| Open | 14 to 10 K * | 2.1 to 5.3 | Low | 261G2-LPBK | 261G2 | 0.20 | 5.08 |
| Open | 14 to 10 SF * | 2.1 to 6.0 | High | 201G1H-LPBK | 201G1H | 0.24 | 6.10 |
| Open | 14 to 10 SF * | 2.1 to 6.0 | Low | 200G1L-LPBK | 200G1L | 0.24 | 6.10 |
| Open | 16 to 12 | 1.3 to 3.3 | High | 269G1-LPBK | 269G1 | 0.18 | 4.57 |
| Open | 16 to 12 | 1.3 to 3.3 | Low | 261G1-LPBK | 261G1 | 0.18 | 4.57 |
| Open | 20 to 16 | 0.52 to 1.3 | High | 269G2-LPBK | 269G2 | 0.16 | 4.06 |
| Open | 20 to 16 | 0.52 to 1.3 | Low | 262G1-LPBK | 262G1 | 0.16 | 4.06 |

K * - For #10 AWG class K stranded wire or smaller. For larger wires use superflex contacts.

SF*- Indicates wires with high stranding such as Super Flex.

Open Barrel Contact

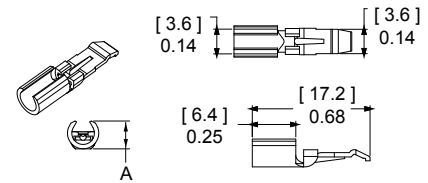

PP15/45 Silver Plated Power Contacts

Maximize performance by offering up to 10,000 mating cycles and are recommended for circuit interrupt or hot plug applications. See specifications and temperature charts for amperage ratings by wire size. Only closed barrel contacts are suitable for soldering.

| Barrel | AWG | mm ² | Mating Force | Loose Piece Part Numbers | Reeled Part Numbers | Dimensions | | | | |
|------------------|---------------|-----------------|--------------|--------------------------|---------------------|------------|------|-------|------|------|
| | | | | | | - A - | | - B - | | |
| | | | | inches | mm | inches | mm | | | |
| Minimum Quantity | | | | 5,000 | 200 | 5,000 | | | | |
| Open | 14 to 10 K * | 2.1 to 5.3 | Low | - | 261G3-LPBK | 261G3 | 0.20 | 5.08 | - | - |
| Open | 14 to 10 SF * | 2.1 to 6.0 | Low | - | 200G3L-LPBK | 200G3L | 0.24 | 6.10 | - | - |
| Open | 20 to 16 | 0.52 to 1.3 | Low | - | 262G2-LPBK | 262G2 | 0.16 | 4.06 | - | - |
| Closed | 16 to 12 | 1.3 to 3.3 | Low | 1331-BK | 1331 | - | 0.15 | 3.81 | 0.10 | 2.54 |
| Closed | 20 to 16 | 0.52 to 1.3 | Low | 1332-BK | 1332 | - | 0.12 | 3.05 | 0.07 | 1.78 |

K * - For #10 AWG class K stranded wire or smaller. For larger wires use superflex contacts.

SF*- Indicates wires with high stranding such as Super Flex.

Open Barrel Contact

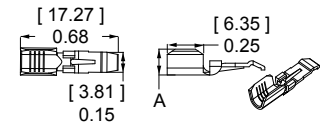

Closed Barrel Contact

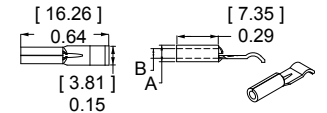

45A Premate Ground Wire Contacts - for use with ground housing only

Tin or silver plated contacts are rated for ground or power. Hand tools are available for loose piece contacts. Reeled contacts can be used with high volume press and applicator tooling. Tin contacts are rated for up to 1,500 mating cycles. Silver contacts are rated up to 10,000 mating cycles.

| Type | AWG | mm ² | Mating Force | Loose Piece Part Numbers | Reeled Part Numbers |
|------------------|----------|-----------------|--------------|--------------------------|---------------------|
| Minimum Quantity | | | | 200 | 2,500 |
| Open, Tin | 14 to 10 | 2.1 to 6.0 | Low | 1830G1-LPBK | 1830G1 |
| Open, Silver | 14 to 10 | 2.1 to 6.0 | Low | 1830G2-LPBK | 1830G2 |

Open Barrel Premate Contact

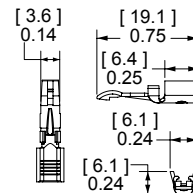

25A Right Angle PCB Contacts Tin Plated

Suitable for right angle applications up to 25A per pole. Tin plating enhances solderability. Cannot be mixed with 45A PCB contacts. For mating with wire contacts only.

| Row | Mating Force | Loose Piece Part Numbers | Dimensions | | | | |
|------------------|--------------|--------------------------|------------|--------|-------|------|-------|
| | | | - A - | | - B - | | |
| | | inches | mm | inches | mm | | |
| Minimum Quantity | | 1,000 | 100 | | | | |
| Top | Low | 1377G1-BK | 1377G1 | 0.58 | 14.80 | 1.52 | 38.60 |
| | High | 1317G1-BK | 1317G1 | | | | |
| Bottom | Low | 1377G2-BK | 1377G2 | 0.29 | 7.20 | 1.36 | 34.50 |
| | High | 1317G2-BK | 1317G2 | | | | |
| Top | Low | 1377G11-BK | 1377G11 | 0.58 | 14.80 | 1.21 | 30.70 |
| | High | 1317G11-BK | 1317G11 | | | | |
| Bottom | Low | 1377G12-BK | 1377G12 | 0.29 | 7.20 | 1.01 | 25.70 |
| | High | 1317G12-BK | 1317G12 | | | | |

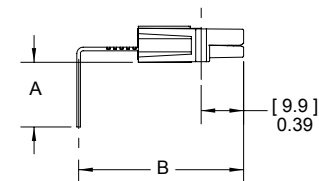
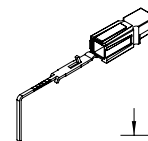

- Use mounting staples with right angle contacts (see accessories).
- See website for PCB layout drawing.

25A Vertical PCB Contacts Tin Plated

For mating with wire contacts only. Suitable for vertical applications up to 25A per pole, tin plating enhances solderability.

| Mating Force | Loose Piece Part Numbers | Dimensions - A - |
|------------------|--------------------------|------------------|
| | | inches mm |
| Minimum Quantity | | |
| Low | 1377G3-BK 1377G3 | 2.22 56.40 |
| High | 1317G3-BK 1317G3 | 2.22 56.40 |
| Low | 1377G4-BK 1377G4 | 1.76 44.70 |
| High | 1317G4-BK 1317G4 | 1.76 44.70 |
| Low | 1377G13-BK 1377G13 | 1.17 29.70 |
| High | 1317G13-BK 1317G13 | 1.17 29.70 |

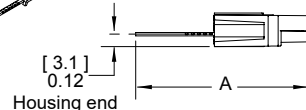
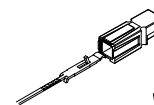

45A Right Angle and Vertical PCB Contacts Tin Plated

Suitable for right angle or vertical applications up to 45A per pole. Tin plating enhances solderability. Right angle contacts cannot be mixed with 25A PCB contacts. For mating with wire contacts only.

| Description | Loose Piece Part Numbers | |
|------------------------|--------------------------|--------|
| | Minimum Quantity | 1,000 |
| Vertical | 3-5911P1 | 1335G1 |
| Right Angle Bottom Row | 3-5912P1 | 1336G1 |
| Right Angle Top Row | 3-5913P1 | 1337G1 |

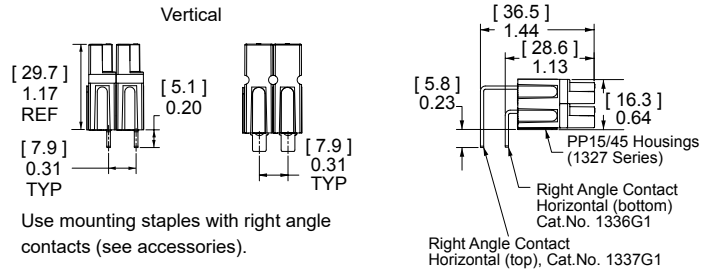

Use mounting staples with right angle contacts (see accessories).

45A Premate Ground PCB Contacts

Right angle contacts are suitable for power or ground. Use to mate with 45A ground wire contacts. Tin plated contacts are rated up to 1,500 mating cycles. Can be used with other 45A PCB connectors in the bottom row.

| | Mating Force | Loose Piece Part Numbers | |
|-----------------|--------------|--------------------------|--------|
| | | Minimum Quantity | 1000 |
| PCB, Bottom Row | Low | 3-5952P1 | 1836G1 |

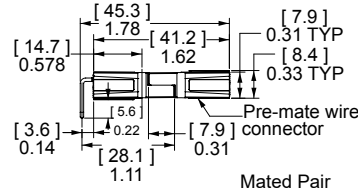

PP15/45 ULTRASONICALLY BONDED ASSEMBLIES

Assemblies feature housings that are ultrasonically welded to create a one piece connector unit using an APP® special process. After welding, retaining pins are no longer required to secure the stacked housings to each other. This allows Powerpole® 15/45 connectors to be used as a durable one piece connector header. Contact customer service for configurations not shown below.

Single Row 1x2 Assemblies

| Circuit Description | Housings Only | Housings with 45A Vertical PCB Contacts | Housings with 45A Right Angle PCB Contacts | Color & Type Position Matrix | |
|-------------------------------------|----------------|---|--|------------------------------|-----------|
| | | | | 1 | 2 |
| Minimum Quantity | 500 | 500 | 500 | 1 | 2 |
| DC 2 Wire Standard Housings | ASMPP30-1X2-RK | ASMPV45-1X2-RK | ASMPR45-1X2-RK | RED / STD | BLK / STD |
| DC 2 Wire Reverse Standard Housings | ASMPP30-1X2-KR | ASMPV45-1X2-KR | ASMPR45-1X2-KR | BLK / STD | RED / STD |
| DC 2 Wire Finger Proof | ASMFP30-1X2-RK | ASMPV45-1X2-RK | ASMPR45-1X2-RK | RED / FP | BLK / FP |
| DC 2 Wire Finger Proof Reverse | ASMFP30-1X2-KR | ASMPV45-1X2-KR | ASMPR45-1X2-KR | BLK / FP | RED / FP |

Single Row 1x3 Assemblies

| Circuit Description | Housings Only | Housings with 45A Right Angle PCB Contacts | Color & Type Position Matrix | | |
|------------------------------------|-----------------|--|------------------------------|-----------|----------|
| | | | 1 | 2 | 3 |
| Minimum Quantity | 500 | 500 | 1 | 2 | 3 |
| DC 2 Wire Finger Proof with Ground | ASMFP30-1X3-KER | ASMPFR45-1X3-KER | BLK / FP | GRN / GND | RED / FP |
| AC Single Phase Finger Proof | ASMFP30-1X3-KEW | ASMPFR45-1X3-KEW | BLK / FP | GRN / GND | WHT / FP |

Two Row 2x1 Assemblies

| Circuit Description | Housings Only | Housings with 45A Vertical PCB Contacts | Housings with 45A Right Angle PCB Contacts | Color & Type Position Matrix | |
|-----------------------------|----------------|---|--|------------------------------|----------|
| | | | | 1 | 2 |
| Minimum Quantity | 500 | 500 | 500 | 1 | 2 |
| DC 2 Wire Finger Proof | ASMFP30-2X1-KR | ASMPV45-2X1-KR | ASMPR45-2X1-KR | BLK / FP | RED / FP |
| DC 2 Wire Finger Proof Mate | ASMFP30-2X1-RK | ASMPV45-2X1-RK | ASMPR45-2X1-RK | RED / FP | BLK / FP |

Two Row 2x2 Assemblies

| Circuit Description | Housings Only | Housings with 45A Vertical PCB Contacts | Housings with 45A Right Angle PCB Contacts | Color & Type Position Matrix | | | |
|--------------------------------------|------------------|---|--|------------------------------|-----------|----------|-----------|
| | | | | 1 | 2 | 3 | 4 |
| Minimum Quantity | 500 | 500 | 500 | 1 | 2 | 3 | 4 |
| AC 3 Phase, 3 Wire Finger Proof | ASMFP30-2X2-KRWE | N/A | N/A | BLK / FP | RED / FP | WHT / FP | GRN / GND |
| AC 3 Phase, 3 Wire Finger Proof Mate | ASMFP30-2X2-WEKR | N/A | ASMPFR45-2X2-WEKR | WHT / FP | GRN / GND | BLK / FP | RED / FP |



Single Row 1x2 Assembly



Single Row 1x3 Assembly



Two Row 2x1 Assembly

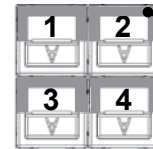

Two Row 2x2 Assembly

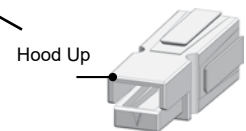

Type

STD = Standard Housing FP = Finger Proof Housing GND = Ground Housing

Powerpole® Pak Connectors

PP15/45



Powerpole® Pak connector shells enclose stacked groupings of PP15/45 sized housings in a durable black shell for a finished connector appearance and additional features. Inline, panel mount, and blindmate configurations are available. Plug shells offer the option of integral latches and strain relief to help secure your connection.

- Package Groupings of PP15/45 Connectors**
Provides a finished appearance while protecting the individual connectors with an outer shell
- Inline, Panel Mount, "T" or Blindmate Configurations**
Allows one connection system to meet multiple needs
- Optional Latching and Strain Relief**
Secures your connection and wires

POWERPOLE® PAK

For environmentally sealed connector shells to hold Powerpole® 15 to 180 connectors, see SPEC Pak® product series on our website www.andersonpower.com



POWERPOLE® PAK ORDERING INFORMATION - Powerpole® housings and contacts are sold separately

Plug Shell Without Latch

Can mate inline with other plug shells with or without latches, or mate to a panel mount receptacle. For use with Powerpole® wire connectors only. Cable Clamp and Hardware Pak or Retaining Pins must be ordered separately.

| Description | Part Numbers | | | Dimensions - A - | |
|---------------------|--------------|-----------|--------|---------------------|-------|
| | 1,000 | 500 | 25 | inches | mm |
| Black, 2 to 4 Poles | 1461G1-BK | - | 1461G1 | 1.24 | 31.50 |
| Black, 5 to 6 Poles | - | 1461G2-BK | 1461G2 | 1.56 | 39.62 |
| Black, 7 to 8 Poles | - | 1461G3-BK | 1461G3 | 1.87 | 47.50 |

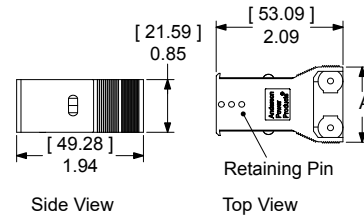

NOTE: Retaining pins are used to secure and position Powerpole® housings in one of three positions in plug shells.

Max wire O.D. for 2 to 4 pole plug shells is 0.60 inches (15.2 mm²).
For all other plug shells is 0.63 inches (16.0 mm²).

Plug Shell With Latch

Can mate inline with other plug shells without latches, or mate to a panel mount receptacle. For use with Powerpole® wire connectors only. Cable Clamp and Hardware Pak or Retaining Pins must be ordered separately.

| Description | Part Numbers | | | Dimensions | | | | | |
|----------------------|--------------|-----------|--------|------------|-------|--------|-------|--------|-------|
| | 1,000 | 500 | 25 | - B - | | - C - | | - D - | |
| | | | | inches | mm | inches | mm | inches | mm |
| Black, 2 to 4 Poles | 1460G1-BK | - | 1460G1 | 1.94 | 49.28 | 2.25 | 57.15 | 1.24 | 31.50 |
| Black, 5 to 6 Poles | - | 1460G2-BK | 1460G2 | 1.94 | 49.28 | 2.25 | 57.15 | 1.56 | 39.62 |
| Black, 7 to 8 Poles | - | 1460G3-BK | 1460G3 | 1.94 | 49.28 | 2.25 | 57.15 | 1.87 | 47.50 |
| Black, 9 to 10 Poles | - | 1460G4-BK | 1460G4 | 2.51 | 63.75 | 2.82 | 71.63 | 1.84 | 46.74 |

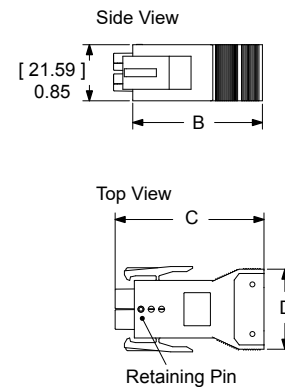

Plug Shell With Latch & Non-Conductive Strain Relief

New 2X3 Powerpole® Pak offers an improved ergonomic shell for easier latch operation as well as a plastic, non-conductive strain relief. The new strain relief can accommodate up to a 6 conductor 10 AWG cable. Can mate to a panel mount receptacle. For use with Powerpole® wire connectors only. Cable Clamp and Hardware Pak or Retaining Pins must be ordered separately. To be used with 115G23 cable clamp only.

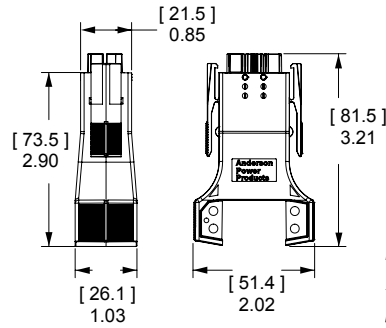

NOTE: Max wire O.D. for 1460G23 is 0.80 inches [20.3 mm²].

| Description | Part Numbers | |
|---------------------|--------------|---------|
| Minimum Quantity | 1,000 | 25 |
| Black, 5 to 6 Poles | 1460G23-BK | 1460G23 |

Snap-in Receptacle Shell

Mate to plug shells with or without latches, or mate to another panel mount receptacle to create a bulkhead to bulkhead connection. For use with Powerpole® wire or PCB connectors. Order the number of retaining pins for each receptacle as shown below separately.

| Description | Part Numbers | | Number of Retaining to Order | Dimensions | | Knock Out Size | | |
|----------------------|--------------|-----------|------------------------------|--------------|------|------------------|------|-------|
| | | | | - E - inches | mm | - Width - inches | mm | |
| Minimum Quantity | 1,000 | 500 | 25 | | | | | |
| Black, 2 to 4 Poles | 1470G1-BK | - | 1470G1 | 1 | 1.50 | 38.10 | 1.25 | 31.75 |
| Black, 5 to 6 Poles | - | 1470G2-BK | 1470G2 | 2 | 1.88 | 47.75 | 1.62 | 41.15 |
| Black, 7 to 8 Poles | - | 1470G3-BK | 1470G3 | 3 | 2.13 | 54.10 | 1.88 | 47.75 |
| Black, 9 to 10 Poles | - | 1470G4-BK | 1470G4 | 4 | 2.44 | 61.98 | 2.19 | 55.63 |

* Height = (25.4 mm) 1.0 in.

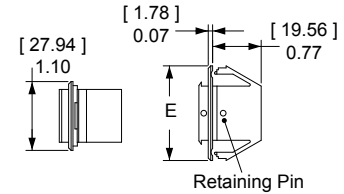

NOTE: Retaining pins are used to secure and position Powerpole® housings in one of two positions in receptacle shells.

Cable Clamp & Hardware Pak

Includes cable clamp, 2 screws, and required amount of retaining pins for each configuration.

| Description | Screw Head Type | Cable Type | Part Numbers | | |
|------------------|-----------------|------------|--------------|----------|-------|
| Minimum Quantity | | | 1,000 | 500 | 25 |
| 2 to 4 Poles | Straight Slot | Bundled | 115G1-BK | - | 115G1 |
| 5 to 6 Poles | Straight Slot | Bundled | 115G2-BK | - | 115G2 |
| 7 to 8 Poles | Straight Slot | Bundled | 115G3-BK | - | 115G3 |
| 9 to 10 Poles | Straight Slot | Bundled | - | 115G4-BK | 115G4 |
| 2 to 4 Poles | Phillips | Bundled | 115G7-BK | - | 115G7 |
| 5 to 6 Poles | Phillips | Bundled | 115G8-BK | - | 115G8 |

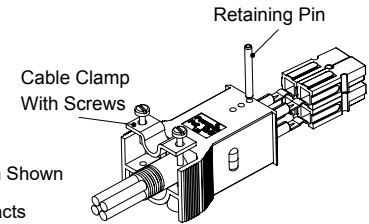

Plug Shell Without Latch Shown
Shell, housing and contacts are sold separately.

Cable Clamp & Hardware Pak

Includes 2 cable clamp halves, 2 screws and 2 retaining pins. To be used with 1460G23 Plug Shell only.

| Description | Screw Head Type | Cable Type | Part Numbers | |
|------------------|-----------------|------------|--------------|--------|
| Minimum Quantity | | | 1,000 | 25 |
| 5 to 6 Poles | Phillips | Bundled | 115G23-BK | 115G23 |

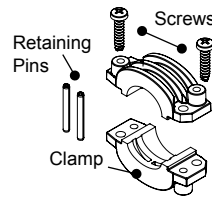

Flexible Conduit Clamp & Hardware Pak

Includes cable clamp, 2 screws, and need amount of retaining pins for each configuration.

| Description | Part Number |
|------------------|-------------|
| Minimum Quantity | 100 |
| 2 to 4 Poles | 110G10 |

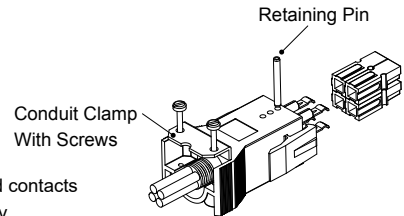

Shell, housing and contacts are sold separately.

Plug Shell With Latch Shown

Retaining Pin for Snap-in Receptacle

Order the number of retaining pins for each receptacle shown in the Snap-in Receptacle Shell ordering information. Pins are also required for the plug side when the Cable Clamp & Hardware Pak is not ordered.

| Description | Part Numbers | |
|------------------|--------------|-------|
| Minimum Quantity | 1,000 | 100 |
| Retaining Pin | 110G9-BK | 110G9 |

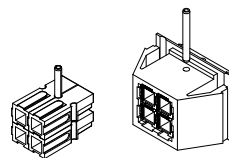

Shell and housing are sold separately.

Blindmate Pak Connector

Ideal for panel to panel, bulkhead to bulkhead, or rack mount applications that require the power connector to compensate for up to 0.45 in. (11.43 mm) of misalignment in either axis. Eight positions can be filled with Powerpole® 10 to 45 connectors. The receptacle side can be used with wire or PCB contacts. Hardware bag includes retaining pins.

| Description | Part Numbers | |
|---|--------------|------------|
| Minimum Quantity | 50 | 25 |
| 2x4 Blindmate Plug Shell, Hardware & Pins | - | BMPP10-45P |
| 2x4 Blindmate Receptacle Shell, Hardware & Pins | - | BMPP10-45R |
| 2x4 Blindmate Plug Shell | BMHSG-P | - |
| 2x4 Blindmate Receptacle Shell | BMHSG-R | - |
| Hardware Bag Plug Side | - | 110G50 |
| Hardware Bag Receptacle Side | - | 110G51 |

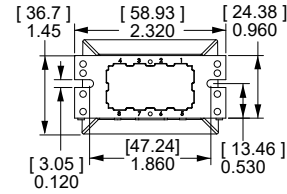
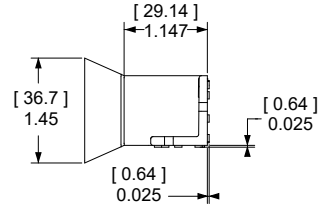
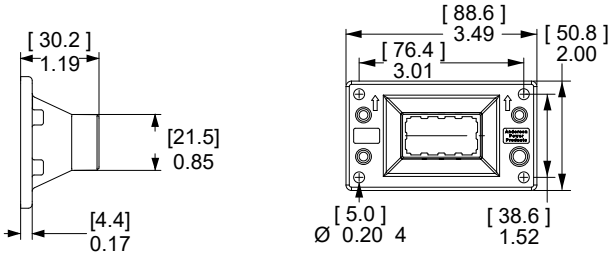

See our innovative MARC Connector that offers straight-on or rotational blindmate capability. MARC holds 6 PP15/45 power contacts and 2 PP15/45 premate ground contacts in a high temperature housing. Visit our website www.andersonpower.com to learn more.



“T” Pak 2 Way Splitter

The Powerpole® “T” Pak connector is a 2 way electrical splitter that splits electrical current from one incoming circuit into two outgoing circuits. The standard configuration is pre-wired for AC 3 phase, 3 wire plus ground configurations. The “T” Pak can also be used for AC single phase plus ground or DC 2 wire plus ground applications by not using either the red or white power positions. “T” Pak is pre-wired from the factory allowing plug and play field installation of modular office and industrial equipment. UL recognition up to 20 amps and 600 volts is achieved when mating Powerpole® Pak plugs with 12 AWG wire.

For OEM manufacturing scale applications, the “T” Pak can be loaded with custom configurations of any of our finger proof, standard, or ground housings and contacts in the PP15/45 series. Contact sales or customer service for additional information.

| Description | Part Numbers |
|-------------------------------------|--------------|
| Minimum Quantity | 80 |
| Assembled “T” Pak | 20-01 |
| Mating Plug Shell with Latch 2x2 | 26-01 |
| Mating Plug Shell without Latch 2x2 | 27-01 |

Standard configuration for each side of the T includes (1) each Red, Black, and White Standard PP15/45 Housings & 261G2-LPBK contacts with (1) 45A Green Premate Ground Housing and 1830G1-LPBK contact.

Mating plug shells include (1) each Red, Black, and White Standard PP15/45 Housings & (3) 261G2-LPBK contacts with (1) 45A Green Premate Ground Housing and 1830G1-LPBK contact. Cable clamp & hardware pack also included.

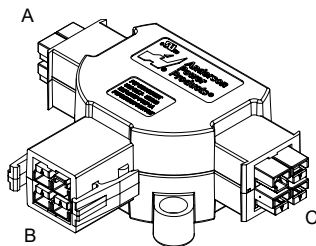
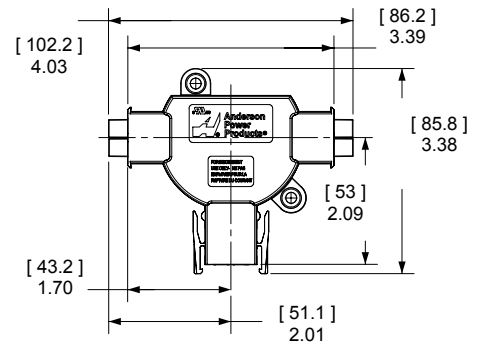

27 - 01
Mates With B



26 - 01
Mates With A & C

PP15/45 CONNECTOR TEMPERATURE CHARTS - Temperature rise charts are based on a 25°C ambient temperature.

Current - Temperature Derating per IEC 60512-5-2 Test 5B

POWERPOLE® PP15/45

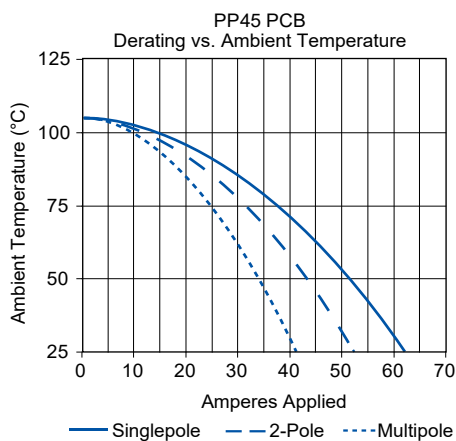
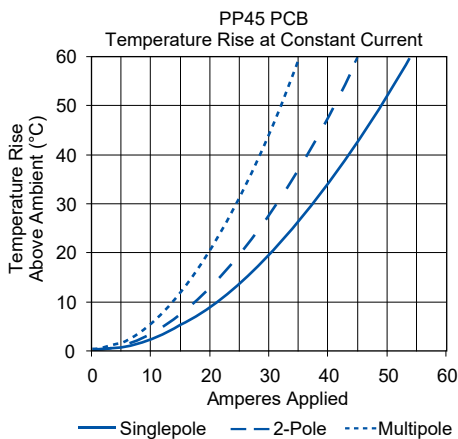
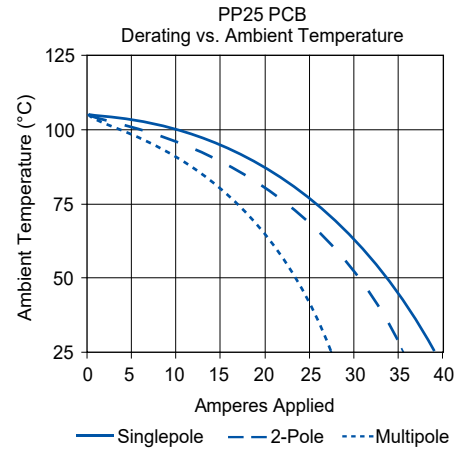
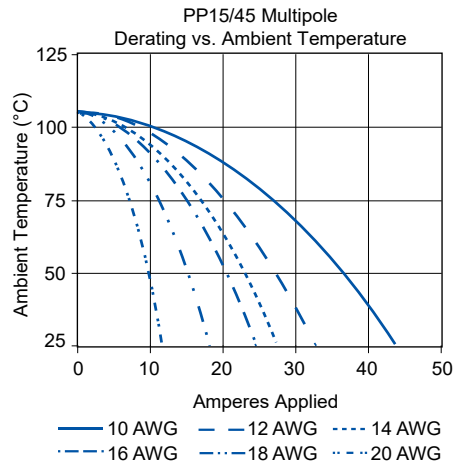
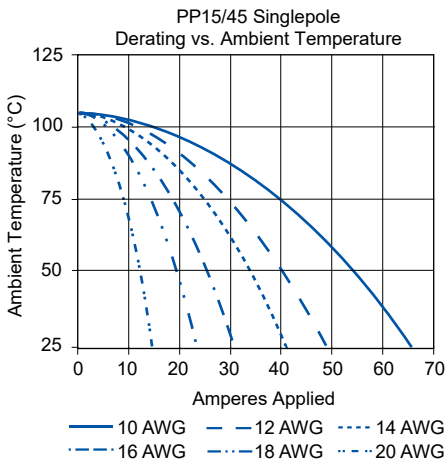
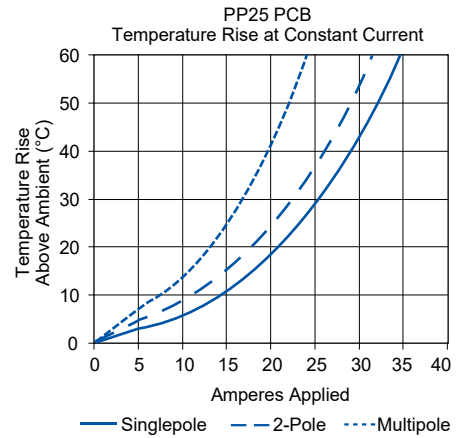
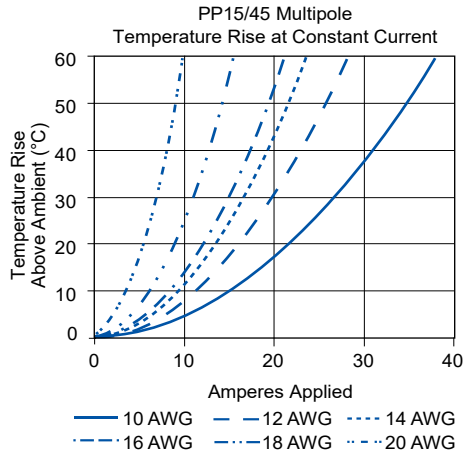
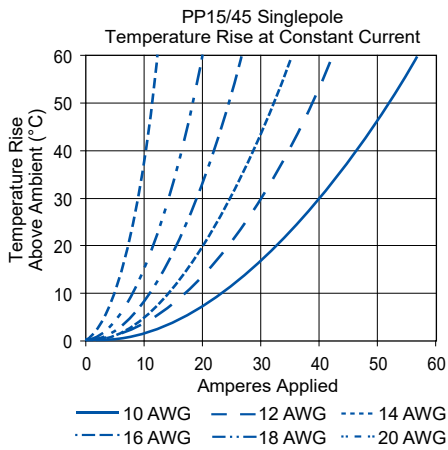

NOTE: PP25 PCB charts based on 0.002 in² foil on board side, mated to 12 AWG conductor on wire side. PP45 PCB charts based on 10 AWG equivalent copper foil on board side, mated to 10 AWG conductor on wire side.

PP15/45 & POWERPOLE® PAK SPECIFICATIONS

POWERPOLE® PP15/45

| ELECTRICAL | | |
|---|----------------|------------------|
| Current Rating Amperes ¹ | UL 1977 | CSA / TUV |
| Singlepole Wire-to-Wire (10 AWG) | 55 | 40 |
| Singlepole Ground Wire-to-Wire or PCB (10 AWG) | 45 | 35 |
| 3x3 Block Wire-to-Wire (10 AWG) | 40 | 27 |
| Singlepole 25A PCB-to-Wire (12 AWG) | 25 | - |
| 2x3 Block 25A PCB-to-Wire (12 AWG) | 25 | 22 * |
| Singlepole 45A PCB-to-Wire (10 AWG) | 45 | 40 * |
| 2x3 Block 45A PCB-to-Wire (10 AWG) | 45 | 25 * |
| Voltage Rating AC/DC | | |
| UL 1977 | 600 | |
| Dielectric Withstanding Voltage | | |
| Volts AC | 2,200 | |
| Avg. Mated Contact Resistance Milliohms ¹ | | |
| 15A Wire Contact with 5/8" of 16 AWG | 0.875 | |
| 30A Wire Contact with 5/8" of 12 AWG | 0.600 | |
| 45A Wire Contact with 5/8" of 10 AWG | 0.525 | |
| 45A PCB Contact to Contact | 0.500 | |
| 25A PCB Contact to Contact | 0.600 | |
| UL Hot Plug Current Rating Amperes ⁵ | | |
| 250 Cycles at 72V DC | 45A | |
| 250 Cycles at 120V DC | 30A | |
| UL Ground Short Time Current Test - 45A Premate Ground | | |
| 750 Amps, 10 AWG Wire | 4 Seconds | |
| 470 Amps, 12 AWG Wire | 4 Seconds | |

| MATERIAL | |
|------------------------------------|----------------------------|
| Housing | |
| Plastic Resin | Polycarbonate |
| Contact Retention Spring | Stainless Steel |
| Housing Flammability Rating | |
| UL94 | V-0 |
| Glow Wire | 825°C (GWF) / 800°C (GWIT) |
| Contact | |
| Base | Copper Alloy |
| Plating | Tin or Silver |
| Contact Termination Methods | |
| Crimp ³ | Wire Contacts |
| Hand Solder | 1331, 1332 & PCB Contacts |
| Solder Dip | PCB Contacts |
| Wave Solder | PCB Contacts |

| MECHANICAL | | |
|---|----------------------|-----------------------|
| Wire Size Range | AWG | mm² |
| | 20 to 10 | 0.75 to 6.0 |
| Max. Wire Insulation Diameter | in. | mm |
| | 0.175 | 4.450 |
| Operating Temperature ² | °F | °C |
| Powerpole® Housings & Powerpole® Pak Shells | -4° to 221° | -20° to 105° |
| Mating Cycles No Load by Plating | Silver (Ag) | Tin (Sn) |
| PCB-to-Wire | - | 1,500 |
| Wire-to-Wire | 10,000 | 1,500 |
| Avg. Mating / Unmating Force | Lbf. | N |
| Low Force Wire, High Force PCB, & Ground | 3 | 13 |
| High Force Wire | 5 | 22 |
| Low Force PCB | 2 | 9 |
| Min. Contact / Spring Retention Force | Lbf. | N |
| | 20 | 90 |
| Powerpole® Pak Latch Avg. Defeat Force | Lbf. | N |
| | 150 | 667 |
| PCB Specifications | | |
| Mounting Style | Plated Through Hole | |
| PCB Thickness - in. (mm) | 0.090 to 0.150 | 2.3 to 3.8 |
| 25A PCB Recommended Traces | 12 AWG Cross Section | |
| 45A PCB Recommended Traces | 10 AWG Cross Section | |
| Mechanical Shock ⁴ | | |
| MIL-STD-202 | 213 Condition A | 50g's |
| Vibration High Frequency ⁴ | | |
| MIL-STD-202 | 204 Condition A | 10g's |

NOTE 1: See IEC 60664-1 for working voltage.

NOTE 2: Amp ratings are stated per position and based on all positions being fully loaded.

* No TUV Recognition

1 - Based on: 105°C rated or better cable of the largest size, Properly calibrated APP® recommended tooling, and a 25°C ambient temperature. UL rating not to exceed the maximum operating temperature. CSA rating below a 30°C temperature rise.

2 - Limited by the thermal properties of the connector plastic housing.

3 - Use APP® recommended tooling only. Alternate tools may adversely affect the performance of our connectors along with UL and CSA recognition.

4 - Tested with contact part number 261G2.

5 - Based on 2 housings blocked together.



IEC INFORMATION

POWERPOLE® PP15/45

| Connector Series | Configurations | Creepage / Clearance per IEC 60950-1 | Material Group |
|------------------|--------------------|--------------------------------------|----------------|
| PP15/45 Standard | Single Pole | Unmated | 1.64 mm |
| | | Mated | 1.64 mm |
| | Stacked Powerpole® | Unmated | 1.64 mm |
| | | Mated | 1.64 mm |
| | PCB - 25A | Unmated | 1.64 mm |
| | | Mated | 1.64 mm |
| | PCB - 45A | Unmated | 1.39 mm |
| | | Mated | 1.39 mm |
| | | | IIIa |

| Connector Series | Configurations | Creepage / Clearance per IEC 60950-1 | Material Group |
|----------------------|--------------------|--------------------------------------|----------------|
| PP15/45 Finger Proof | Single Pole | Unmated | 1.64 mm |
| | | Mated | 4.20 mm |
| | Stacked Powerpole® | Unmated | 1.64 mm |
| | | Mated | 4.20 mm |
| | PCB - 25A | Unmated | 1.64 mm |
| | | Mated | 2.90 mm |
| | PCB - 45A | Unmated | 1.39 mm |
| | | Mated | 1.39 mm |
| | | | IIIa |

| ATTRIBUTES | PP45 | PP45 FINGER PROOF |
|---|---|---|
| AMP Rating AC/DC | 45 | 45 |
| Voltage Rating AC/DC (Steady State) | 160 V AC/DC (Operational) | 400 V AC/DC (Operational) |
| Breaking Capacity - AMP Rating / Cycles | 30 Amp / 10 Cycles | 30 Amp / 10 Cycles |
| Voltage Rating (Breaking Capacity) | 220 VDC | 220 VDC |
| FINGER Safety - Mated Only | IEC 60529 - IP20 | IEC 60529 - IP20 * |
| Wire Size Tested | 6 mm ² | 6 mm ² (10AWG) |
| Contact Series Tested | 200G3L | 200G3L |
| Climatic Testing (Cold, Heat & MFG) | IEC 60512 Test - 11j, 11i & 11g | IEC 60512 Test-11j, 11i & 11g |
| Cycle Life | IEC 60512 Test 9a - 5,000 Cycles | IEC 60512 Test 9a - 5,000 Cycles |
| Mechanical Strength Impact | IEC 60512-5 @ 29.5 Inches - Dropped 8 Times | IEC 60512-5 @ 29.5 Inches - Dropped 8 Times |
| Temperature Range | -20°C to 105°C -4°F to 221°F | -20°C to 105°C -4°F to 221°F |

* Mated and unmated for the PP15/45 FP version only

PROTECTION

Touch Safety with Finger Proof Housings & Wire Contacts or PCB Mating Interface

| | |
|------------------|------|
| UL1977 Sec. 10.2 | Pass |
| IEC 60950 | Pass |
| IEC 60529 | IP20 |

Touch Safety With Standard Housings

| | |
|-----------|------|
| IEC 60529 | IP10 |
|-----------|------|



POWERPOLE® 15/45 ACCESSORIES

Mounting Wing

Secure dovetailed Powerpole® 15/45 series housings by passing fasteners through the wings in either a horizontal or vertical orientation. Useful for sheet metal panels, printed circuit boards, and many other mounting surfaces. Fasteners not included.

| Description | Part Numbers | |
|------------------|--------------|--------|
| Minimum Quantity | 2,500 | 100 |
| Red | 1399G9-BK | 1399G9 |
| Blue | 1399G8-BK | 1399G8 |

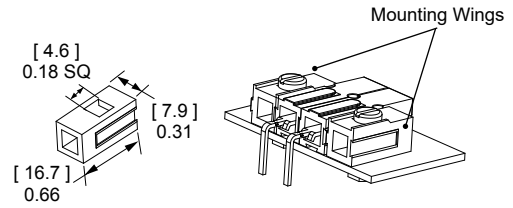

Spacer

Used to separate housings under high power to minimize derating. They are recommended for squaring off a block of Powerpole® 15/45 housings for use in connector shells and mounting clamps. Use a combination of long and short spacers opposite each other in a mated block to add keying features or use two short spacers to avoid interference. Spacers with holes can also be used to fasten the blocked housings to a surface with a fastener.

| Description | Part Numbers | |
|----------------------|--------------|---------|
| Minimum Quantity | 2,500 | 100 |
| Red, Short w/ Hole | 1399G1-BK | 1399G1 |
| Red, Long | 1399G2-BK | 1399G2 |
| Red, Short | 1399G6-BK | 1399G6 |
| Black, Long | 1399G10-BK | 1399G10 |
| Blue, Short | 1399G13-BK | 1399G13 |
| White, Short w/ Hole | 1399G14-BK | 1399G14 |
| White, Long | 1399G17-BK | 1399G17 |

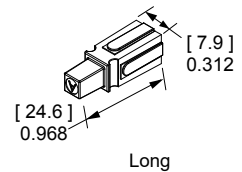
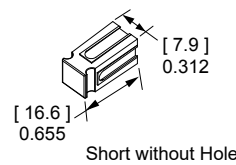
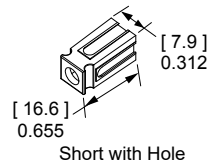

Retaining Pins

Keep stacked Powerpole® 15/45 series housings from separating. Retaining pins are inserted in the circular opening between two housings stacked side by side.

| Description | Part Numbers | | Dimensions | | | |
|------------------|--------------|--------|---------------|--------------|-------|--------|
| | | | - A - | | - B - | |
| | | inches | mm | inches | mm | |
| Minimum Quantity | 1,000 | 100 | | | | |
| 1 Block High | H1507P38 | 110G16 | 0.093 / 0.103 | 2.360 / 2.62 | 0.250 | 6.350 |
| 2 Block High | 111812P5 | 110G17 | 0.093 / 0.103 | 2.360 / 2.62 | 0.440 | 11.180 |

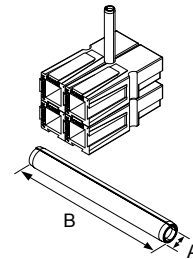

Mounting Clamp

Mounting clamps can be used for fastening a block of Powerpole® 15/45 series housings to a panel. Connector blocks must be a complete square for the clamps to work properly. Fastening hardware not included.

| Description | Part Numbers |
|------------------|---------------|
| Minimum Quantity | 100 sets of 2 |
| 2 or 4 Pole | 1462G1 |
| 3 or 6 Pole | 1462G2 |
| 4 or 8 Pole | 1462G3 |

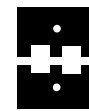
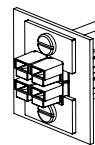

2 or 4 Pole

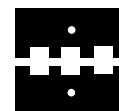

3 or 6 Pole

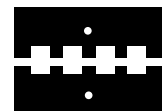

4 or 8 Pole

PCB Mounting Staples

PCB staples are soldered into place to secure Powerpole® 15/45 series housings in a horizontal configuration to the board. Reduce strain on soldering joints during mating and unmating.

| Part Numbers | H x W | Length | Dimensions | | | |
|----------------------|-------|--------|------------|------|--------|------|
| | | | - A - | | - B - | |
| | | | inches | mm | inches | mm |
| Minimum Quantity 100 | | | | | | |
| 114555P1 | 1 x 1 | Short | 0.47 | 12.0 | 0.28 | 7.0 |
| 114555P2 | 1 x 2 | Short | 0.47 | 12.0 | 0.57 | 14.5 |
| 114555P3 | 1 x 3 | Short | 0.47 | 12.0 | 0.89 | 22.5 |
| 114555P7 | 1 x 4 | Short | 0.47 | 12.0 | 1.20 | 30.5 |
| 114555P10 | 2 x 1 | Short | 0.79 | 20.0 | 0.28 | 7.0 |
| 114555P6 | 2 x 2 | Short | 0.79 | 20.0 | 0.57 | 14.5 |
| 114555P9 | 2 x 2 | Long | 0.91 | 23.0 | 0.57 | 14.5 |

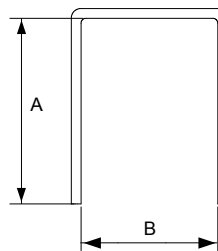

Retention Clip

Retention clips prevent Powerpole® 15/45 blocks from unintended disconnects. They feature a tab for easy insertion and removal.

| Description | Part Number |
|------------------|-------------|
| Minimum Quantity | 100 |
| 1 Block High | 110G68 |

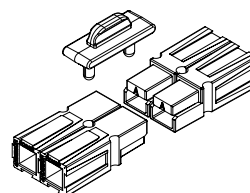

Block Lok

Block locks secure mated Powerpole® 15/45 series housings together. For use in high vibration or shock applications where connectors are unmated infrequently.

| Description | Part Numbers |
|------------------|--------------|
| Minimum Quantity | 100 |
| 2 Pole, Black | 110G21 |
| 4 Pole, Black | 110G12 |

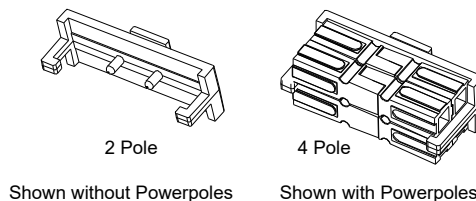

Splash Boot

Splash boots protect a 2x2 block of any combination of Powerpole® 15/45 series housings and feature snip off sealed ends for flexibility in wire O.D. Designed for through panel or inline applications. Not a hermetic seal.

| Description | Part Numbers |
|------------------|--------------|
| Minimum Quantity | 25 |
| Female, Black | 1441G1 |
| Male, Black | 1442G1 |

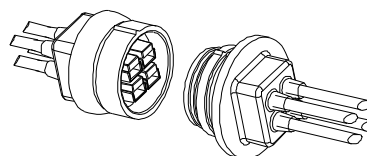

Dust Cover for Powerpole® Pak

Protect your Powerpole® Pak connector from most foreign material and potentially prevent premature degradation of the product. Contact customer service for the other possible configurations.

| Description | Part Numbers | | Dimensions - A - |
|------------------|--------------|----------|------------------|
| Minimum Quantity | 2,500 | 500 | |
| 2x2, Orange | 2-8831P1-BK | 2-8831P1 | 1.32 (33.5) |
| 2x3, Orange | 2-8831P2-BK | 2-8831P2 | 1.42 (36.0) |

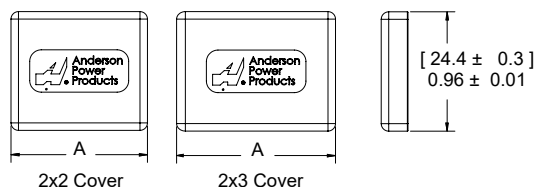

For environmentally sealed connector shells to hold Powerpole® 15 to 180 connectors, see SPEC Pak® product series on our website www.andersonpower.com



Powerpole® Connectors

PP75 - Up to 120 Amps



PP75 with Mounting Wings

PP75 series Powerpole® housings can be used for wire-to-wire, wire-to-board, and wire-to-busbar applications. Wire sizes from 16 to 6 AWG (1.3 to 13.3 mm²) offer power capabilities up to 120 amps per pole. Locking housings offer the capability to secure Powerpole® housings to each other and to mounting pads. Housings made from chemical resistant (CR) resin withstand industrial solvents better than standard housings.

- **Large Wire Range Accommodates up to 6 (10 mm²) Wire**
Reducing bushings allow as small as 16 AWG (1.5 mm²) wire to be used
- **Wire, PCB, and Busbar Contacts**
Allows one connection system to meet multiple needs
- **Mini-Powerclaw PCB Contacts Minimize PCB Footprint**
Removes the PP75 housing from the board side

POWERPOLE® PP75

PP75 ORDERING INFORMATION

PP75 Standard Housings

The second smallest Powerpole® housing can be used with wire contacts up to 6 AWG (10 mm²) as well as PCB and busbar contacts.

| Description | Part Numbers | |
|------------------|--------------|---------|
| Minimum Quantity | 1,000 | 100 |
| Red | 5916G7-BK | 5916G7 |
| Green | 5916G6-BK | 5916G6 |
| Black | 5916G4-BK | 5916G4 |
| White | 5916G5-BK | 5916G5 |
| Blue | 5916-BK | 5916 |
| Yellow | 5916G15-BK | 5916G15 |
| Orange | 5916G14-BK | 5916G14 |
| Gray | 5916G16-BK | 5916G16 |

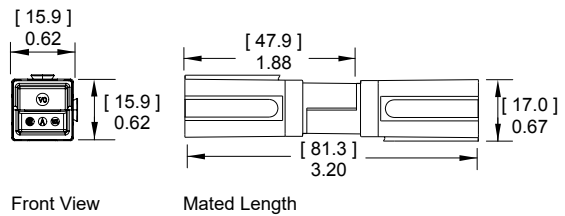

PP75 Chemical Resistant (CR) Housings

Has the same form and dimensions of the standard PP75 housing in a chemical resistant PBT / PC blend housing. Suitable for use to -40°C.

| Description | Part Numbers | |
|------------------|--------------|--|
| Minimum Quantity | 1,000 | |
| Red | P5916G7-BK | |
| Black | P5916G4-BK | |
| White | P5916G5-BK | |
| Blue | P5916-BK | |

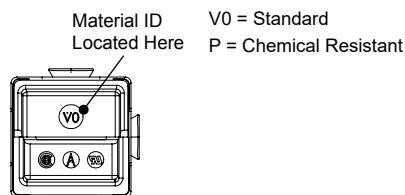

PP75 Locking Dovetail Housings

Offers dovetails for stacking housings that have a locking feature to prevent housings separating. Can mate to standard and chemical resistant housings, but cannot be stacked with them.

| Description | Part Numbers | |
|------------------|--------------|----------|
| Minimum Quantity | 1,000 | 100 |
| Red | 75LOKRED-BK | 75LOKRED |
| Green | 75LOKGRN-BK | 75LOKGRN |
| Black | 75LOKBLK-BK | 75LOKBLK |
| White | 75LOKWHT-BK | 75LOKWHT |
| Blue | 75LOKBLU-BK | 75LOKBLU |
| Gray | 75LOKGRA-BK | 75LOKGRA |

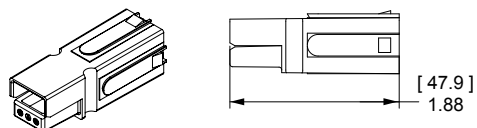

PP75 Premate Ground Housings

Offers a first-mate, last-break connection when stacked together with PP75 housings. Stacks together with PP75 standard and chemical resistant housings. Housings are mechanically keyed to prevent cross mating with power positions.

| Description | Part Numbers | |
|------------------|--------------|--------|
| Minimum Quantity | 1,000 | 100 |
| Green | 5927G6-BK | 5927G6 |

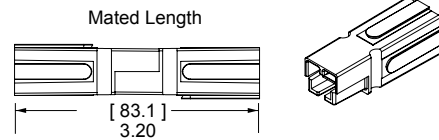

PP75 Silver Plated Wire Contacts

Silver plated contacts offer the best electrical performance and durability up to 10,000 mating cycles. See reducing bushings in accessory section for smaller wires.

| AWG | mm ² | Mating Force | Loose Piece Part Numbers | | Dimensions | |
|------------------|-----------------|--------------|--------------------------|------|--------------|------|
| | | | | | - A - inches | mm |
| Minimum Quantity | | | | | 1,000 | 100 |
| 6 | 13.3 | Low | 1307-BK | 1307 | 0.22 | 5.59 |
| 6 | 13.3 | High | 5900-BK | 5900 | 0.22 | 5.59 |
| 8 | 8.4 | High | 5952-BK | 5952 | 0.19 | 4.83 |
| 12 to 10 | 3.3 to 5.3 | Low | 5953-BK | 5953 | 0.14 | 3.56 |
| 12 to 10 | 3.3 to 5.3 | High | 5915-BK | 5915 | 0.14 | 3.56 |

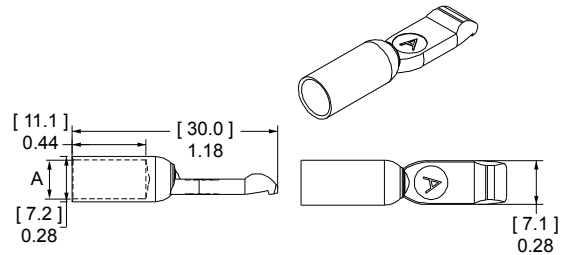

PP75 Premate Ground Wire Contacts

Silver plated contacts for use with the PP75 Premate Ground Housing. Rated to 10,000 mating cycles.

| Type | AWG | mm ² | Loose Piece Part Numbers | | Dimensions | |
|------------------|----------|-----------------|--------------------------|--------|--------------|------|
| | | | | | - A - inches | mm |
| Minimum Quantity | | | | | 1,000 | 100 |
| Individual | 6 | 13.3 | 1875G1-BK | 1875G1 | 0.22 | 5.59 |
| Individual | 8 | 8.4 | 1875G2-BK | 1875G2 | 0.19 | 4.83 |
| Individual | 12 to 10 | 3.3 to 5.3 | 1875G3-BK | 1875G3 | 0.14 | 3.56 |

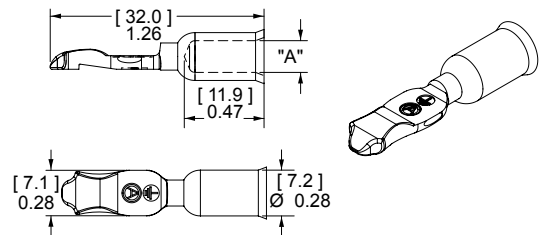

PP75 Silver Plated Busbar Contacts

Provide a quick disconnect input or output busbar connection. Busbar contacts are for mating with wire contacts only. Part number 75BBS includes lock nuts. Locknuts must be ordered separately for B01915P1.

| Type | Thread | Mating Force | Part Numbers | | | | |
|------------------|--------|--------------|--------------|--------|-------|----|----|
| Minimum Quantity | | | | | 1,000 | 20 | 10 |
| Busbar | 10-24 | High | B01915P1 | - | 75BBS | | |
| Lock Nut | 10-24 | - | H1216P8 | 110G54 | - | | |

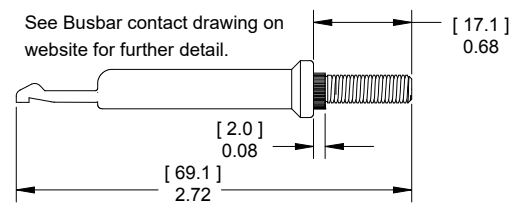

55A Right Angle Standard Powerclaw PCB Contacts

Standard Powerclaw contacts are for use inside a PP75 housing and provide a color-coded right angle connection to the PCB.

| Description | Loose Piece Part Numbers | |
|------------------|--------------------------|---------|
| Minimum Quantity | 500 | 100 |
| Tin Plated | PC5930T-BK | PC5930T |
| Silver Plated | PC5930S-BK | PC5930S |

See PCB contact drawing on website for further detail.

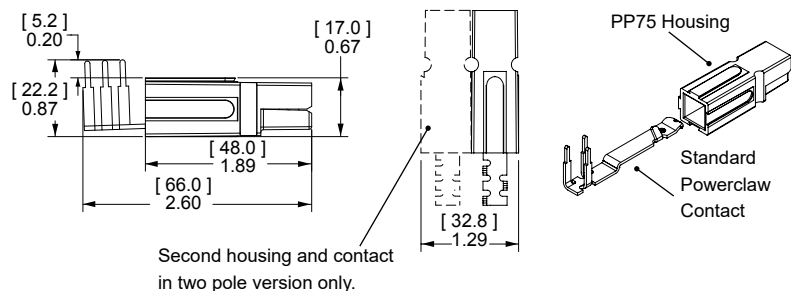

55A Right Angle Mini Powerclaw PCB Contacts

Right angle Mini Powerclaw contacts can be used on the PCB edge without a PP75 housing on the PCB side. A self polarizing design only allow PP75 wire housings to mate to PCB contacts one way.

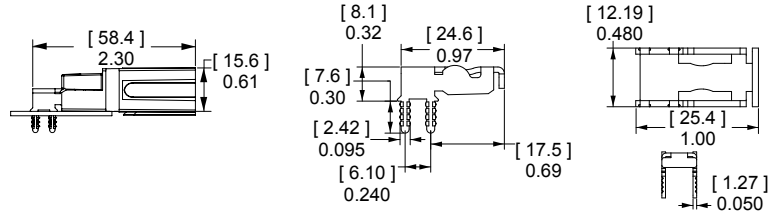

| Description | Loose Piece | |
|------------------|--------------|---------|
| | Part Numbers | |
| Minimum Quantity | 1,000 | 100 |
| Tin Plated | PC5934T-BK | PC5934T |
| Silver Plated | PC5934S-BK | PC5934S |

55A Vertical Mini Powerclaw PCB Contacts

Vertical Mini Powerclaw contacts save space by not requiring a PP75 housing on the PCB side. The guide housing is required for 2 pole applications to provide a polarized connection. (See PP75 accessories).

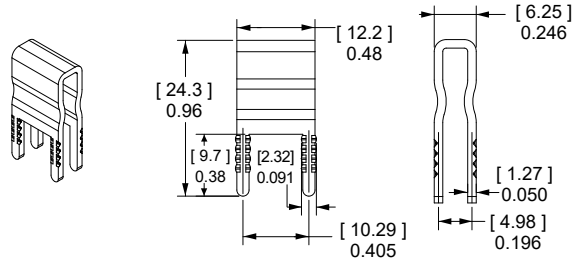

| Description | Loose Piece | |
|------------------|--------------|---------|
| | Part Numbers | |
| Minimum Quantity | 1,500 | 100 |
| Tin Plated | PC5933T-BK | PC5933T |
| Silver Plated | PC5933S-BK | PC5933S |

See PCB contact drawing on website for further detail.

PP75 CONNECTOR TEMPERATURE CHARTS - Temperature rise charts are based on a 25°C ambient temperature.

Current - Temperature Derating per IEC 60512-5-2 Test 5B

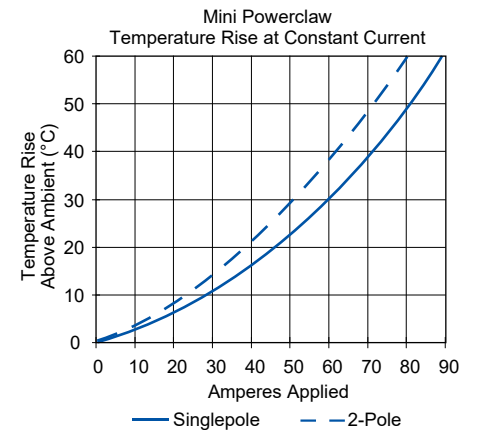
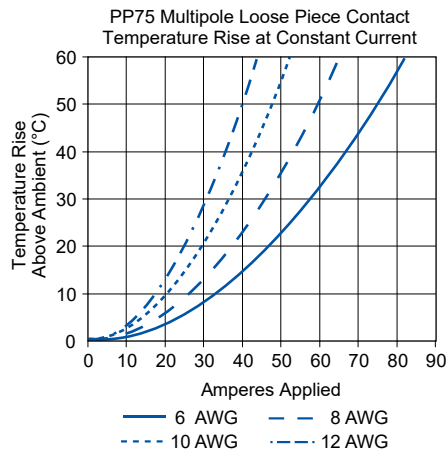
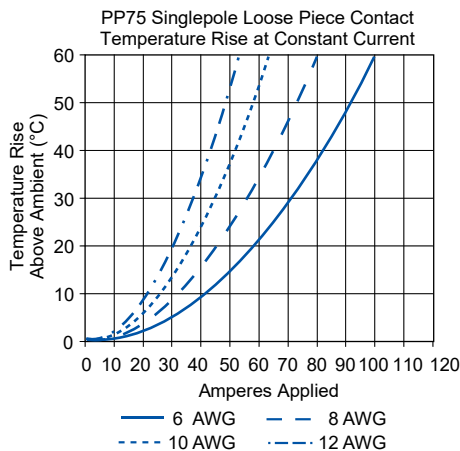
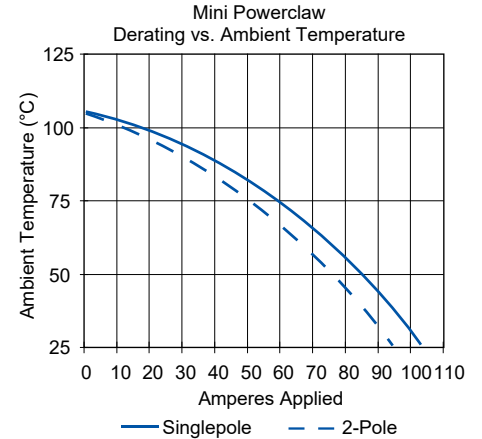
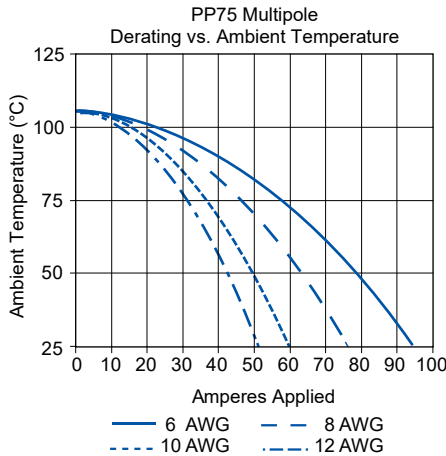
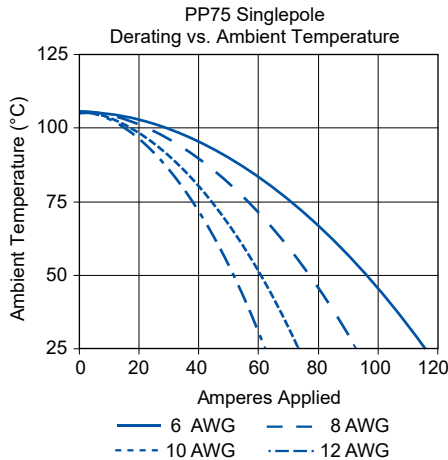

NOTE: Powerclaw charts are based on 8 AWG equivalent copper foil on board side, mated to 6 AWG conductor on wire side.

PP75 SPECIFICATIONS

| ELECTRICAL | | |
|--|----------------|------------|
| Current Rating Amperes ¹ | UL 1977 | CSA |
| Wire-to-Wire (6 AWG) | 120 | 70 |
| Wire-to-PCB (6 AWG) | 55 | 50 |
| Wire-to-Busbar (6 AWG) | 75 | |
| Voltage Rating AC/DC | | |
| UL 1977 | 600 | |
| PCB Connector Recommended Voltage ³ | | |
| per IEC 60950-1 Table 2L Pollution Degree ² | | |
| Mini Vert. Contact Adjacent Poles | 220 | |
| Mini Horiz. Contact Adjacent Poles | 200 | |
| Standard Contact Adjacent Poles | 635 | |
| Dielectric Withstanding Voltage | | |
| Volts AC | 2,200 | |
| Avg. Mated Contact Resistance Milliohms ¹ | | |
| Wire Contact with 1 1/4" of 6 AWG | 0.200 | |
| PCB Contact to Contact | 0.500 | |
| UL Hot Plug Current Rating Amperes - 250 Cycles at 120V DC ⁶ | | |
| Wire-to-Wire | 50A | |
| PCB to Wire (Vertical Mini Powerclaw) | 40A | |
| UL Ground Short Time Current Test - 75A Premate Ground | | |
| 1530 Amps, 6 AWG Wire | 6 Seconds | |

| MATERIAL | | |
|------------------------------------|-----------------------------|--|
| Housing | | |
| Standard Plastic Resin | Polycarbonate | |
| Chem. Resistant Resin | Polycarbonate / PBT blend | |
| Contact Retention Spring | Stainless Steel | |
| Housing Flammability Rating | | |
| UL94 | V-0 | |
| Glow Wire | 960°C (GWFI) / 800°C (GWIT) | |
| Contact | | |
| Base | Copper Alloy | |
| Wire Plating | Silver | |
| PCB Plating | Sn or Ag over Ni | |
| Contact Termination Methods | | |
| Crimp ⁴ | Wire Contacts | |
| Hand Solder | Wire and PCB Contacts | |
| Solder Dip | PCB Contacts | |
| Wave Solder | PCB Contacts | |
| Wrench / Socket | Busbar Contacts | |

| MECHANICAL | | |
|---|--|-----------------------|
| Wire Size Range | AWG | mm² |
| Wire Contacts with Bushings | 16 to 6 | 1.3 to 13.3 |
| Max. Wire Insulation Diameter | in. | mm |
| | 0.437 | 11.100 |
| Operating Temperature ² | °F | °C |
| Standard & Ground | -4° to 221° | -20° to 105° |
| Chemical Resistant* | -40 to 221° | -40° to 105° |
| *Chemical resistant material not available for PCB guide housings | | |
| Mating Cycles No Load by Plating | Silver (Ag) | Tin (Sn) |
| Wire and PCB Contacts | 10,000 | 1,500 |
| Avg. Mating / Unmating Force | Lbf. | N |
| Wire to Wire Low Force Contacts | 5 | 22 |
| Wire to Wire High Force Contacts | 7 | 31 |
| Standard Powerclaw to Wire | 7 | 31 |
| Mini Powerclaw to Wire | 4 | 17 |
| PCB Specifications | | |
| Mounting Style | Plated Through Hole | |
| Max PCB Thickness - in. (mm) | Standard: 0.15 (0.381) Mini: 0.25 (0.635) | |
| Recommended Traces | 8 AWG Cross Section | |
| Min. Contact / Spring Retention Force | Lbf. | N |
| Wire Housing | 50 | 222 |
| Min. Creepage / Clearance Distance PCB | in. | mm |
| Standard Powerclaw Adjacent Poles | 0.260 | 6.6 |
| Mini Vert. Powerclaw Adjacent Poles | 0.087 | 2.2 |
| Mini Horiz. Powerclaw Adjacent Poles | 0.079 | 2.0 |
| Mechanical Shock ⁵ | | |
| MIL-STD-202 | 213 Condition A | 50g's |
| Vibration High Frequency ⁵ | 204 Condition A | 10g's |



NOTE 1: See IEC 60664-1 for working voltage.

NOTE 2: Amp ratings are stated per position and based on all positions being fully loaded.

- 1 - Based on: 105°C rated or better cable of the largest size. Properly calibrated APP® recommended tooling, and a 25°C ambient temperature. UL rating not to exceed the maximum operating temperature. CSA rating below a 30°C temperature rise.
- 2 - Limited by the thermal properties of the connector plastic housing.
- 3 - Without use of spacers to increase creepage and clearance distances.
- 4 - Use APP® recommended tooling only. Alternate tools may adversely affect the performance of our connectors along with UL and CSA recognition.
- 5 - Tested with contact part number 5900.
- 6 - Based on 2 housings blocked together.

IEC INFORMATION

| Connector Series | Configurations | Creepage / Clearance per IEC 60950-1 | Material Group | |
|------------------|--------------------|--------------------------------------|----------------|------|
| PP75 | Single Pole | Unmated | 2.97 mm | |
| | | Mated | 2.97 mm | |
| | Stacked Powerpole® | Unmated | 2.97 mm | IIIa |
| | | Mated | 2.97 mm | |

| ATTRIBUTES | PP75 |
|---|---|
| AMP Rating AC/DC | 75 |
| Voltage Rating AC/DC (Steady State) | 250 V AC/DC (Operational) |
| Breaking Capacity - AMP Rating / Cycles | 75 Amp / 10 Cycles |
| Voltage Rating (Breaking Capacity) | 220 VDC |
| FINGER Safety - Mated Only | IEC 60529 - IP20 |
| Wire Size Tested | 16 mm ² |
| Contact Series Tested | 5900 |
| Climatic Testing (Cold, Heat & MFG) | IEC 60512 Test-11j, 11i & 11g |
| Cycle Life | IEC 60512 Test 9a - 5,000 Cycles |
| Mechanical Strength Impact | IEC 60512-5 @ 29.5 Inches - Dropped 8 Times |
| Temperature Range | -20°C to 105°C -4°F to 221°F |

PROTECTION

Touch Safety with Wire Contacts

IEC 60529 IP10



POWERPOLE® PP75 ACCESSORIES

Strain Relief Grommets

Use for strain relief in the back side of a PP75 housing. Wire gauge given for reference only, use grommet ID and wire OD to determine suitability in the end application.

| Description | Part Numbers | Dimensions - A - | |
|---------------------|--------------|---------------------|------|
| | | inches | mm |
| Minimum Quantity | 100 | | |
| 6 AWG, Black | 114411P2 | 0.35 | 8.89 |
| 8 AWG, Black | 114411P1 | 0.25 | 6.35 |
| 10 to 12 AWG, Black | 114411P3 | 0.17 | 4.32 |

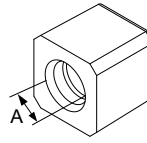

Mounting Wing for Standard or CR Housings

Mounting wings can be used to secure dovetailed Powerpole® 75 series housings by passing fasteners through the wings in either a horizontal or vertical orientation. Useful for sheet metal panels, printed circuit boards, and many other mounting surfaces. Fasteners not included.

| Description | Part Numbers | |
|------------------|--------------|---------|
| Minimum Quantity | 1,000 | 100 |
| Blue, Round Hole | 1399G20-BK | 1399G20 |
| Blue, Oval Hole | 1399G7-BK | 1399G7 |

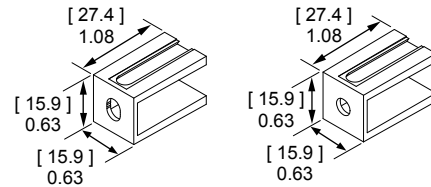

Mounting Wing for Locking Housings

Mounting wings can be used to secure Powerpole® 75 series housings with locking dovetails by passing fasteners through the wings in either a horizontal or vertical orientation. Useful for sheet metal panels, printed circuit boards, and many other mounting surfaces. Fasteners not included.

| Description | Part Numbers | |
|------------------|------------------|---------------|
| Minimum Quantity | 1,000 | 100 |
| Blue, Oval Hole | 75LOKWNGBLU-BK | 75LOKWNGBLU |
| Blue, Round Hole | 75LOKWNGBLU-R-BK | 75LOKWNGBLU-R |

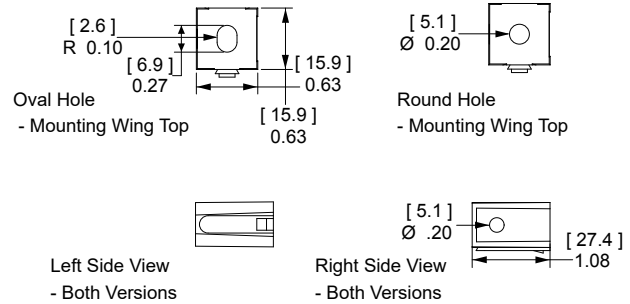

Surface Mount for Locking Housings

Use to secure Powerpole® 75 series housings with locking dovetails to a flat surface. Useful for sheet metal panels, printed circuit boards, and many other mounting surfaces. Fasteners not included.

| Description | Part Numbers | |
|------------------|----------------|-------------|
| Minimum Quantity | 1,000 | 100 |
| Blue | 75LOKSMTBLU-BK | 75LOKSMTBLU |

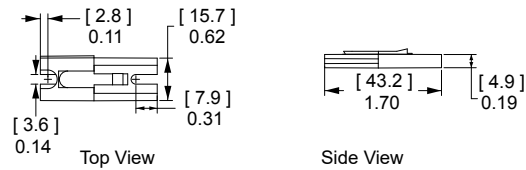

Spacer

Use to separate housings under high power to minimize power capability derating due to heat rise. They are recommended for squaring off a block of Powerpole® 75 housings to enable mounting accessories or retaining pins to be used. Combining long and short spacers opposite each other in a mated block adds keying features, or use two short spacers to avoid interference.

| Description | Part Numbers | |
|------------------|--------------|---------|
| Minimum Quantity | 1000 | 100 |
| Red, Short | 1399G23-BK | 1399G23 |
| Red, Long | 1399G21-BK | 1399G21 |

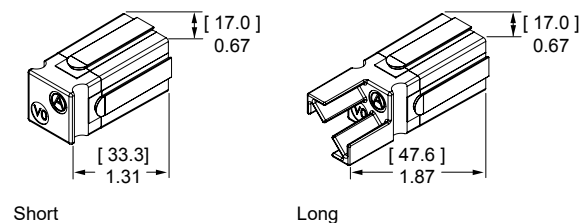

Guide Housings for Vertical Mini Powerclaw Contacts

Prevents polarity being reversed when a two pole PP75 block is mated to vertical mini Powerclaw contacts. Fastening hardware not included.

| Description | Part Numbers | |
|---------------------|--------------|-----------|
| Minimum Quantity | 1,000 | 100 |
| Black Guide Housing | PC-HSG-PP-BK | PC-HSG-PP |

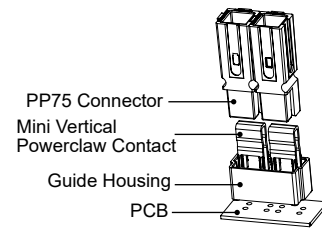

Mounting Clamp

Mounting clamps can be used for fastening a block of Powerpole® 75 series housings to a panel. Connector blocks must be a complete square for the clamps to work properly. Fastening hardware not included.

| Description | Part Numbers | |
|------------------|--------------|--|
| Minimum Quantity | 50 sets of 2 | |
| 2 or 4 Pole | 1463G1 | |
| 3 or 6 Pole | 1463G2 | |

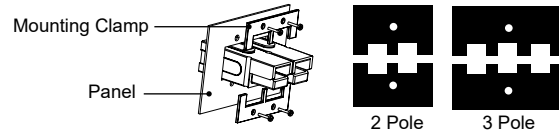

Retaining Pins

Retaining pins are used to keep stacked Powerpole® 75 series housings from separating. Retaining pins are inserted in the circular opening between two housings stacked side by side. Dimension B is +/- 0.015 in or 0.38 mm.

| Description | Part Numbers | | Dimensions | | | |
|------------------|--------------|--------|---------------|-------------|--------|--------|
| | | | - A - | | - B - | |
| | | | inches | mm | inches | mm |
| Minimum Quantity | 1,000 | 100 | | | | |
| 1 Block High | 111812P7 | 110G19 | 0.196 / 0.207 | 4.98 / 5.26 | 0.560 | 14.220 |
| 2 Block High | 111812P6 | 110G18 | 0.196 / 0.207 | 4.98 / 5.26 | 1.000 | 25.400 |

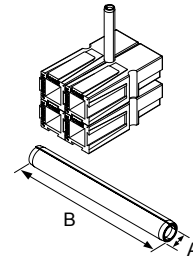

PCB Mounting Staples

Reduce strain on solder joints during mating and unmating. Staples bend over the underside of the PCB board to lock the housings in place. Staples are an interference fit with housings.

| Part Number | Number of Stacked Powerpole® H x W | |
|------------------|------------------------------------|--|
| Minimum Quantity | 100 | |
| PCSTAPLE-2 | 1 x 2 | |

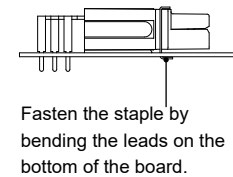
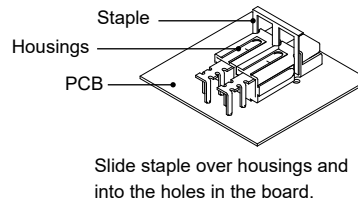

Reducing Bushings

Use with contact part number 5900-BK or 1307-BK to allow a smaller wire to be used with the connector. Electrical capability is derated with smaller wire.

| Contact Barrel Size | | Wire Size | | Part Numbers | | Dimensions | | | | |
|---------------------|-----------------|-----------|-----------------|--------------|---------|------------|------|------------|------|-------|
| AWG | mm ² | AWG | mm ² | | | - ID - | | - Length - | | |
| | | | | | | inches | mm | Inches | mm | |
| Minimum Quantity | | | | 3,000 | 1,000 | 100 | | | | |
| 6 | 13.3 | 8 | 8.4 | - | 5912-BK | 5912 | 0.18 | 4.57 | 0.45 | 11.43 |
| 6 | 13.3 | 12 to 10 | 3.3 to 5.3 | 5910-BK | - | 5910 | 0.14 | 3.56 | 0.47 | 11.94 |
| 6 | 13.3 | 16 to 14 | 1.3 to 2.1 | 5913-BK | - | 5913 | 0.09 | 2.29 | 0.47 | 11.94 |

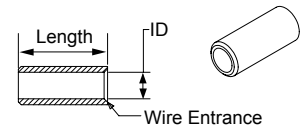

For environmentally sealed connector shells to hold Powerpole® 15 to 180 connectors, see SPEC Pak® product series on our website www.andersonpower.com



Powerpole® Connectors

PP120 - Up to 240 Amps

POWERPOLE® PP120



PP120 series Powerpole® housings are designed to accommodate up to 1/0 AWG (50 mm²) wires and handle high currents up to 240 amps. Reducing bushings allow PP120 to accept down to 8 AWG (10 mm²) wires. Multiple colors of stackable housings combine with low resistance flat wiping technology to offer powerful connection capability.

- Large Wire Range Accommodates up to 1/0 (50 mm²) Wire**
Reducing bushings allow as small as 8 (10 mm²) wire to be used
- Low Resistance Silver Plated Copper Contacts**
Allows currents up to 240 amps
- UL Rated for Hot Plugging up to 60 Amps**
Great for battery or other applications where the ability to interrupt circuits is required

PP120 ORDERING INFORMATION

PP120 Housings

The second to largest Powerpole® housing can be used with wire contacts for up to 1/0 AWG (50 mm²) or busbar contacts.

| Description | Part Numbers | |
|------------------|--------------|--------|
| Minimum Quantity | 500 | 50 |
| Blue | 1321-BK | 1321 |
| Black | 1321G1-BK | 1321G1 |
| White | 1321G2-BK | 1321G2 |
| Red | 1321G3-BK | 1321G3 |
| Green | 1321G4-BK | 1321G4 |
| Orange | 1321G5-BK | 1321G5 |
| Brown | 1321G6-BK | 1321G6 |
| Yellow | 1321G7-BK | 1321G7 |
| Gray | 1321G8-BK | 1321G8 |

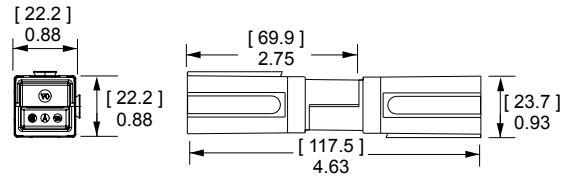

PP120 Silver Plated Wire Contacts

Silver plated contacts offer superior electrical performance and durability up to 10,000 mating cycles. New contacts for 1 to 1/0 AWG (35 to 50 mm²) offer extended capability in the same housings. See reducing bushings in accessory section for smaller wires.

| AWG | mm ² | Mating Force | Loose Piece Part Numbers | | | - A - | | - B - | |
|-----|-----------------|--------------|--------------------------|-----------|----------|--------|-------|--------|-------|
| | | | 600 | 500 | 50 | inches | mm | inches | mm |
| 1/0 | 53.5 | Low | 1323G2-BK | - | 1323G2 * | 0.52 | 13.21 | 0.44 | 11.18 |
| 1 | 42.4 | Low | 1323G1-BK | - | 1323G1 * | 0.47 | 11.94 | 0.39 | 9.91 |
| 2 | 33.6 | High | - | 1319-BK | 1319 | 0.44 | 11.18 | 0.34 | 8.64 |
| 4 | 21.1 | High | - | 1319G4-BK | 1319G4 | 0.44 | 11.18 | 0.29 | 7.37 |
| 6 | 13.3 | High | - | 1319G6-BK | 1319G6 | 0.44 | 11.18 | 0.22 | 5.59 |

* Extended range

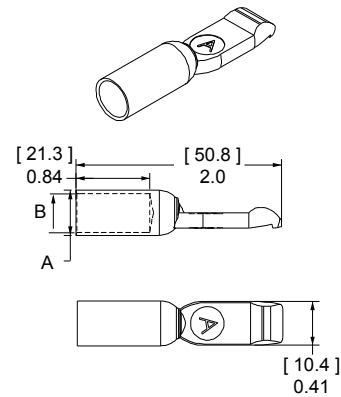

PP120 CONNECTOR TEMPERATURE CHARTS - Temperature rise charts are based on a 25°C ambient temperature.

Current - Temperature Derating per IEC 60512-5-2 Test 5B

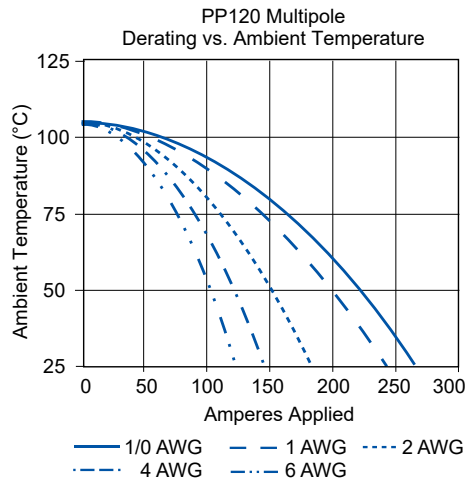
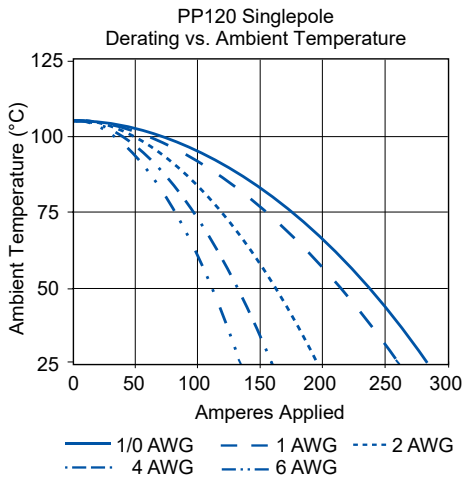
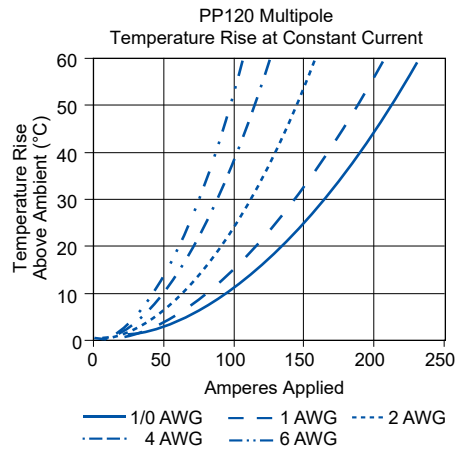
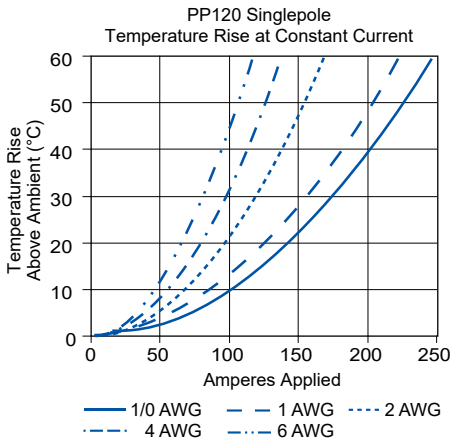

POWERPOLE® PP120

PP120 SPECIFICATIONS

ELECTRICAL

| | | |
|---|----------------|------------|
| Current Rating Amperes ¹ | UL 1977 | CSA |
| Singlepole UL 1977 (1/0 AWG) | 240 | 155 |
| 2x2 Block UL 1977 (1/0 AWG) | 200 | 110 |
| Voltage Rating AC/DC | | |
| UL 1977 | 600 | |
| Dielectric Withstanding Voltage | | |
| Volts AC | 2,200 | |
| Avg. Mated Contact Resistance Milliohms ¹ | | |
| 5 1/2" of 2 AWG Wire | 0.136 | |
| UL Hot Plug Current Rating Amperes ⁴ | | |
| 250 Cycles at 120V DC | 60A | |

MATERIALS

Housing

| | |
|--------------------------|-----------------|
| Plastic Resin | Polycarbonate |
| Contact Retention Spring | Stainless Steel |

Housing Flammability Rating

| | |
|-----------|-----------------------------|
| UL94 | V-0 |
| Glow Wire | 960°C (GWFI) / 850°C (GWIT) |

Contact

| | |
|---------|--------------|
| Base | Copper Alloy |
| Plating | Silver |

Contact Termination Methods

| | |
|--------------------|---------------|
| Crimp ³ | Wire Contacts |
| Hand Solder | Wire Contacts |

MECHANICAL

| | | |
|--|--------------------|-----------------------|
| Wire Size Range | AWG | mm² |
| Wire Contacts with Bushings | 10 to 1/0 | 5.3 to 53.5 |
| Max. Wire Insulation Diameter | in. | mm |
| | 0.600 | 15.240 |
| Operating Temperature ² | °F | °C |
| | -4° to 221° | -20° to 105° |
| Mating Cycles No Load by Plating | Silver (Ag) | |
| Wire Contacts | 10,000 | |
| Avg. Mating / Unmating Force | Lbf. | N |
| | 8 | 36 |
| Min. Contact / Spring Retention Force | Lbf. | N |
| | 60 | 267 |



File No. E26221



CSA Certified
File No. LR25154



NOTE 1: See IEC 60664-1 for working voltage.

NOTE 2: Amp ratings are stated per position and based on all positions being fully loaded.

- 1 - Based on: 105°C rated or better cable of the largest size. Properly calibrated APP® recommended tooling, and a 25°C ambient temperature. UL rating not to exceed the maximum operating temperature. CSA rating below a 30°C temperature rise.
- 2 - Limited by the thermal properties of the connector plastic housing.
- 3 - Use APP® recommended tooling only. Alternate tools may adversely affect the performance of our connectors along with UL and CSA recognition.
- 4 - Based on 2 housings blocked together.

IEC INFORMATION

| Connector Series | Configurations | Creepage / Clearance per IEC 60950-1 | Material Group |
|------------------|--------------------|--------------------------------------|----------------|
| PP120 | Single Pole | Unmated | 4.36 mm |
| | | Mated | 4.36 mm |
| | Stacked Powerpole® | Unmated | 4.36 mm |
| | | Mated | 4.36 mm |

PROTECTION

Touch Safety with Wire Contacts

| | |
|-----------|------|
| IEC 60529 | IP10 |
|-----------|------|



| ATTRIBUTES | PP120 |
|--|---|
| AMP Rating AC/DC | 120 |
| Voltage Rating AC/DC (Steady State) | 400 V AC/DC (Operational) |
| Breaking Capacity - AMP Rating / Cycles | 120 Amp / 10 Cycles |
| Voltage Rating (Breaking Capacity) | 220 VDC |
| FINGER Safety - Mated Only | IEC 60529- IP20 |
| Wire Size Tested | 50 mm ² |
| Contact Series Tested | 1323G2 |
| Climatic Testing (Cold, Heat & MFG) | IEC 60512 Test- 11j, 11i & 11g |
| Cycle Life | IEC 60512 Test 9a- 5,000 Cycles |
| Mechanical Strength Impact | IEC 60512-5 @ 29.5 Inches-Dropped 8 times |
| Temperature Range | -20°C to 105°C -4°F to 221°F |

POWERPOLE® PP120 ACCESSORIES

Mounting Clamp

Mounting clamps can be used for fastening a block of Powerpole® 120 series housings to a panel. Connector blocks must be a complete square for the clamps to work properly. Fastening hardware not included.

| Description | Part Numbers |
|------------------|--------------|
| Minimum Quantity | 20 sets of 2 |
| 2 Pole | 1464G1 |
| 3 Pole | 1464G2 |

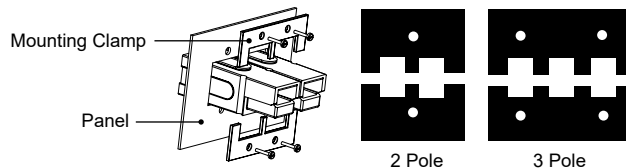

Retaining Pins

Retaining pins are used to keep stacked Powerpole® 120 series housings from separating. Retaining pins are inserted in the circular opening between two housings stacked side by side. Dimension B is +/- 0.015 in or 0.38 mm.

| Description | Part Numbers | | Dimensions | | | |
|------------------|--------------|--------|---------------|-------------|--------|--------|
| | | | - A - | | - B - | |
| | | | inches | mm | inches | mm |
| Minimum Quantity | 1,000 | 100 | | | | |
| 1 Block High | 111812P7 | 110G19 | 0.196 / 0.207 | 4.98 / 5.26 | 0.560 | 14.220 |
| 2 Block High | 111812P8 | 110G20 | 0.196 / 0.207 | 4.98 / 5.26 | 1.500 | 38.100 |

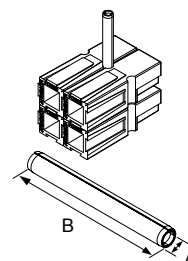

Reducing Bushings

Use with contact part number 1319-BK to allow a smaller wire to be used with the connector. Electrical capability is derated with smaller wire.

| Contact Barrel Size | | Wire Size | | Part Numbers | | | Dimensions - ID - | |
|---------------------|-----------------|-----------|-----------------|--------------|---------|------|-------------------|------|
| AWG | mm ² | AWG | mm ² | | | | inches | mm |
| Minimum Quantity | | | | 2,000 | 1,000 | 100 | | |
| 2 | 33.6 | 4 | 21.2 | 5919-BK | - | 5919 | 0.28 | 7.11 |
| 2 | 33.6 | 6 | 16 | - | 5920-BK | 5920 | 0.23 | 5.84 |
| 2 | 33.6 | 10 to 8 | 5.3 to 8.4 | 5921-BK | | 5921 | 0.18 | 4.57 |

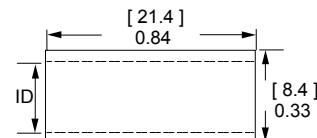

NOTE: Combination of a bushing and contact is not UL approved.

For environmentally sealed connector shells to hold Powerpole® 15 to 180 connectors, see SPEC Pak® product series on our website www.andersonpower.com



Powerpole® Connector

PP180 - Up to 350 Amps

POWERPOLE® PP180

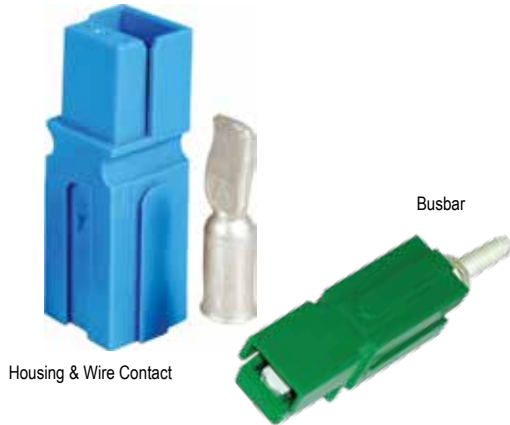

PP180 are the largest of the Powerpole® series housings. They are designed to accommodate up to 3/0 (70 mm²) wires and handle high currents up to 350 amps. Busbar contacts are also available for power inputs and takeoffs. Color-coded housings minimize user confusion and the potential of cross mating circuits.

- **Low Resistance Silver Plated Copper Contacts**

Allows currents up to 350 amps

- **UL Rated for Hot Plugging up to 75 Amps**

Great for battery or other applications where the ability to interrupt circuits is required

- **Busbar Contacts Work with Standard Housings**

Provides a hot swappable quick disconnect system for busbar power distribution

PP180 ORDERING INFORMATION

PP180 Housings

The largest Powerpole® housing can be used with wire contacts for up to 3/0 AWG (85 mm²) or busbar contacts.

| Description | Part Numbers | |
|------------------|--------------|--------|
| Minimum Quantity | 250 | 50 |
| Red | 1381G3-BK | 1381G3 |
| Green | 1381G4-BK | 1381G4 |
| Black | 1381G1-BK | 1381G1 |
| White | 1381G2-BK | 1381G2 |
| Blue | 1381-BK | 1381 |

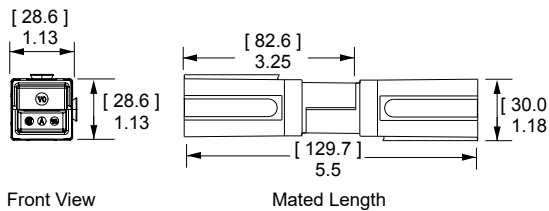

PP180 Silver Plated Wire Contacts

Silver plated contacts offer superior electrical performance and durability up to 10,000 mating cycles. New contacts for 2/0 to 3/0 AWG (70 to 85 mm²) offer extended capability in the same housings. See Reducing bushings in accessory section for smaller wires.

| AWG | mm ² | Mating Force | Loose Piece Part Numbers | | | | Dimensions | | | | | | | |
|------------------|-----------------|--------------|--------------------------|-----------|-----------|----------|------------|-------|--------|-------|--------|-------|--------|-------|
| | | | 500 | 300 | 250 | 50 | - A - | | - B - | | - C - | | - D - | |
| | | | | | | | inches | mm | inches | mm | inches | mm | inches | mm |
| Minimum Quantity | | | | | | | | | | | | | | |
| 3/0 | 85 | Low | - | - | 1328G2-BK | 1328G2 * | 2.35 | 59.69 | 0.70 | 17.78 | 0.58 | 14.73 | 1.04 | 26.42 |
| 2/0 | 67.4 | Low | - | 1328G1-BK | - | 1328G1 * | 2.35 | 59.69 | 0.64 | 16.26 | 0.49 | 12.45 | 1.04 | 26.42 |
| 1/0 | 53.5 | High | 1382-BK | - | - | 1382 | 2.35 | 59.69 | 0.52 | 13.21 | 0.44 | 11.18 | 1.04 | 26.42 |
| 1 | 42.4 | High | 1347-BK | - | - | 1347 | 2.35 | 59.69 | 0.52 | 13.21 | 0.39 | 9.91 | 1.04 | 26.42 |
| 2 | 33.6 | High | 1383-BK | - | - | 1383 | 2.35 | 59.69 | 0.52 | 13.21 | 0.35 | 8.89 | 1.04 | 26.42 |
| 4 | 21.1 | High | 1384-BK | - | - | 1384 | 2.35 | 59.69 | 0.52 | 13.21 | 0.30 | 7.62 | 1.04 | 26.42 |
| 6 | 13.3 | High | 1348-BK | - | - | 1348 | 2.10 | 53.34 | 0.37 | 9.40 | 0.22 | 5.59 | 0.80 | 20.32 |

* Extended range

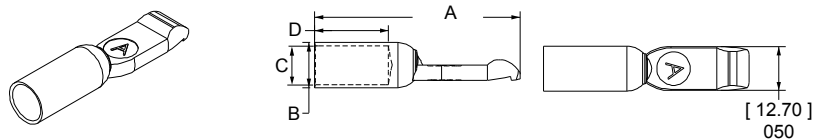

PP180 Silver Plated Busbar Contacts

Use 1 busbar contacts per housing to provide a quick disconnect input or output busbar connection. Busbar contacts are for mating with wire contacts only. Part number 180BBS includes lock nuts. Locknuts must be ordered separately for 180BBS-BK.

| Thread | Mating Force | Loose Piece Part Numbers | | |
|------------------|--------------|--------------------------|--------|--------|
| Minimum Quantity | | 1,000 | 120 | 10 |
| Busbar 1/4-20 | High | 180BBS-BK | 180BBS | - |
| Lock Nut 1/4-20 | N/A | H1216P7 | 110G56 | 110G55 |

See Busbar contact drawing on website for further detail.

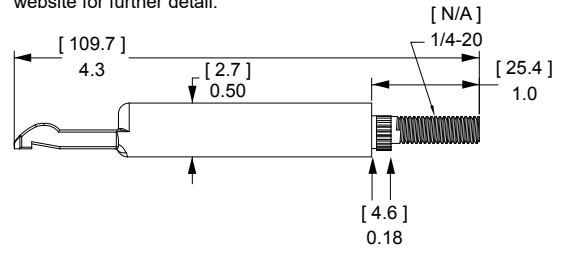

PP180 CONNECTOR TEMPERATURE CHARTS - Temperature rise charts are based on a 25°C ambient temperature.

Current - Temperature Derating per IEC 60512-5-2 Test 5B

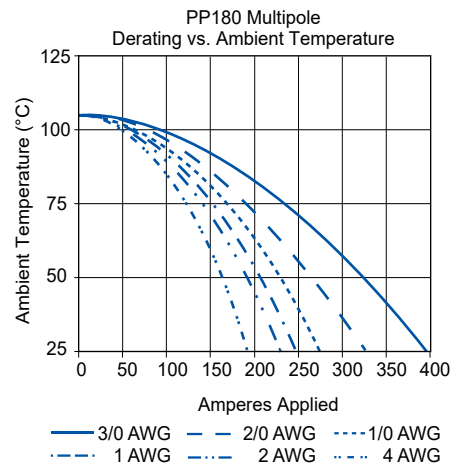
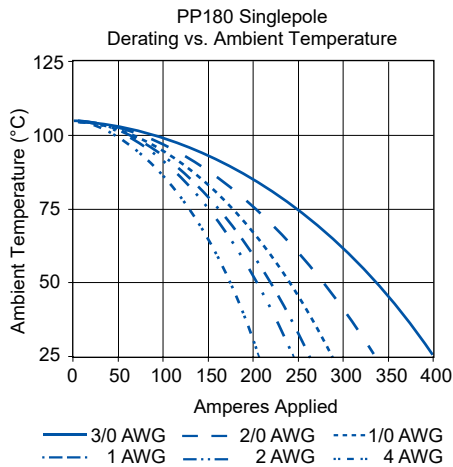
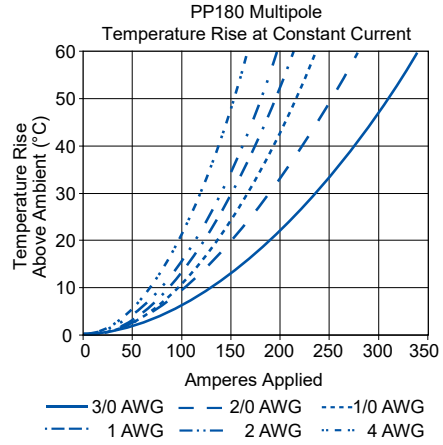
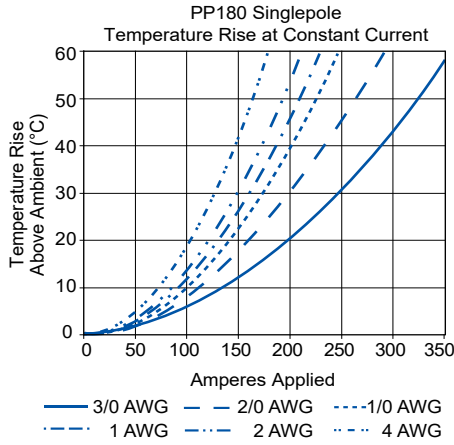

POWERPOLE® PP180

PP180 SPECIFICATIONS

ELECTRICAL

| Current Rating Amperes ¹ | UL 1977 | CSA |
|---------------------------------------|---------|-----|
| Singlepole (Wire-to-Wire) (3/0 AWG) | 350 | 230 |
| 2x2 Block (Wire-to-Wire) (3/0 AWG) | 350 | |
| Singlepole (Wire-to-Busbar) (1/0 AWG) | 180 | |

Voltage Rating AC/DC

| | |
|---------|-----|
| UL 1977 | 600 |
|---------|-----|

Dielectric Withstanding Voltage

| | |
|----------|-------|
| Volts AC | 2,200 |
|----------|-------|

Avg. Mated Contact Resistance Milliohms ¹

| | |
|--------------------|-------|
| 6" of 1/0 AWG Wire | 0.100 |
|--------------------|-------|

UL Hot Plug Current Rating Amperes ⁴

| | |
|-----------------------|-----|
| 250 Cycles at 120V DC | 75A |
|-----------------------|-----|

MATERIALS

Housing

| | |
|--------------------------|-----------------|
| Plastic Resin | Polycarbonate |
| Contact Retention Spring | Stainless Steel |

Housing Flammability Rating

| | |
|-----------|-----------------------------|
| UL94 | V-0 |
| Glow Wire | 960°C (GWFI) / 850°C (GWIT) |

Contact

| | |
|---------|--------------|
| Base | Copper Alloy |
| Plating | Silver |

Contact Termination Methods

| |
|--------------------|
| Crimp ³ |
| Hand Solder |
| Wrench / Socket * |

* Busbar Contacts Only

MECHANICAL

| Wire Size Range | AWG | mm ² |
|-----------------------------|-----------|-----------------|
| Wire Contacts with Bushings | 10 to 3/0 | 5.3 to 85 |

| Max. Wire Insulation Diameter | in. | mm |
|-------------------------------|-------|--------|
| | 0.900 | 22.860 |

| Operating Temperature ² | °F | °C |
|------------------------------------|-------------|--------------|
| | -4° to 221° | -20° to 105° |

| Mating Cycles No Load by Plating | Silver (Ag) | N |
|----------------------------------|-------------|----|
| Wire and Busbar Contacts | 10,000 | 44 |

| Avg. Mating / Unmating Force | Lbf. | N |
|------------------------------|------|----|
| Wire & Busbar Contacts | 10 | 44 |

| Min. Contact / Spring Retention Force | Lbf. | N |
|---------------------------------------|------|-----|
| | 120 | 534 |



NOTE 1: See IEC 60664-1 for working voltage.

NOTE 2: Amp ratings are stated per position and based on all positions being fully loaded.

- 1 - Based on: 105°C rated or better cable of the largest size, Properly calibrated APP® recommended tooling, and a 25°C ambient temperature. UL rating not to exceed the maximum operating temperature. CSA rating below a 30°C temperature rise.
- 2 - Limited by the thermal properties of the connector plastic housing.
- 3 - Use APP® recommended tooling only. Alternate tools may adversely affect the performance of our connectors along with UL and CSA recognition.
- 4 - Based on 2 housings blocked together.

IEC INFORMATION

| Connector Series | Configurations | | Creepage / Clearance per IEC 60950-1 | Material Group |
|------------------|--------------------|---------|--------------------------------------|----------------|
| PP180 | Single Pole | Unmated | 6.02 mm | IIla |
| | | Mated | 6.02 mm | |
| | Stacked Powerpole® | Unmated | 6.02 mm | |
| | | Mated | 6.02 mm | |

PROTECTION

Touch Safety with Wire Contacts

| | |
|-----------|------|
| IEC 60529 | IP10 |
|-----------|------|



| ATTRIBUTES | PP180 |
|---|---|
| AMP Rating AC/DC | 180 |
| Voltage Rating AC/DC (Steady State) | 500 V AC/DC (Operational) |
| Breaking Capacity - AMP Rating / Cycles | 180 Amp / 10 Cycles |
| Voltage Rating (Breaking Capacity) | 220 VDC |
| FINGER Safety - Mated Only | IEC 60529 - IP20 |
| Wire Size Tested | 70 mm ² |
| Contact Series Tested | 1382G2 |
| Climatic Testing (Cold, Heat & MFG) | IEC 60512 Test-11j, 11i & 11g |
| Cycle Life | IEC 60512 Test 9a - 5,000 Cycles |
| Mechanical Strength Impact | IEC 60512-5 @ 29.5 Inches-Dropped 8 times |
| Temperature Range | -20°C to 105°C -4°F to 221°F |

POWERPOLE® PP180 ACCESSORIES

Mounting Clamp

Mounting clamps can be used for fastening a block of Powerpole® 180 series housings to a panel. Connector blocks must be a complete square for the clamps to work properly. Fastening hardware not included.

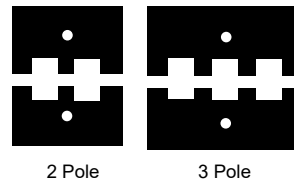
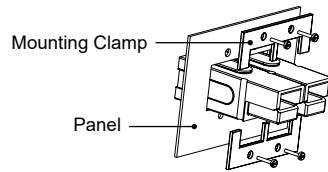

| Description | Part Numbers |
|------------------|--------------|
| Minimum Quantity | 20 sets of 2 |
| 2 Pole | 1465G1 |
| 3 Pole | 1465G2 |

Retaining Pins

Retaining pins are used to keep stacked Powerpole® 180 series housings from separating. Retaining pins are inserted in the circular opening between two housings stacked side by side. Dimension "B" is +/- .015 in or .38 mm.

| Description | Part Numbers | | Dimensions | | | |
|------------------|--------------|--------|---------------|-------------|----------|--------|
| | | | - A - inches | | - B - mm | |
| Minimum Quantity | 1,000 | 100 | | | | |
| 1 Block High | 111812P6 | 110G18 | 0.196 / 0.207 | 4.98 / 5.26 | 1.000 | 25.400 |
| 2 Block High | 111812P8 | 110G20 | 0.196 / 0.207 | 4.98 / 5.26 | 1.500 | 38.100 |

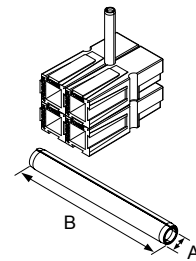

Reducing Bushings

Use with contact part number 1382-BK to allow a smaller wire to be used with the connector. Electrical capability is derated with smaller wire.

| Contact Barrel Size | | Wire Size | | Part Numbers | | | | Dimensions - ID - | |
|---------------------|-----------------|-----------|-----------------|--------------|---------|---------|------|-------------------|------|
| AWG | mm ² | AWG | mm ² | | | | | inches | mm |
| Minimum Quantity | | | | 1,500 | 1,000 | 500 | 100 | | |
| 1/0 | 53.5 | 1 | 42.4 | - | - | 5687-BK | 5687 | 0.39 | 9.91 |
| 1/0 | 53.5 | 2 | 33.6 | 5690-BK | - | - | 5690 | 0.34 | 8.64 |
| 1/0 | 53.5 | 4 | 21.2 | - | 5693-BK | - | 5693 | 0.27 | 6.86 |
| 1/0 | 53.5 | 6 | 13.3 | - | 5663-BK | - | 5663 | 0.22 | 5.59 |
| 1/0 | 53.5 | 10 to 8 | 5.3 to 8.4 | 5648-BK | - | - | 5648 | 0.19 | 4.83 |

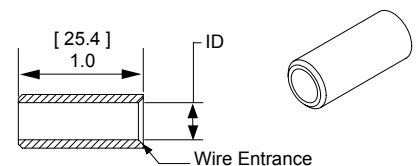

NOTE: Combination of a bushing and contact is not UL approved.

For environmentally sealed connector shells to hold Powerpole® 15 to 180 connectors, see SPEC Pak® product series on our website www.andersonpower.com



Powerpole®

Tooling Information - APP® Applicators are Mechanical Feed Style and do not Require an Air Feed Kit.

POWERPOLE® TOOLING

| Wire Size | | Loose Piece Part Number | | Loose Piece Contact Crimp Tools | | | | | | | |
|---|-----------------|-------------------------|----------------|---------------------------------|----|----------------------|---|---------|---|---------|------------------|
| AWG | mm ² | Tin Plating | Silver Plating | Hand Tool | OR | Pneumatic Bench Tool | + | Die | + | Locator | Number of Crimps |
| PP15 / 45 Flat Wiping Power & Ground | | | | | | | | | | | |
| 16 to 20 | 1.3 to 0.52 | N/A | 1332 | 1309G2 or 1309G8 | | | | | | | Single |
| 12 to 16 | 3.3 to 1.3 | N/A | 1331 | | | | | | | | |
| 16 to 20 | 1.3 to 0.52 | 262G1-LPBK | 262G2-LPBK | | | | | | | | |
| 16 to 20 | 1.3 to 0.52 | 269G2-LPBK | N/A | | | | | | | | |
| 12 to 16 | 3.3 to 1.3 | 261G1-LPBK | N/A | 1309G3 or 1309G8 | | N/A | | N/A | | | Single |
| 10 to 14 | 5.3 to 2.1 | 261G2-LPBK | 261G3-LPBK | | | | | | | | |
| 12 to 16 | 3.3 to 1.3 | 269G1-LPBK | N/A | | | | | | | | |
| 10 to 14 | 5.3 to 2.1 | 269G3-LPBK | N/A | 1309G6 or 1309G8 | | | | | | | |
| 10 to 14 | 5.3 to 2.1 | 200G1L-LPBK | 200G3L-LPBK | | | | | | | | |
| 10 to 14 | 5.3 to 2.1 | 201G1H-LPBK | N/A | | | | | | | | |
| 310 to 14 | 5.3 to 2.1 | 1830G1-LPBK | 1830G2-LPBK | | | | | | | | |
| PP75 | | | | | | | | | | | |
| 6 | 13.3 | N/A | 1307 | 1309G4 | | 1387G1 | | 1388G6 | | 1389G6 | Single |
| | | | 5900 | | | | | | | | |
| 8 | 8.4 | | 1875G1 | | | | | | | | |
| | | | 5952 | | | | | | | | |
| | | | 1875G2 | | | | | | | | |
| 10 to 12 | 5.3 to 3.3 | | 5953 | | | | | | | | |
| | | | 5915 | | | | | | | | |
| | | 1875G3 | | | | 1388G7 | | 1389G6 | | 1389G21 | |
| PP120 | | | | | | | | | | | |
| 1/0 | 53.5 | N/A | 1323G2 | 1368 Series | | 1387G1 | | 1388G3 | | 1389G4 | Single |
| 1 | 42.4 | | 1323G1 | | | | | | | | |
| 2 | 33.6 | | 1319 | | | | | | | | |
| 4 | 21.2 | | 1319G4 | | | | | | | | |
| 6 | 13.3 | | 1319G6 | | | | | | | | |
| PP180 | | | | | | | | | | | |
| 3/0 | 85 | N/A | 1328G2 | 1368 Series | | 1387G2 | | 1303G12 | | 1304G32 | Double |
| 2/0 | 53.5 | | 1328G1 | | | | | | | | |
| 1/0 | 53.5 | | 1382 | | | | | | | | |
| 1 | 42.4 | | 1347 | | | | | | | | |
| 2 | 33.6 | | 1383 | | | | | | | | |
| 4 | 21.1 | | 1384 | | | | | | | | |
| 6 | 13.3 | | 1348 | | | | | | | | |

Insertion / Extraction Tool for PP15/45 Contacts = 111038G2

NOTE: see website for the most current information.

| Wire Size | | Reeled Part Number | | Reeled Contact Crimp Tools | | |
|---|-----------------|--------------------|----------------|-----------------------------|---|--------------------------------|
| AWG | mm ² | Tin Plating | Silver Plating | APP [®] Applicator | + | APP [®] Press |
| PP15/45 Flat Wiping Power & Ground | | | | | | |
| 16 to 20 | 1.3 to 0.52 | 262G1 | 262G2 | TD0101 | | 115V = TE0101 230V = TE0102 |
| 16 to 20 | 1.3 to 0.52 | 269G2 | N/A | | | |
| 12 to 16 | 3.3 to 1.3 | 261G1 | N/A | | | |
| 10 to 14 | 5.3 to 2.1 | 261G2 | 261G3 | | | |
| 12 to 16 | 3.3 to 1.3 | 269G1 | N/A | | | |
| 10 to 14 | 5.3 to 2.1 | 269G3 | N/A | | | |
| 10 to 14 | 5.3 to 2.1 | 200G1L | 200G3L | TD0102 | | |
| 10 to 14 | 5.3 to 2.1 | 201G1H | N/A | | | |
| 10 to 14 | 5.3 to 2.1 | 1830G1 | 1830G2 | | | |

Multipole Family

Overview of SBS®, SB®, SBX® / SBO® Main Differentiating Features



SBS® - The “Storage Battery Safety” connector provides a compact connection with a touch safe interface. The newest series of the Multipole connector family continues to add new features and capabilities. Some models offer auxiliary capabilities or ground options.



SB® - Based on the original “Storage Battery” connector that pioneered flat wiping contact technology over a half century ago. Two to three positions in a genderless mechanically-keyed housing suitable for a wide array of power connection applications.



SBX® - The addition of auxiliary positions to the SB® created the “Storage Battery Auxiliary” connector. Up to 8 auxiliary positions allow expanded capabilities for the Multipole family by allowing intelligent power switching, monitoring of battery charge status, and other signal functions to be integrated into a single connector.



SBE® - By modifying the SBX® housing the “Storage Battery European” connector was created. The SBE® housings are molded from a chemical resistant PBT resin and the SBE® 320 features improved touch safety over the SBX® 350 design.



SBO® - Designed to meet the needs of connecting office equipment, the “Storage Battery Office” connector is molded out of durable PC like the original SB® but incorporates the auxiliary positions of the SBX® in a housing similar to the SBE® 80.



SB® SMART - Designed for applications where storage batteries intelligently interact with the system. Two primary power positions are combined with sixteen auxiliary power / signal positions. This allows one connection to be used to route high power lines, low power lines, and signal circuits.

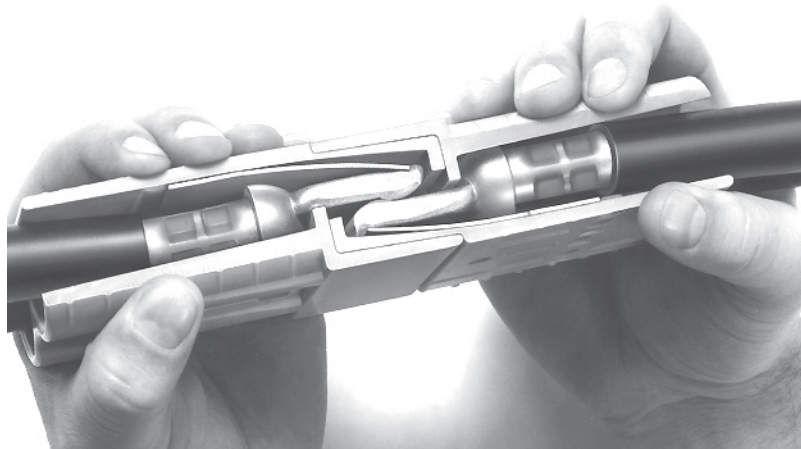

Hot Plugging AC or DC
 Contacts feature a sacrificial tip that allow high current circuit interrupt

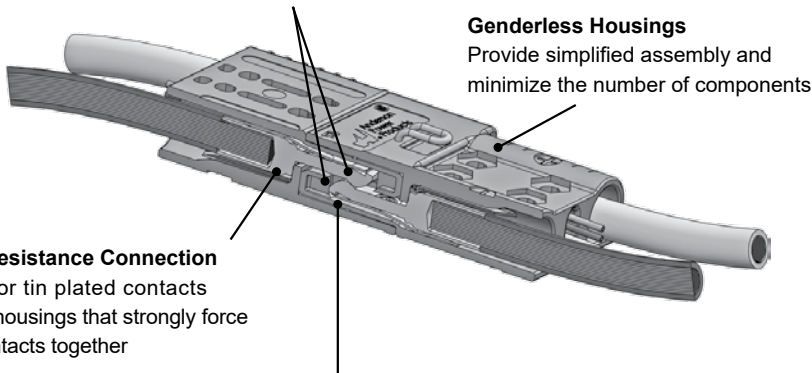

Genderless Housings
 Provide simplified assembly and minimize the number of components

Low Resistance Connection
 Silver or tin plated contacts inside housings that strongly force the contacts together

Self Securing Design
 Stainless steel springs create a robust force between the contacts that holds the connector in the mated condition

Keyed & Color Coded Housings
 Prevents accidental cross mating of circuits

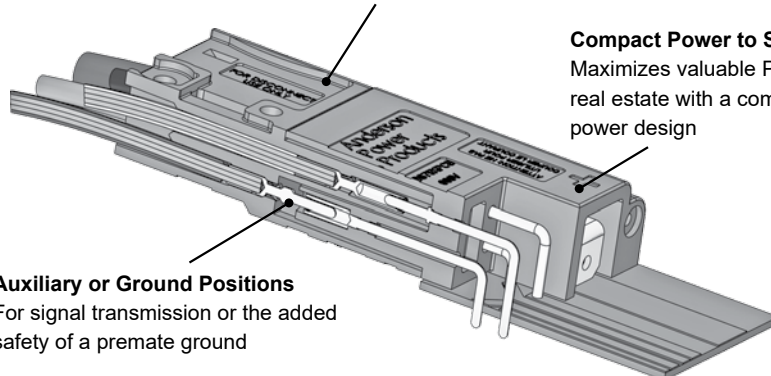

Compact Power to Size Ratio
 Maximizes valuable PCB edge real estate with a compact high power design

Auxiliary or Ground Positions
 For signal transmission or the added safety of a premate ground

MULTIPOLE FAMILY SELECTION GUIDE

| | SBS® Mini | SBS® | SB® | SBO® / SBE® / SBX® | SB® SMART |
|------------------------------|-------------------------|-----------------------|----------------------------|----------------------|-------------------------|
| Page Number | 63 | 67 | 78 | 102 | 124 |
| Amps Per Pole | Up to 52 | Up to 110 | Up to 500 | Up to 350 | Up to 230 |
| Volts (UL) Per Pole | 600 | 600 | 600 | 600 | 600 |
| Wire Gauge - AWG (mm²) | 20 to 10K (0.52 to 5.3) | 16 to 6 (1.3 to 13.3) | 16 to 350 mcm (1.3 to 185) | 6 to 300 (24 to 152) | 10 to 1/0 (5.3 to 53.5) |
| Number of Power Circuits | 2 | 2 to 3 | 2 to 3 | 2 | 2 |
| Number of Auxiliary Circuits | 0 | 4 | 0 | 8 | 16 |
| PCB Mount | | • | • | | |
| Busbar | | | • | | • |
| Panel Mount | | • | • | | |
| Hot Plug | • | • | • | • | • |
| Touch Safe | • | • | | • | |
| Mechanically Keyed | • | • | • | • | • |
| Handle | | • | • | • | |
| Air Supply System | | | | • | |
| Environmental Protection | | • | • | | |

Actual Size - Connector Half

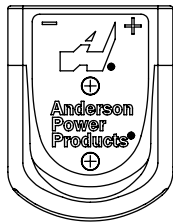

SBS® Mini

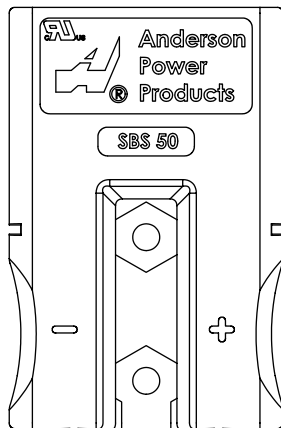

SBS® 50

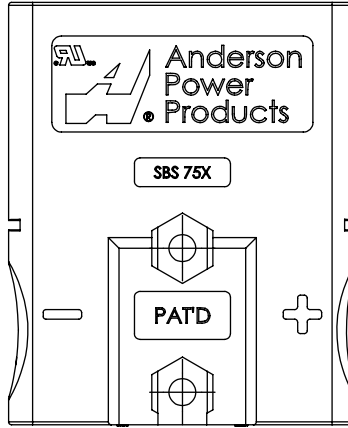

SBS® 75X

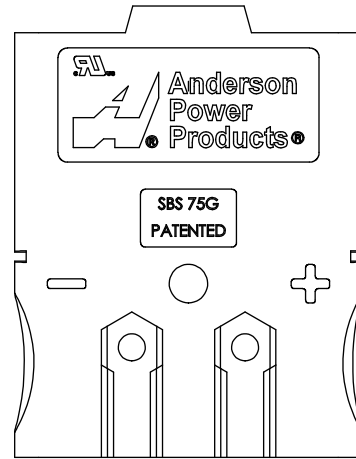

SBS® 75G

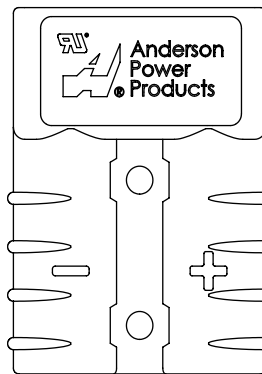

SB® 50

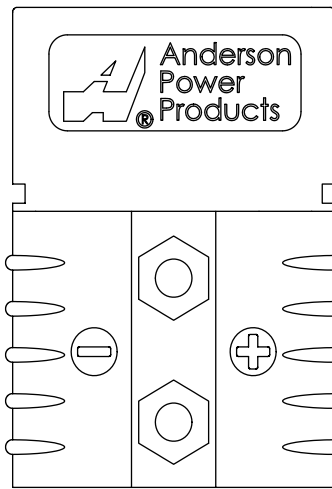

SB® 120

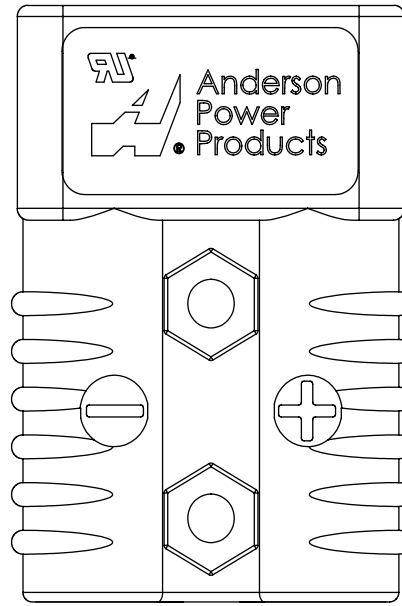

SB® 175 - 2 Pole

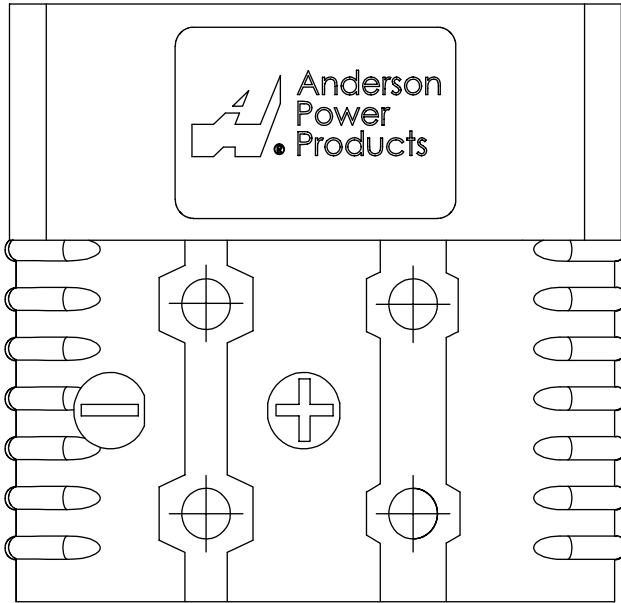

SB® 175 - 3 Pole

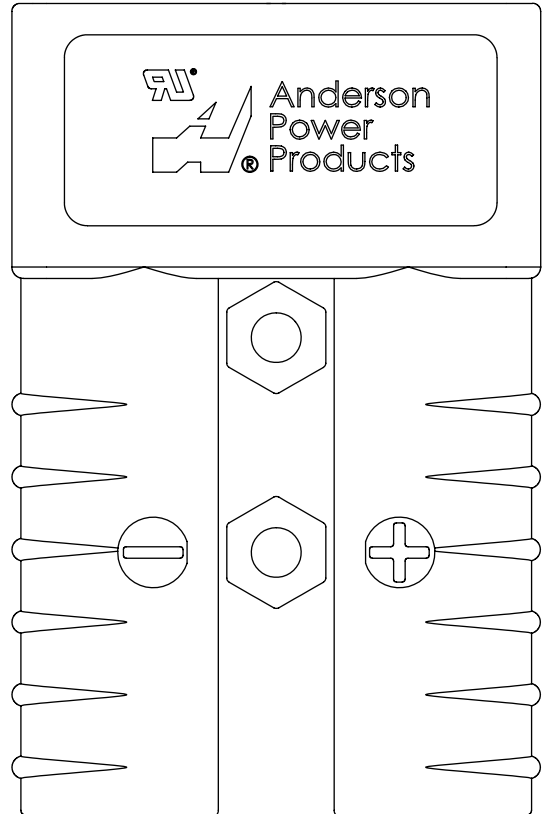

SB® 350

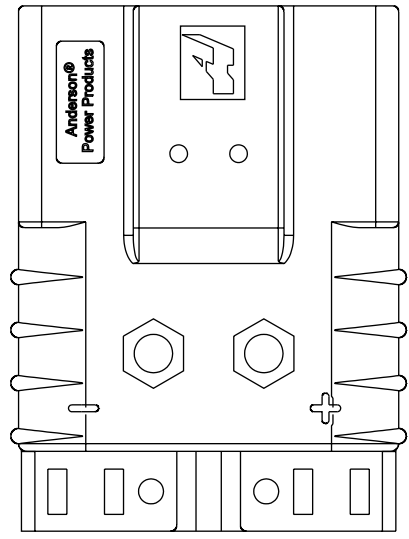

SBE® 80 / SBO® 60

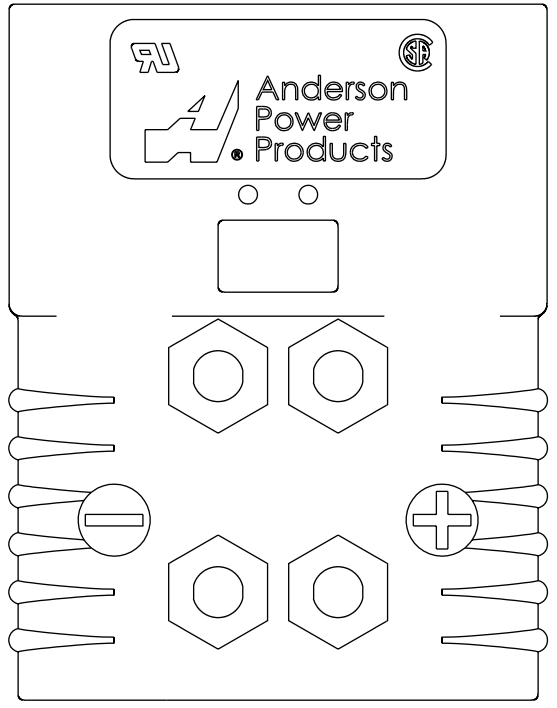

SBE® 160 / SBX® 175

MULTIPOLE FAMILY

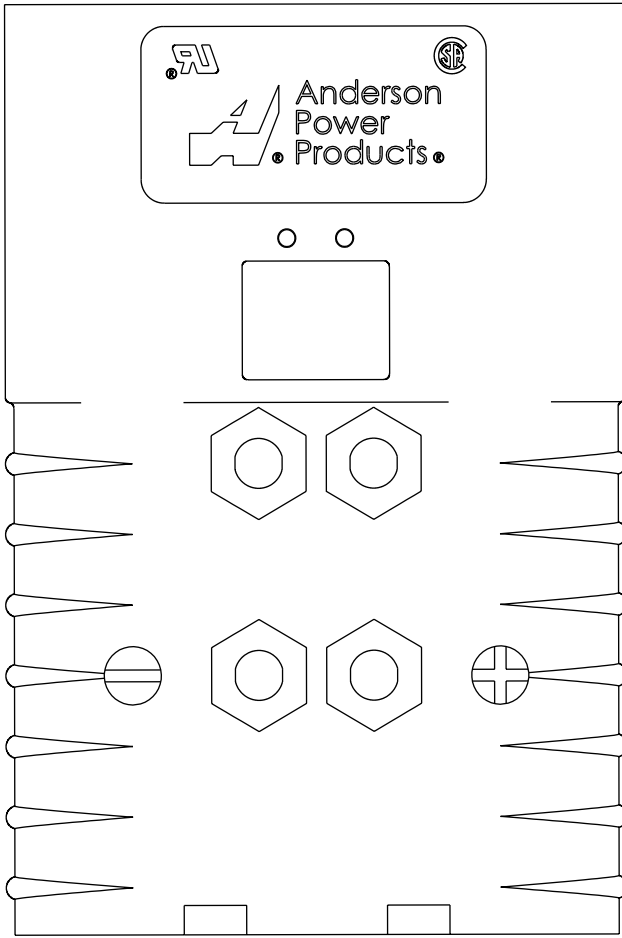

SBE® 320 / SBX® 350

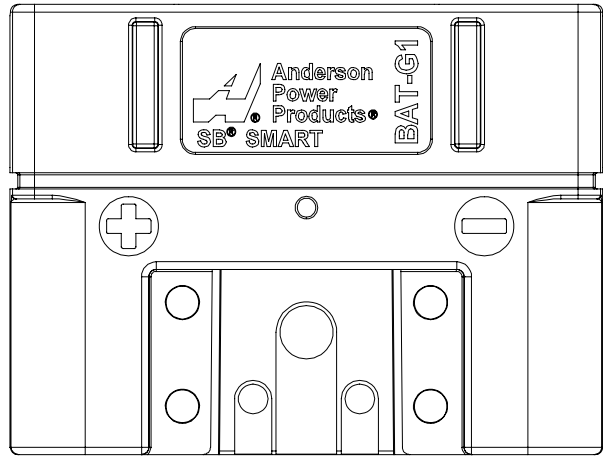

SB® Smart

Explanation of Mechanical Voltage Keys

Features molded into the mating interface of the connector housing prevent accidental cross mating of circuits. This molded feature mechanically keys the connection so that only housings with the same mating interface can be mated together.

Different mechanical keys can be easily recognized by the color of the housing. This color coding corresponds to a voltage that industrial trucks, batteries, and chargers have adopted as a standard to prevent incompatible voltages from cross mating.

The same mechanical keying and color coding that is so successful for industrial trucks, is also widely used in power electronics applications. UPS systems, power supplies, personal mobility, and alternative energy applications have all used this feature to ensure user safety.

NOTE: Some housings in the SB® 50, SB® 175, and SB® 350 series have different colored housings with a shared mechanical keying feature. Please see the specific data sheet for details.

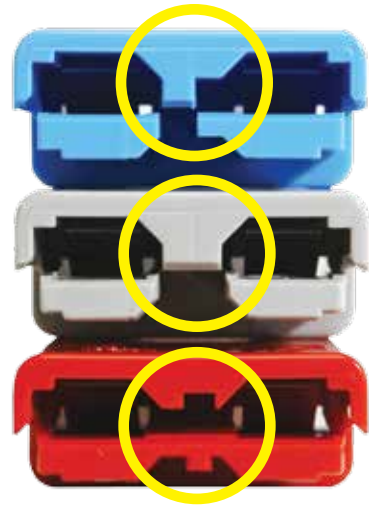

Recommended Voltage Key Color-Code

| Voltage | 12V | 18V | 24V | 36V | 48V | 72V | 80V | 96V | 120V | 144V |
|---------|--------|--------|-----|------|------|-------|-------|-------|--------|-------|
| Color | Yellow | Orange | Red | Gray | Blue | Green | Black | Brown | Purple | White |

SBS® Mini Connectors

Up to 52 amps



SBS® Mini Connector series is our smallest DC power connector in the SBS® group. The SBS® Mini securely holds two crimp and poke contacts with sacrificial tips to enable hot swap capabilities on DC circuits. The low resistance contacts accept 20 to 10 AWG (0.52 to 5.3 mm²) wires allowing up to 52 amps of UL rated performance per position.

- **Touch Safe Housing**
Minimizes potential contact with live circuits
- **Color-Coded Mechanical Key**
Prevents accidental mating of connectors operating at different voltage levels
- **Compact & Ergonomic Housing**
Is "user friendly" during connection and disconnection of the system
- **UL Hot Plug Rated to 45 Amps @ 72 Volts**
Good for applications where the ability to interrupt circuits is required

SBS® MINI

SBS® MINI ORDERING INFORMATION

SBS® Mini Housing

The smallest SBS® connector has 2 finger proof positions in a polycarbonate housing with an ergonomic grip. The housing securely holds crimp and poke contacts from the popular Powerpole® 15/45 series connectors.

| Description | Part Numbers |
|------------------|--------------|
| Minimum Quantity | 100 |
| Red | B02265G1 |
| Black | B02265G2 |
| Blue | B02265G3 |
| Gray | B02265G4 |

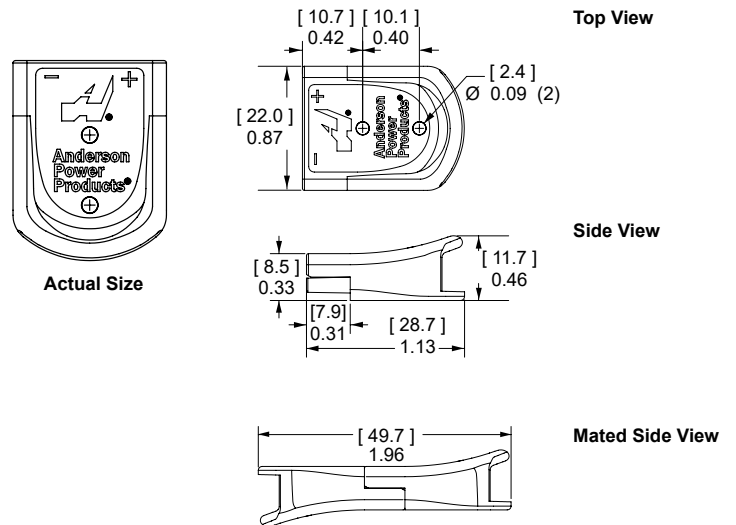

SBS® Mini Cable Clamp Assembly Kit

Insert Cable Clamp into middle position of housing, securing with pins and using a wire tie to secure wires. Kit includes clamp and 2 pins only. Wire ties sold separately.

| Description | Part Numbers | in. | mm |
|----------------------|--------------|-------------|-------------|
| Minimum Quantity | 1,000 | | |
| Gray Clamp Kit, Gray | B02597G4 | 1.15 x 0.34 | 29.1 x 8.60 |
| Cable Wire Tie | H1835P11 | 4 x 0.10 | 100 x 2.50 |



PP15/45 Tin Plated Power Contacts

Offer cost effective performance up to 200 mating cycles. See specifications and temperature charts for amperage ratings by wire size.

| Barrel | AWG | mm ² | Loose Piece Part Numbers | Reeled Part Numbers | Dimensions - A - | |
|------------------|-------------|-----------------|--------------------------|---------------------|------------------|------|
| | | | | | inches | mm |
| Minimum Quantity | | | 200 | 5,000 | | |
| Open | 20 to 16 | 0.52 to 1.3 | 262G1-LPBK | 262G1 | 0.16 | 4.06 |
| Open | 16 to 12 | 1.3 to 3.3 | 261G1-LPBK | 261G1 | 0.18 | 4.57 |
| Open | 14 to 10 K* | 2.1 to 5.3 | 261G2-LPBK | 261G2 | 0.20 | 5.08 |

K* - For 10 AWG class K stranded wire or smaller.

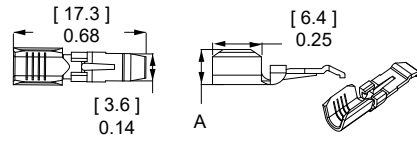

PP15/45 Silver Plated Power Contacts

Maximize performance by offering up to 1,500 mating cycles. Recommended for circuit interrupt or hot plug applications. See specifications and temperature charts for amperage ratings by wire size. Only closed barrel contacts are suitable for soldering.

| Barrel | AWG | mm ² | Loose Piece Part Numbers | Reeled Part Numbers | Dimensions | | | | |
|------------------|-------------|-----------------|--------------------------|---------------------|------------|------|--------|------|------|
| | | | | | - A - | | - B - | | |
| | | | | | inches | mm | inches | mm | |
| Minimum Quantity | | | 5,000 | 200 | 5,000 | | | | |
| Closed | 20 to 16 | 0.52 to 1.3 | 1332-BK | 1332 | - | 0.12 | 3.05 | 0.07 | 1.78 |
| Closed | 16 to 12 | 1.3 to 3.3 | 1331-BK | 1331 | - | 0.15 | 3.81 | 0.10 | 2.54 |
| Open | 20 to 16 | 0.52 to 1.3 | - | 262G2-LPBK | 262G2 | 0.16 | 4.06 | - | - |
| Open | 14 to 10 K* | 2.1 to 5.3 | - | 261G3-LPBK | 261G3 | 0.20 | 5.08 | - | - |

K* - For 10 AWG class K stranded wire or smaller.

Open Barrel Contact

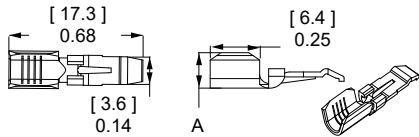

Closed Barrel Contact

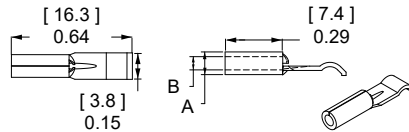

SBS® MINI

SBS® Mini - Tooling Information

| Wire Size | | Open Closed Barrel | Loose Piece Part Numbers | | Hand Tool | OR | Reeled Part Numbers | | Reeled Contact Crimp Tools | |
|-------------|-----------------|--------------------------|--------------------------|----------------|------------------------|----|---------------------|----------------|----------------------------|--------------------------------|
| AWG | mm ² | | Tin Plating | Silver Plating | | | Tin Plating | Silver Plating | APP® Applicator | APP® Press |
| 20 to 16 | 0.52 to 1.3 | Closed | N/A | 1332 / 1332-BK | 1309G2 or 1309G8 | | N/A | N/A | N/A | N/A |
| 16 to 12 | 1.3 to 3.3 | Closed | N/A | 1331 / 1331-BK | | | | | | |
| 20 to 16 | 0.52 to 1.3 | Open | 262G1-LPBK | 262G2-LPBK | 1309G3 or 1309G8 | | 262G1 | 262G2 | TD0101 | 115V = TE0101 230V = TE0102 |
| 16 to 12 | 1.3 to 3.3 | Open | 261G1-LPBK | N/A | | | 261G1 | N/A | | |
| 14 to 10 K* | 2.1 to 5.3 | Open | 261G2-LPBK | 261G3-LPBK | | | 261G2 | 261G3 | | |

Insertion / Extraction Tool 111038G2

K* - For 10 AWG class K stranded wire or smaller.

Need More Than 2 Positions?



See the stackable Powerpole® 15 to 45 connectors. These single position connectors use the same contact system as SBS® Mini and can be stacked together to create custom multiple position configurations.

SBS® Mini CONNECTOR TEMPERATURE CHARTS - Temperature rise charts are based on a 25°C ambient temperature.

Current - Temperature Derating per IEC 60512-5-2 Test 5B

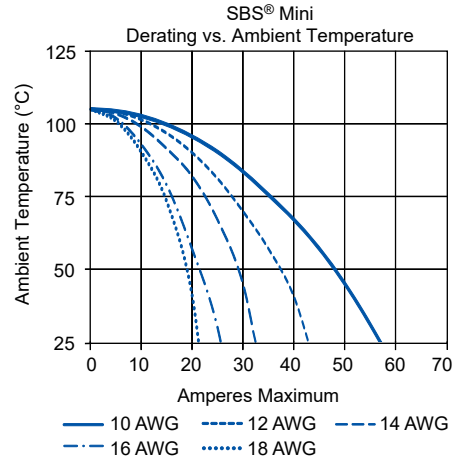
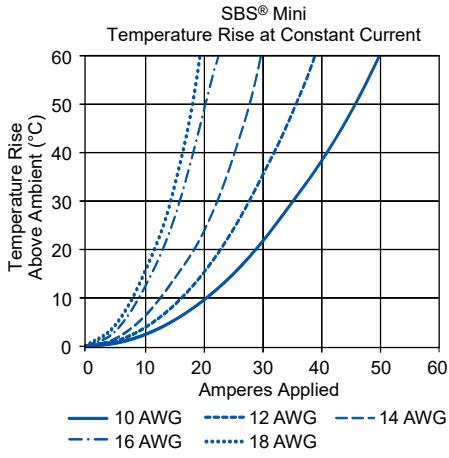

SBS® MINI

SBS® MINI SPECIFICATIONS

ELECTRICAL

| Current Rating Amperes ¹ | UL 1977 | CSA |
|-------------------------------------|---------|-----|
| 10 AWG | 52 | 35 |
| 12 AWG | 41 | 28 |
| 14 AWG | 31 | 23 |
| 16 AWG | 24 | 16 |
| 18 AWG | 20 | 15 |

Voltage Rating AC/DC

| | |
|---------|-----|
| UL 1977 | 600 |
|---------|-----|

Dielectric Withstanding Voltage

| | |
|----------|-------|
| Volts AC | 2,200 |
|----------|-------|

Avg. Mated Contact Resistance Milliohms ²

| | |
|----------------------------------|-------|
| Wire Contact with 5/8" of 16 AWG | 0.875 |
| Wire Contact with 5/8" of 12 AWG | 0.600 |
| Wire Contact with 5/8" of 10 AWG | 0.525 |

UL Hot Plug Current Rating Amperes ³

| | |
|----------------------|-----|
| 250 Cycles at 72V DC | 45A |
|----------------------|-----|

MATERIALS

Housing

| | |
|--------------------------|-----------------|
| Plastic Resin | Polycarbonate |
| Contact Retention Spring | Stainless Steel |

Housing Flammability Rating

| | |
|-----------|-----------------------------|
| UL94 | V-0 |
| Glow Wire | 960°C (GWFI) / 800°C (GWIT) |

Contact

| | |
|---------|---------------|
| Base | Copper Alloy |
| Plating | Tin or Silver |

Contact Termination Methods

| | |
|--------------------|---------------|
| Crimp ³ | Wire Contacts |
| Hand Solder | 1331 & 1332 |

MECHANICAL

| Wire Size Range | AWG | mm ² |
|-----------------|----------|-----------------|
| | 20 to 10 | 0.52 to 5.3 |

| Max. Wire Insulation Diameter | in. | mm |
|-------------------------------|-------|------|
| | 0.183 | 4.65 |

| Operating Temperature | °F | °C |
|-----------------------|-------------|--------------|
| | -4° to 221° | -20° to 105° |

| Mating Cycles No Load by Plating | Silver (Ag) | Tin (Sn) |
|----------------------------------|-------------|----------|
| 10 to 12 AWG | 1,500 | 200 |
| 14 to 18 AWG | 8,000 | 200 |

| Avg. Mating / Unmating Force ⁴ | Lbf. | N |
|---|----------|----------|
| 10 AWG | 10 to 11 | 45 to 49 |
| 12 to 18 AWG | 4 to 7 | 17 to 31 |

| Min. Contact / Spring Retention Force | Lbf. | N |
|---------------------------------------|------|----|
| | 20 | 90 |



NOTE 1: See IEC 60664-1 for working voltage.

1 - Based on: 105°C rated or better cable of the largest size. Properly calibrated APP® recommended tooling, and a 25°C ambient temperature. UL rating not to exceed the maximum operating temperature. CSA rating below a 30°C temperature rise.

2 - Use APP® recommended tooling only. Alternate tools may adversely affect the performance of our connectors along with UL and CSA recognition.

3 - Based on 261G3 with 10 AWG wire.

4 - Contact customer service for contacts with a higher disconnect force.

IEC INFORMATION

| Connector Series | Configurations | Creepage / Clearance per IEC 60950-1 | Material Group |
|------------------|----------------|--------------------------------------|----------------|
| SBS® Mini | Unmated | 1.47 mm | IIla |
| | Mated | 2.40 mm | |

PROTECTION

Touch Safety

| | |
|-------------------|------|
| UL 1977 Sec. 10.2 | Pass |
| IEC 60950 | Pass |
| IEC 60529 | IP20 |



SBS® Connectors

Up to 110 amps



SBS® 75G



SBS® 50



SBS® 75X

The patented SBS® connector family is designed to provide high power in a compact ergonomic housing with protection against accidental contact with live circuits. This is of particular importance in applications where DC voltages exceed 30 volts and can be health threatening.

Wire-to-wire and wire-to-board configurations both provide power contacts rated up to 110 amps. The SBS® 75X offers up to 4 mate-last break-first auxiliary power / signal contacts rated up to 20 amps. The SBS® 75G features a third first-mate last-break ground or power contact. All contact positions are rated for circuit interruption (hot plugging).

- **Touch Safe Interface**

*Can safely be used in through panel applications
Minimizes potential contact with live circuits per IEC 60950*

- **Wire-to-Wire and Wire-to-Board Configurations**

Allows one connector to meet multiple needs

- **Ground or Auxiliary Positions Integrated into the One Piece Housing**

Meets all connection requirements in one compact connector housing

SBS® 50 & 75

SBS® ORDERING INFORMATION

SBS® 50 Standard Housings

Polycarbonate housings feature 2 positions all finger proof. Genderless design mates with itself. Mechanical keys are color coded.

| Description | Part Numbers | |
|------------------|--------------|----------|
| Minimum Quantity | 500 | 50 |
| Red | SBS50RED-BK | SBS50RED |
| Gray | SBS50GRA-BK | SBS50GRA |
| Blue | SBS50BLU-BK | SBS50BLU |
| Black | SBS50BLK-BK | SBS50BLK |
| Brown | SBS50BRN-BK | SBS50BRN |
| White | SBS50WHT-BK | SBS50WHT |

SBS® 50 Chemical Resistant (CR) Housings

Same features as the standard housings, but molded out of a chemical resistant PBT / PC blend. Suitable for use to -40°C.

| Description | Part Numbers | |
|------------------|--------------|-----------|
| Minimum Quantity | 500 | 50 |
| Gray | PSBS50GRA-BK | PSBS50GRA |
| Blue | PSBS50BLU-BK | PSBS50BLU |
| Green | PSBS50GRN-BK | PSBS50GRN |
| Black | PSBS50BLK-BK | PSBS50BLK |
| Red | PSBS50RED-BK | - |
| Brown | PSBS50BRN-BK | - |

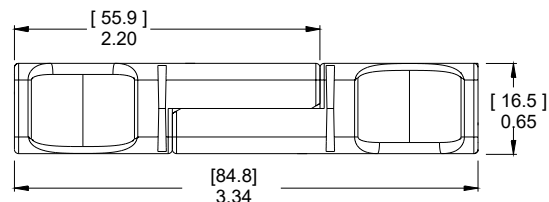
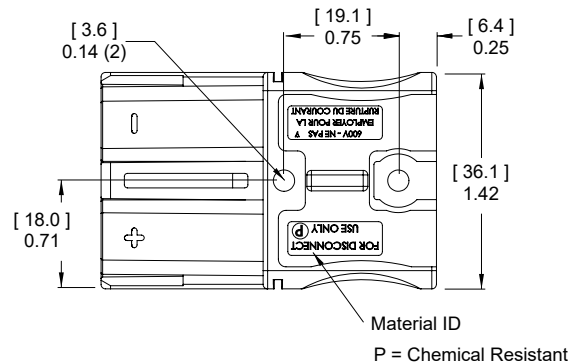

SBS® 75X Standard Housings

Polycarbonate housings feature 4 auxiliary and 2 primary positions all finger proof. Genderless design mates with itself, or the PCB connector. Mechanical keys are color coded. Inquire with Customer Service about other color offerings.

| Description | Part Numbers | |
|------------------|--------------|-----------|
| Minimum Quantity | 250 | 50 |
| Black | SBS75XBLK-BK | SBS75XBLK |
| Brown | SBS75XBRN-BK | SBS75XBRN |

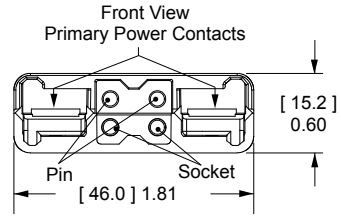

SBS® 75X Chemical Resistant (CR) Housings

Same features as the standard housings, but molded out of a chemical resistant PBT/ PC blend. Suitable for use to -40°C. Inquire with Customer Service about other color offerings.

| Description | Part Numbers | |
|------------------|---------------|------------|
| Minimum Quantity | 250 | 50 |
| Green | PSBS75XGRN-BK | - |
| Black | PSBS75XBLK-BK | PSBS75XBLK |

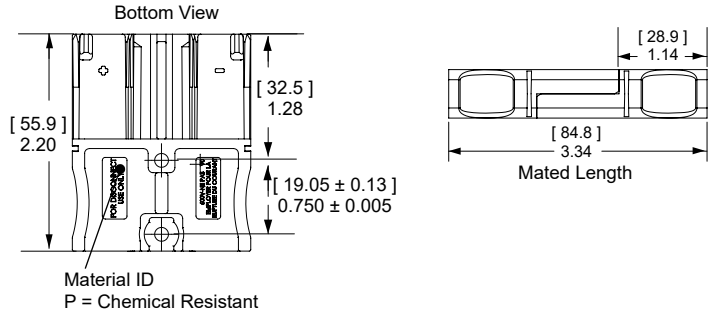

SBS® 75X Assembled PCB Connector

Fully assembled PCB connector is designed to mate with SBS® 75X Wire connector. All positions are preloaded with contacts including standard mating length auxiliary positions. Press fit board locks help secure the connector to the PCB before and after soldering. Choose between tin or silver contacts.

| Description | Part Numbers | |
|------------------------|-----------------|----------------|
| Minimum Quantity | 250 | 100 |
| Black - Tin Contact | - | SBS75XPRBLK-BK |
| Black - Silver Contact | SBS75XPRSBLK-BK | - |

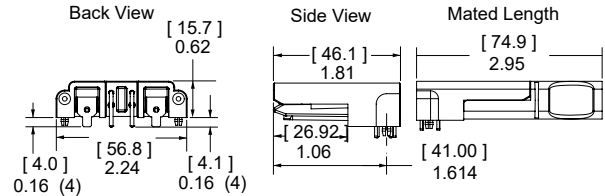

See PCB connector drawing on website for further detail.

SBS® 75G Wire Housings

Polycarbonate housings feature three finger proof positions. The center position can be used for pre-mate power or ground. Genderless design mates with itself, or the PCB connector. Mechanical keys are color-coded. Inquire with customer service for chemical resistant housings.

| Description | Part Numbers | |
|------------------|--------------|-----------|
| Minimum Quantity | 250 | 50 |
| Blue | SBS75GBLU-BK | SBS75GBLU |
| Black | SBS75GBLK-BK | SBS75GBLK |
| Brown | SBS75GBRN-BK | SBS75GBRN |
| White | SBS75GWHT-BK | SBS75GWHT |

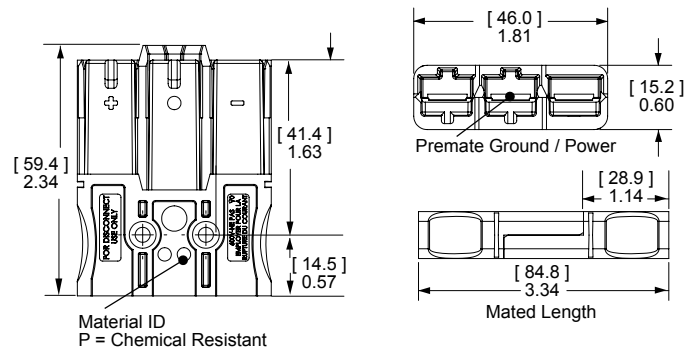

SBS® 75G Assembled PCB Connector

Fully assembled PCB connector is designed to mate with SBS® 75G Wire connector. Has press fit board locks to help secure the connector to the PCB before and after soldering.

| Description | Part Number |
|------------------|----------------|
| Minimum Quantity | 100 |
| Black | SBS75GPRBLK-BK |

See PCB connector drawing on website for further detail.

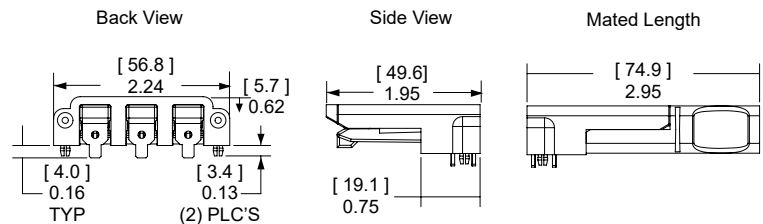

SBS® Silver Plated Primary Power Wire Contacts

Use two silver plated contacts per housing for the best electrical performance and durability up to 10,000 mating cycles. Standard contacts are for use in all primary power positions for SBS® 50, 75X, & 75G wire housings. See reducing bushings in accessory section for smaller wires.

| Type | AWG | mm ² | Loose Piece Part Numbers | | Dimensions - A - | |
|------------------|----------|-----------------|--------------------------|----------|------------------|------|
| | | | inches | mm | inches | mm |
| Minimum Quantity | | | 1,000 | 100 | | |
| Standard | 6 | 16 | 1339G2-BK | 1339G2 * | 0.22 | 5.60 |
| Standard | 8 | 10 | 1339G5-BK | 1339G5 * | 0.19 | 4.70 |
| Standard | 12 to 10 | 2.5 to 6 | 1339G3-BK | 1339G3 * | 0.14 | 3.50 |

* Are sold as pairs. 2 contacts ship for every 1 ordered.

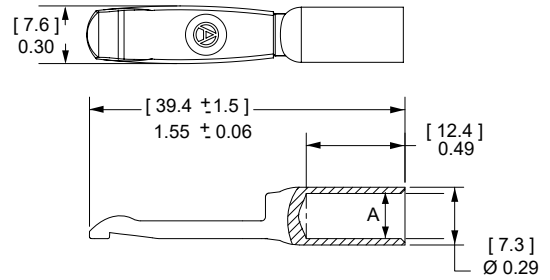

SBS® 75G Silver Plated Pre-Mate Wire Contacts

Pre-Mate contacts used for power or ground are for the center Pre-Mate position on the SBS®75G wire housings. See reducing bushings in accessory section for smaller wires.

| Type | AWG | mm ² | Loose Piece Part Numbers | | Dimensions - A - | |
|------------------|----------|-----------------|--------------------------|--------|------------------|------|
| | | | inches | mm | inches | mm |
| Minimum Quantity | | | 500 | 50 | | |
| Pre-Mate | 6 | 16 | 1340G1-BK | 1340G1 | 0.22 | 5.60 |
| Pre-Mate | 8 | 10 | 1340G2-BK | 1340G2 | 0.19 | 4.70 |
| Pre-Mate | 12 to 10 | 2.5 to 6 | 1340G3-BK | 1340G3 | 0.14 | 3.50 |

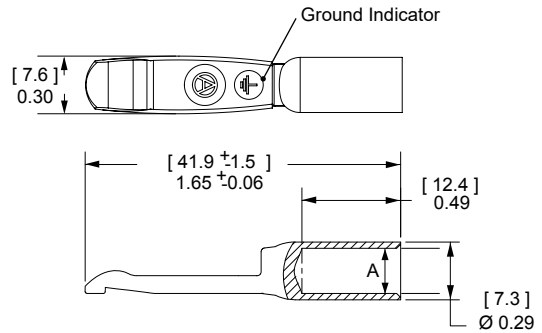

Pin Contacts for SBS® 75X Auxiliary

Gold plated contacts are available in 3 lengths to allow sequencing of circuits.

| Description | AWG | mm ² | Part Numbers | |
|------------------------|----------|-----------------|--------------|-----------------|
| Minimum Quantity | | | 500 | 50 |
| Standard Length 7.7 mm | 12 | 2.5 | PM16P12S30 | PM16P12S30-50 |
| | 16 to 14 | 1.0 to 1.5 | PM16P1416S30 | PM16P1416S30-50 |
| | 20 to 16 | 0.75 to 1.0 | PM16P1620S30 | PM16P1620S30-50 |
| | 24 to 20 | 0.50 to 0.75 | PM16P2024S30 | PM16P2024S30-50 |
| Pre-Mate 9.3 mm | 12 | 2.5 | PM16P12A30 | - |
| | 16 to 14 | 1.0 to 1.5 | PM16P1416A30 | - |
| | 20 to 16 | 0.75 to 1.0 | PM16P1620A30 | - |
| | 24 to 20 | 0.50 to 0.75 | PM16P2024A30 | - |
| Post-Mate 6.4 mm | 12 | 2.5 | PM16P12C30 | - |
| | 16 to 14 | 1.0 to 1.5 | PM16P1416C30 | - |
| | 20 to 16 | 0.75 to 1.0 | PM16P1620C30 | - |
| | 24 to 20 | 0.50 to 0.75 | PM16P2024C30 | - |

| Auxiliary Pin Contact Lengths | - L - | | - L1 - | |
|-------------------------------|-------|------|--------|-----|
| | in. | mm | in. | mm |
| Standard Length 7.7 mm | 0.77 | 19.6 | 0.30 | 7.7 |
| Pre-Mate 9.3 mm | 0.83 | 21.2 | 0.37 | 9.3 |
| Post-Mate 6.4 mm | 0.72 | 18.3 | 0.25 | 6.4 |

See drawings on website for further details

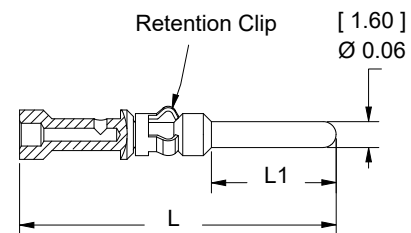

Socket Contacts for SBS® 75X Auxiliary

Selectively gold plated contacts offer low resistance and durability up to 10,000 mating cycles.

| Description | AWG | mm ² | Part Numbers | | Auxiliary Socket Contacts Crimp Barrel ID | | |
|------------------|----------|-----------------|--------------|-----------------|---|------|-----|
| Minimum Quantity | | | 500 | 50 | | | |
| Socket Contact | 12 | 2.5 | PM16S12S32 | PM16S12S32-50 | Wire Gauge | in. | mm. |
| | 16 to 14 | 1.0 to 1.5 | PM16S1416S32 | PM16S1416S32-50 | 24 to 20 | 0.04 | 1.1 |
| | 20 to 16 | 0.75 to 1.0 | PM16S1620S32 | PM16S1620S32-50 | 20 to 16 | 0.07 | 1.7 |
| | 24 to 20 | 0.50 to 0.75 | PM16S2024S32 | PM16S2024S32-50 | 16 to 14 | 0.08 | 2.1 |
| | | | | | 12 | 0.10 | 2.6 |

See drawings on website for further details

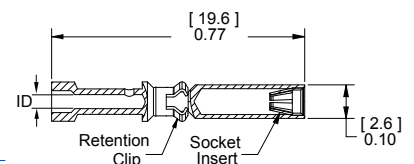

SBS® CONNECTOR TEMPERATURE CHARTS - Temperature rise charts are based on a 25°C ambient temperature.

Current - Temperature Derating per IEC 60512-5-2 Test 5B

SBS® 50 & 75

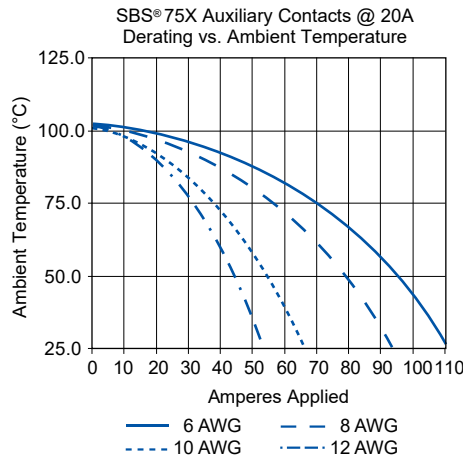
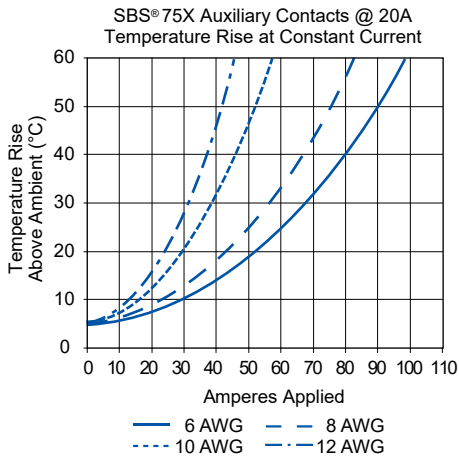
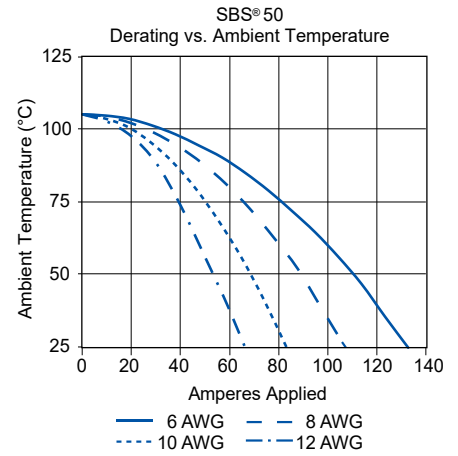
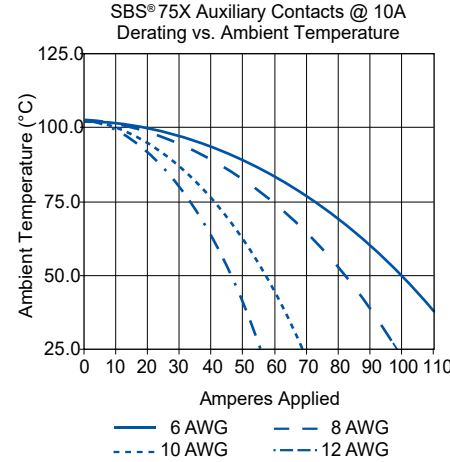
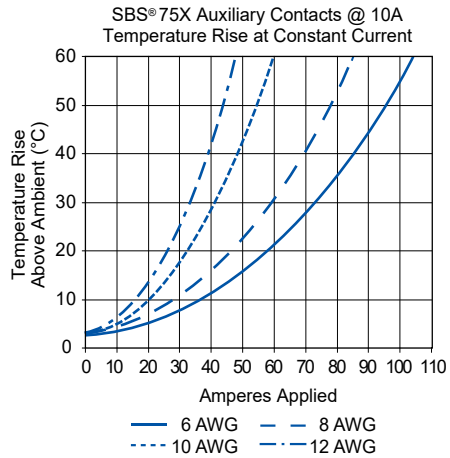
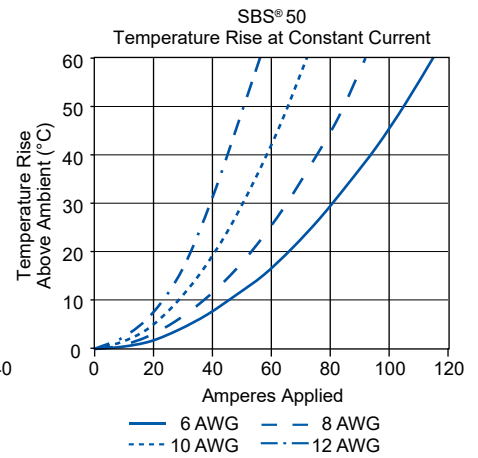
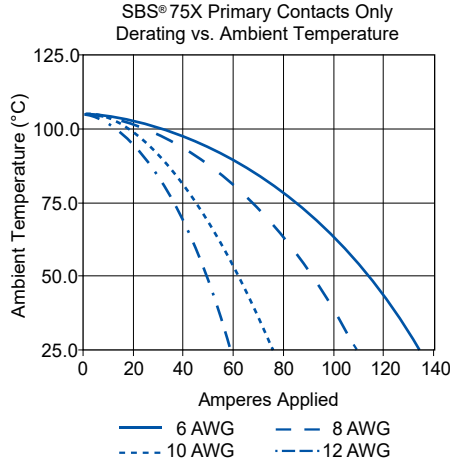
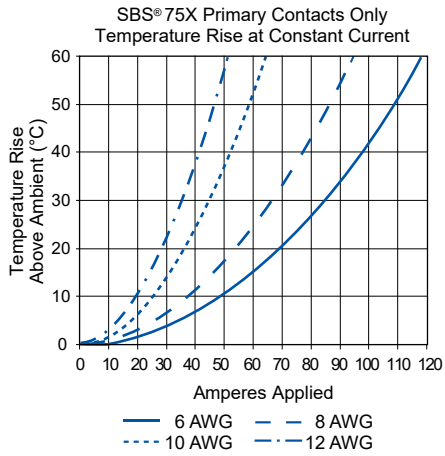

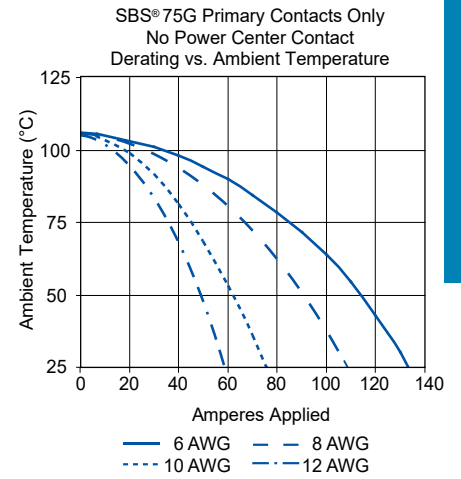
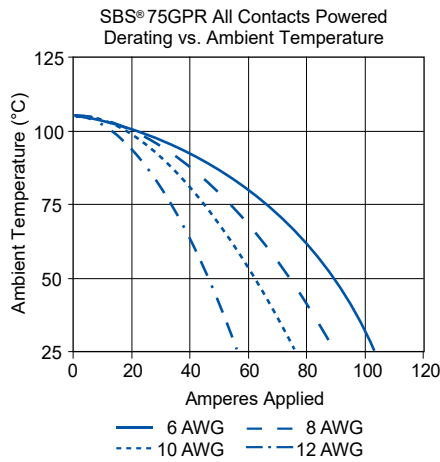
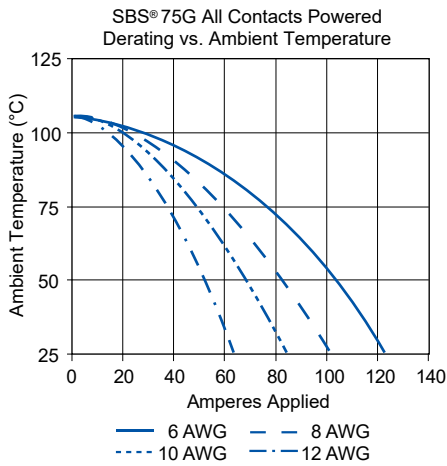
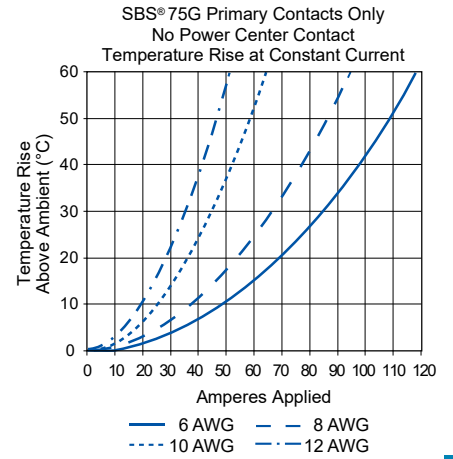
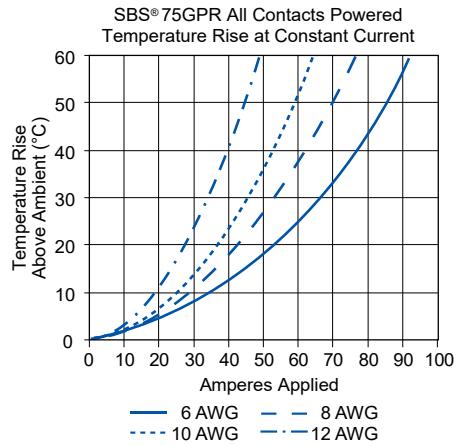
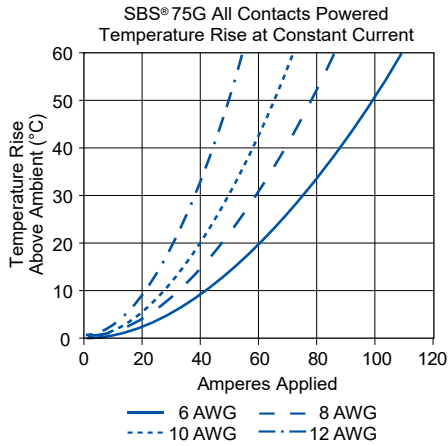

SBS® CONNECTOR SPECIFICATIONS

ELECTRICAL

| Current Rating Amperes ¹ | UL 1977 | CSA / TUV |
|-------------------------------------|---------|-----------|
| Primary Power (6 AWG) | 110 | 75 |
| Auxiliary (12 AWG) | 20 | 10 |

Voltage Rating AC/DC

| | |
|---------|-----|
| UL 1977 | 600 |
|---------|-----|

Dielectric Withstanding Voltage

| | |
|----------|-------|
| Volts AC | 2,200 |
|----------|-------|

Avg. Mated Contact Resistance Milliohms ¹

| | |
|--------------------------------------|-------|
| Power & Ground: 1 1/4" of 6 AWG wire | 0.200 |
| Auxiliary: Wire & PCB | 3.000 |

UL Hot Plug Current Rating Amperes - 250 cycles at 120V DC

| | |
|----------------------|-----|
| Wire & PCB Power | 50A |
| Wire & PCB Auxiliary | 5A |

UL Ground Short Time Current Test - SBS® 75G Wire & PCB

| | |
|-------------------------|-----------|
| 1530 Amps, (6 AWG) Wire | 6 Seconds |
|-------------------------|-----------|

MATERIALS

Housing

| | |
|--------------------------|---------------------------|
| Standard Plastic Resin | Polycarbonate |
| Chem. Resistant Resin | Polycarbonate / PBT Blend |
| Contact Retention Spring | Stainless Steel |

Housing Flammability Rating

| | |
|---------------------|-----------------------------|
| UL94 | V-0 |
| Glow Wire - SBS® 50 | 825°C (GWFI) / 800°C (GWIT) |
| - SBS® 75G | 960°C (GWFI) / 800°C (GWIT) |
| - SBS® 75X | 960°C (GWFI) / 800°C (GWIT) |

Wire Power & Ground Contact

Silver Plated Copper Alloy

PCB Power & Ground Contact

Tin Plated Copper Alloy

SBS® 75X Auxiliary Contacts

| | |
|----------------|---------------------------------|
| Pin | Copper Alloy, Au Over Ni |
| Socket | BeCu, Au over Ni |
| Socket Body | Copper Alloy, Sn Bright Over Ni |
| Retention Clip | Stainless Steel |

PCB Press Fit Retainers

Brass - Tin Plated

Contact Termination Methods

| | |
|--------------------|-----------------------|
| Crimp ³ | Wire Contacts |
| Hand Solder | Wire and PCB Contacts |
| Solder Dip | PCB Contacts |
| Wave Solder | PCB Contacts |

SBS® 50 & 75



• Auxiliary contacts are available for SBS® 75X only.

• SBS® 75X and SBS® 75G PCB connectors are designed to mate only with the wire connector of the same series.

NOTE 1: See IEC 60664-1 for working voltage.

NOTE 2: Amp ratings are stated per position and based on all positions being fully loaded.

1 - Based on: 105°C rated or better cable of the largest size. Properly calibrated APP® recommended tooling, and a 25°C ambient temperature.

UL rating not to exceed the maximum operating temperature. CSA rating below a 30°C temperature rise.

2 - Limited by the thermal properties of the connector plastic housing.

3 - Use APP® recommended tooling only. Alternate tools may adversely affect the performance of our connectors along with UL and CSA recognition.

| MECHANICAL | | | |
|---|----------------------|-----------------------|------------------|
| Wire Size Range | AWG | mm² | |
| Power Contacts (with bushings) | 16 to 6 | 1.3 to 13.3 | |
| Auxiliary Contacts | 24 to 12 | 0.25 to 3.3 | |
| Max. Wire Insulation Diameter | in. | mm | |
| SBS® 75G Power & Ground | 0.380 | 9.652 | |
| SBS® 50 & SBS® 75X Power Contacts | 0.410 | 10.414 | |
| SBS® 75X Auxiliary Contacts | 0.140 | 3.600 | |
| Operating Temperature ² | °F | °C | |
| Standard | -4° to 221° | -20° to 105° | |
| Chemical Resistant | -40 to 221° | -40° to 105° | |
| Mating Cycles No Load by Plating | Silver (Ag) | Tin (Sn) | Gold (Au) |
| Power & Ground Contacts Wire | 10,000 | | |
| Power & Ground Contacts PCB | | 1,500 | |
| Auxiliary Contacts | | | 10,000 |
| Avg. Mating / Unmating Force | Lbf. | N | |
| SBS® 75X and SBS® 75G Wire-to-Wire | 16 | 70 | |
| SBS® 50 Wire-to-Wire | 8 | 36 | |
| SBS® 75X and SBS® 75G Wire-to-PCB | 8 | 36 | |
| Min. Contact / Spring Retention Force | Lbf. | N | |
| Power, Standard Housing | 50 | 222 | |
| Power, Chemical Resistant Housing | 30 | 133 | |
| Auxiliary Standard Housing | 15 | 67 | |
| Auxiliary Chemical Resistant Housing | 10 | 44 | |
| PCB Specifications | | | |
| Mounting Style | Plated Through Hole | | |
| Max PCB Thickness - in. (mm) | 0.093 (2.4) | | |
| Recommended Traces Power & Ground | 6 AWG Cross Section | | |
| Recommended Traces Auxiliary | 12 AWG Cross Section | | |
| Min. Creepage / Clearance Distance PCB | in. | mm | |
| Power to Auxiliary Creepage SBS® 75X | 0.41 | 10.4 | |
| Power to Auxiliary Clearance SBS® 75X | 0.24 | 6.1 | |
| Power to Ground Creepage SBS® 75G | 0.35 | 8.9 | |
| Power to Ground Clearance SBS® 75G | 0.26 | 6.7 | |
| Auxiliary Creepage SBS® 75X | 0.12 | 3.0 | |
| Auxiliary Clearance SBS® 75X | 0.12 | 3.0 | |

IEC INFORMATION

| Connector Series | Configurations | Creepage / Clearance per IEC 60950-1 | Material Group |
|------------------|----------------|--------------------------------------|----------------|
| SBS® 75G | Unmated | 3.33 mm | IIIa |
| | Mated | 4.64 mm | |

| Connector Series | Configurations | Creepage / Clearance per IEC 60950-1 | Material Group |
|------------------|----------------|--------------------------------------|----------------|
| SBS® 75X | Unmated | 3.33 mm | IIIa |
| | Mated | 4.64 mm | |

| Connector Series | Configurations | Creepage / Clearance per IEC 60950-1 | Material Group |
|------------------|----------------|--------------------------------------|----------------|
| SBS® 50 | Unmated | 3.85 mm | IIIa |
| | Mated | 4.64 mm | |

| PROTECTION | |
|---|------|
| Touch Safety with Wire Contacts & PCB Mating Interface | |
| IEC 60950 | Pass |
| IEC 60529 | IP20 |

| ATTRIBUTES | SBS® 50 |
|---|---|
| AMP Rating AC/DC - Power Only | 6 AWG - 75A, 8 AWG 65A - 10 AWG - 45A, 12 AWG - 35A |
| Voltage Rating AC/DC (Steady State) | 600 AC / DC (Operational) |
| Auxiliary Contacts | NA |
| Breaking Capacity - AMP Rating / Cycles - Power Contacts | 6 AWG - 50A, 120 VDC / 250 Cycles |
| Breaking Capacity - Auxiliary Contacts | NA |
| Voltage Rating (Breaking Capacity) | 120 VDC |
| Finger Safety - Mated only | IEC 60529 - IP20 |
| Wire Size Tested | Power 12, 10, 8, 6 AWG |
| Contact Series Tested | 1339G2, 1339G3, 1339G5 |
| Auxiliary contacts | NA |
| Climatic Testing (Cold, Heat & MFG) | IEC 60512 Test - 11j, 11i & 11g |
| Cycle Life | IEC 60512 Test 9a - 5,000 Cycles |
| Mechanical Strength Impact | IEC 60512-5 @ 29.5 Inches - Dropped 8 Times |
| Temperature Range | -20°C to 105°C -4°F to 221°F |

| ATTRIBUTES | SBS® 75X |
|--|---|
| AMP Rating AC/DC - Power only | 6 AWG - 75A, 8 AWG 65A - 10 AWG - 45A, 12 AWG - 35A |
| Power Contacts and Auxiliary Contacts (Auxiliary contacts at 15A) | 6 AWG - 75A, 8 AWG 60A - 10 AWG - 35A, 12 AWG - 30A |
| Auxiliary Contacts | 12 AWG - 15A |
| Voltage Rating AC/DC (Steady State) | 600V AC/DC (Operational) |
| Auxiliary Contacts | 12 AWG - 15A |
| Breaking Capacity - AMP Rating / Cycles - Power Contacts | 6 AWG - 50A, 120 VDC / 250 Cycles |
| Breaking Capacity - Auxiliary Contacts | 12 AWG - 5A, 120 VDC / 250 Cycles |
| Voltage Rating (Breaking Capacity) | 120 VDC |
| Finger Safety - Mated Only | IEC 60529 - IP20 |
| Wire Size Tested | Power 12 AWG, 10 AWG, 8 AWG, 6AWG / Signal 12 AWG |
| Contact Series Tested | Power 1339G2, 1339G3, 1339G5 |
| Auxiliary Contacts | PM16P12S30, PM16S12S32 |
| Climatic Testing (Cold, Heat & MFG) | IEC 60512 Test - 11j, 11i & 11g, |
| Cycle Life | IEC 60512 Test 9a - 5,000 Cycles |
| Mechanical Strength Impact | IEC 60512-5 @ 29.5 Inches - Dropped 8 Times |
| Temperature Range | -20°C to 105°C -4°F to 221°F |

| Attributes | SBS® 75G |
|---|--|
| AMP Rating AC/DC - Power Only | 110 |
| Power Contacts and Auxiliary contacts (Auxiliary contacts at 15A) | NA |
| Auxiliary Contacts | NA |
| Voltage Rating AC/DC (Steady State) | 600V AC/DC (Operational) |
| Auxiliary Contacts | NA |
| Breaking Capacity - AMP Rating / Cycles - Power Contacts | 6 AWG - 50A, 120 VDC / 250 Cycles |
| Breaking Capacity - Auxiliary Contacts | NA |
| Voltage Rating (Breaking Capacity) | 120 VDC |
| Finger Safety - Mated Only | IEC 60529 - IP10, IP20 |
| Wire Size Tested | 6 AWG |
| Contact Series Tested | Power 1339G2, 1339G3, 1339G5 / Ground 1340G1 |
| Auxiliary Contacts | NA |
| Climatic Testing (Cold, Heat & MFG) | IEC 60512 Test-11j, 11i & 11g |
| Cycle Life | IEC 60512 Test 9a - 1,500 Cycles |
| Mechanical Strength Impact | IEC 60512-5 @ 29.5 Inches- Dropped 8 Times |
| Temperature Range | -20°C to 105°C -4°F to 221°F |

| Attributes | SBS® 75G and GPR (PCB) |
|---|----------------------------------|
| AMP Rating AC/DC - Power Only | 110 |
| Power Contacts and Auxiliary contacts (Auxiliary contacts at 15A) | NA |
| Auxiliary Contacts | NA |
| Voltage Rating AC/DC (Steady State) | 600V AC / DC (Operational) |
| Auxiliary Contacts | NA |
| Breaking Capacity - AMP Rating / Cycles - Power Contacts | 6 AWG - 50A,120 VDC / 250 Cycles |
| Breaking Capacity - Auxiliary Contacts | NA |
| Voltage Rating (Breaking Capacity) | 120 VDC |
| Finger Safety - Mated Only | IEC 60529 - IP20 |
| Wire Size Tested | 6 AWG |
| Contact Series Tested | Power B02075P1 / Ground B02114P1 |
| Auxiliary Contacts | NA |
| Climatic Testing (Cold, Heat & MFG) | IEC 60512 Test - 11j, 11i & 11g |
| Cycle Life | IEC 60512 Test 9a - 1,500 Cycles |
| Mechanical Strength Impact | NA |
| Temperature Range | -20°C to 105°C -4°F to 221°F |



SBS® ACCESSORIES

Mounting Clamp for SBS® 50 *

Mounting clamps can be used for fastening a SBS® 50 series housings to a panel. Fastening hardware not included.

| Description | Part Number |
|---------------------------------|--------------|
| Minimum Quantity | 20 sets of 2 |
| Panel Mount Bracket for SBS® 50 | 1466G1 |

* Torque value 5 (in - lbs) / 0.56 (Nm)

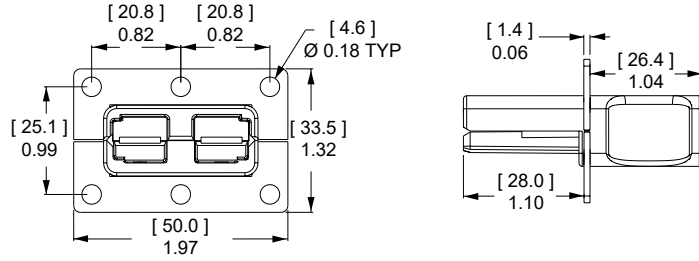

T-Handles for SBS® 50 and SBS® 75X *

The "T" handles make mating and unmating the connector easier. The non-conductive polycarbonate or chemical resistant PBT red plastic material is strong and safe.

(2) Self tapping screws are used to secure the handle to the connector housing.

| Description | Part Numbers | |
|--------------------------------------|--------------|----------------|
| Minimum Quantity | 1,000 | 50 |
| Red "T" Handle + Hardware Bag | - | SBS50-HDL-RED |
| Hardware Bag (2 Screws) | - | 104G17 |
| Red "T" Handle Only | 113899P1 | - |
| PBT SBS50 "T" Handle, Red | 113899P2 | - |
| #8 x 5/8" Screw (Order 2 Per Handle) | H1120P55 | - |
| PBT SBS® 50 Handle, Red + Hardware | - | PSBS50-HDL-RED |

* Torque value 10 (in - lbs) / 1.13 (Nm)

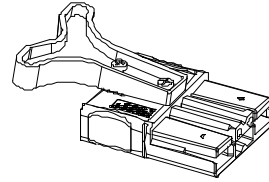

"A" Frame Handle for SBS® 50 and SBS® 75X *

Handle makes mating and unmating the connector easier. The non-conductive gray plastic material is strong and safe. Machine screws and locknuts included.

| Description | Part Number |
|----------------------------|-------------|
| Minimum Quantity | 200 |
| Gray "A" Handle & Hardware | 997G1 |

* Torque value 12 (in - lbs) / 1.4 (Nm)

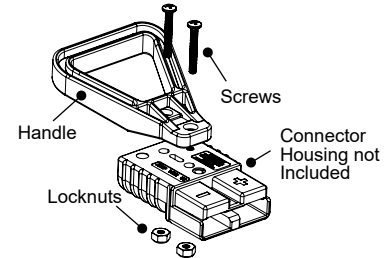

T-Handle for SBS® 75G *

The "T" handle makes mating and unmating the connector easier. The non-conductive red plastic material is strong and safe. (2) Machine screws and lock nuts.

| Description | Part Number |
|-------------------------------|--------------|
| Minimum Quantity | 50 |
| Red "T" Handle + Hardware Bag | SBS75GHDLRED |

* Torque value 10 (in - lbs) / 1.13 (Nm)

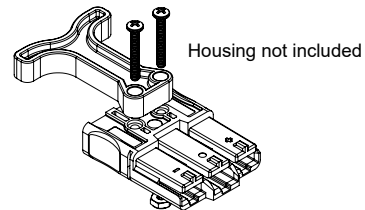

Dust Cover SBS® 50

Prevents dust and dirt from entering the mating interface of the connector when unmated. *NOTE: Not a Hermetic Seal.*

| Description | Part Numbers | |
|------------------------------------|--------------|-------|
| Minimum Quantity | 500 | 50 |
| Dust Cover with Lanyard Strap, Red | 113890P1 | 134G1 |

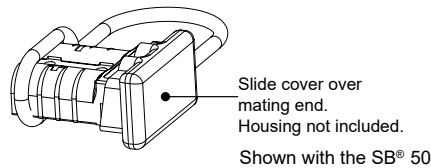

Cable Clamps for SBS® 50 *

Durable metal cable clamps securely hold cables to prevent accidental strain or pulls from dislodging wire or contacts from the housing. Cable clamps are recommended for solder terminated wires.

| Description | Cable Size | | Part Numbers | |
|---------------------------------------|------------------------|--------------------------------|--------------|-------|
| | AWG or (Inches O.D.) * | mm ² or (mm O.D.) * | | |
| Minimum Quantity | | | 500 | 50 |
| Self Attaching for Discrete Conductor | 8 to 6 | 10 | 990-BK | 990 |
| Self Attaching for Discrete Conductor | 12 to 10 | 2.5 to 4 | 990G2-BK | 990G2 |
| Bolt On for Discrete Conductor | 12 to 6 | 2.5 to 10 | 990G1-BK | 990G1 |
| Bolt On for Bundled Conductor | 0.320 to 0.450 | 4.27 to 11.43 | 5905-BK | 5905 |

* Torque value 12 (in - lbs) / 1.4 (Nm) *NOTE: For assembly of clamp to housing only*

The given wire O.D. information is an estimate. Cable clamps should be evaluated for performance with the actual wire to be used.

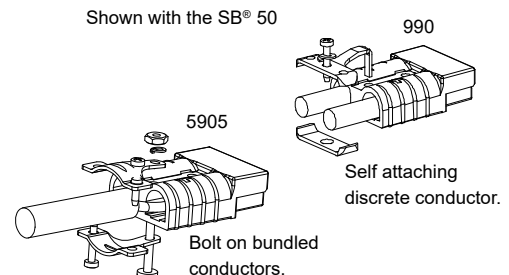

Cable Clamps for SBS® 75X with Integral Handle *

Rugged chemical resistant PBT/ PC plastic cable clamps securely hold cables to prevent accidental strain or pulls from dislodging wire or contacts from the housing. Cable clamps are recommended for solder terminated wires.

| Description | Cable Size AWG or (Inches O.D.) ** | mm ² or (mm O.D.) ** | Part Numbers | |
|----------------------------------|------------------------------------|---------------------------------|----------------|-------------|
| Minimum Quantity | | | 100 | 25 |
| Large Wire Clamp Kit w/ Hardware | 12 to 6 (0.39 to 0.60) | 4 to 10 (9.9 to 15.2) | PSBS75XCLP1-BK | PSBS75XCLP1 |
| Small Wire Clamp Kit w/ Hardware | 12 to 6 (0.34 to 0.55) | 4 to 10 (8.6 to 14.0) | PSBS75XCLP2-BK | PSBS75XCLP2 |

* Torque value 5 (in - lbs) / 0.56 (Nm).

** The given wire O.D. information is an estimate. Cable clamps should be evaluated for performance with the actual wire to be used.

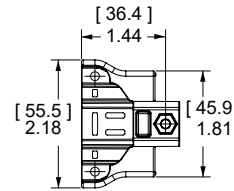
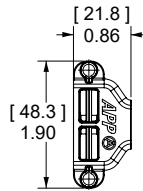

Clamp hardware requires phillips or flat blade screwdriver to assemble.

Reducing Bushings

Use with contact part number 1339G2-BK or 1340G1-BK to allow a smaller wire to be used with the connector. Electrical capability is derated with smaller wire.

| Contact Barrel Size AWG mm ² | Wire Size AWG mm ² | Part Numbers | Dimensions | | | |
|--|----------------------------------|-----------------|---------------------|-----------|-------------------------|--|
| | | | - ID - inches mm | | - Length - inches mm | |
| Minimum Quantity | | 3,000 1,000 100 | | | | |
| 6 13.3 | 8 8.4 | - 5912-BK 5912 | 0.18 4.6 | 0.45 11.4 | | |
| 6 13.3 | 12 to 10 3.3 to 5.3 | 5910-BK - 5910 | 0.14 3.6 | 0.47 11.9 | | |
| 6 13.3 | 16 to 14 1.3 to 2.1 | 5913-BK - 5913 | 0.09 2.3 | 0.47 11.9 | | |

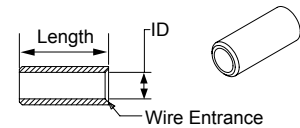

See drawings on website for further detail

SBS® TOOLING INFORMATION

| Wire Size | | Power / Ground Contacts | | | | | | | | |
|-----------|-----------------|---------------------------|----------------------|---|--------|---|---------|------------------|----|-----------|
| AWG | mm ² | Power Contact Part Number | Pneumatic Bench Tool | + | Die | + | Locator | Number of Crimps | OR | Hand Tool |
| 6 | 13.3 | 1339G2 | 1387G1 | | 1388G6 | | 1389G9 | Single | | 1309G4 |
| 8 | 8.4 | 1339G5 | | | 1388G7 | | | | | |
| 10 to 12 | 5.3 to 3.3 | 1339G3 | | | 1388G6 | | 1389G20 | | | |
| 6 | 13.3 | 1340G1 | | | 1388G7 | | | | | |
| 8 | 8.4 | 1340G2 | | | | | | | | |
| 10 to 12 | 5.3 to 3.3 | 1340G3 | | | | | | | | |

| Wire Size | | SBS® 75X Auxiliary Contacts | | | | | | | | |
|-----------|-----------------|-------------------------------|------------------------------------|----|---------------------------------|----|-----------------|------------------|---|------------------------------|
| AWG | mm ² | Auxiliary Contact Part Number | APP® Hand Tool w/ Integral Locator | OR | Mil Std. Hand Tool* M22520/1-01 | OR | Pneumatic Tool* | Number of Crimps | + | Locator for: TM0001 & TP0001 |
| 12 to 24 | 2.5 to 0.25 | All Crimp Pins | PM1000G1 | | TM0001 | | TP0001 | Single | | TL0001 |
| | | All Crimp Sockets | | | | | | | | TL0002 |

SBS® 75X Auxiliary Contact Insertion Tool: PM1002G1

SBS® 75X Auxiliary Contact Extraction Tool: PM1003G1

SBS® 75X Auxiliary Contact Insertion Inspection Tool: PM1003GX

SBS® 75X Insertion Tool: 111038G3

* TP0001 and TM0001 tools require locators TL0001 for Pins and TL0002 for Sockets.

NOTE: See website for the most current information.

The auxiliary contacts used with wire sizes 16 to 24 AWG cannot be properly inserted without the insertion tool. Properly installed auxiliary contact of all wire gauges cannot be removed from the housing without the extraction tool. It is highly recommended that inspection tool be used to ensure the auxiliary contacts are seated properly.

SB[®] 50 Connectors

Up to 120 amps



Based off the design pioneered by Anderson™ in 1953, the two pole SB[®] connectors set the standard for DC power distribution and battery connections. SB[®] 50 connectors feature a one piece plastic housing using stainless steel springs to hold low resistance contacts in place. Wires sizes from 16 to 6 AWG (1.5 to 13.3 mm²) are held in the smallest of the SB[®] series housings.

- **Low Resistance Silver or Tin Plated Copper Contacts**
Allows UL rated currents up to 120 amps
- **UL Rated for Hot Plugging up to 50 Amps**
Great for battery or other applications where the ability to interrupt circuits is required
- **Wire, PCB, and Busbar Contacts**
Allows one connection system to meet multiple needs

SB[®] 50

SB[®] 50 ORDERING INFORMATION

SB[®] 50 Standard Housings

The smallest SB[®] housings work with wire contacts up to 6 AWG (10 mm²) as well as PCB, and busbar contacts. Genderless design mates with itself. Mechanical keys are color-coded.

| Description | Part Numbers | |
|------------------|--------------|-------|
| Minimum Quantity | 500 | 100 |
| Yellow | 992G5-BK | 992G5 |
| Orange | 992G7-BK | 992G7 |
| Red | 992G1-BK | 992G1 |
| Gray | 992-BK | 992 |
| Blue | 992G4-BK | 992G4 |
| Green | 992G6-BK | 992G6 |
| Black | 992G2-BK | 992G2 |

NOTE: SB[®] 50 Black and Gray housings have the same keying features and can be intermated.

SB[®] 50 Chemical Resistant Housings

Same features as the Standard SB[®] 50 but molded in a chemical resistant PBT/PC blend. Suitable for use to -40°C.

| Description | Part Numbers | |
|------------------|--------------|--------|
| Minimum Quantity | 500 | 100 |
| Red | P992G1-BK | P992G1 |
| Gray | P992-BK | P992 |
| Black | P992G2-BK | P992G2 |

NOTE: SB[®] 50 Black and Gray housings have the same keying features and can be intermated.

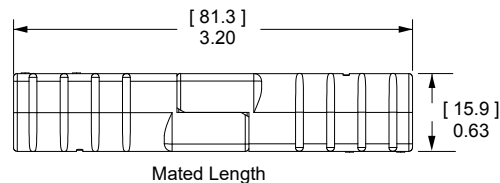
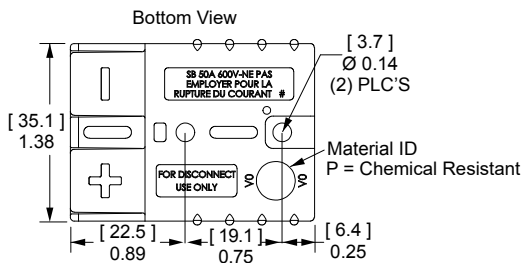

SB® 50 Silver Plated Wire Contacts

Use two silver plated contacts per housing for the best electrical performance and durability up to 10,000 mating cycles. See reducing bushings in accessory section for smaller wires.

| AWG | mm ² | Mating Force | Loose Piece Part Numbers | | Dimensions - A - | |
|-------------------------|-----------------|--------------|--------------------------|--------------|------------------|------|
| | | | Part Numbers | Part Numbers | inches | mm |
| Minimum Quantity | | | | | | |
| 6 | 13.3 | Low | 1307-BK | 1307 | 0.22 | 5.59 |
| 6 | 13.3 | High | 5900-BK | 5900 | 0.22 | 5.59 |
| 8 | 8.4 | High | 5952-BK | 5952 | 0.19 | 4.83 |
| 12 to 10 | 3.3 to 5.3 | Low | 5953-BK | 5953 | 0.14 | 3.56 |
| 12 to 10 | 3.3 to 5.3 | High | 5915-BK | 5915 | 0.14 | 3.56 |

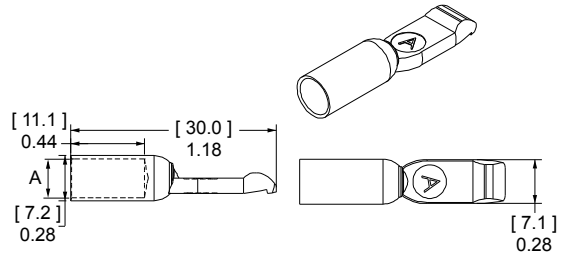

SB® 50 Silver Plated Busbar Contacts

Use 2 busbar contacts per housing to provide a quick disconnect input or output busbar connection. Busbar contacts are for mating with wire contacts only. Part number 75BBS includes lock nuts. Locknuts must be ordered separately for B01915P1.

| Type | Thread | Mating Force | Loose Piece Part Numbers | |
|-------------------------|----------|--------------|--------------------------|--------|
| Minimum Quantity | | | | |
| Busbar | 10 to 24 | High | B01915P1 | 75BBS |
| Lock Nut | 10 to 24 | - | H1216P8 | 110G54 |

NOTE: Has not been tested by UL.

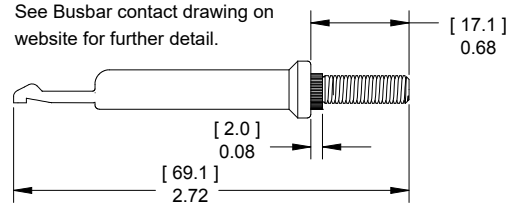

55A Right Angle Standard Powerclaw PCB Contacts

Standard Powerclaw contacts are for use inside a SB® 50 housing and provide a color-coded right angle connection to the PCB.

| Description | Loose Piece Part Numbers | |
|-------------------------|--------------------------|---------|
| Minimum Quantity | 500 | 100 |
| Tin Plated | PC5930T-BK | PC5930T |
| Silver Plated | PC5930S-BK | PC5930S |

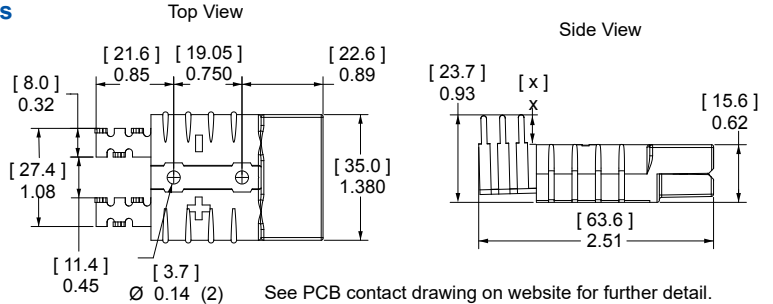

55A Right Angle Mini Powerclaw PCB Contacts

Right angle Mini Powerclaw contacts can be used on the PCB edge without a SB® 50 housing on the PCB side. A self polarizing design only allow SB® 50 wire housings to mate to PCB contacts one way.

| Description | Loose Piece Part Numbers | |
|-------------------------|--------------------------|---------|
| Minimum Quantity | 1,000 | 100 |
| Tin Plated | PC5934T-BK | PC5934T |
| Silver Plated | PC5934S-BK | PC5934S |

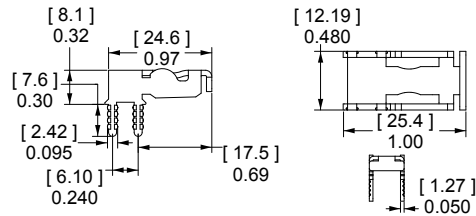

55A Vertical Mini Powerclaw PCB Contacts

Vertical Mini Powerclaw contacts save space by not requiring a SB® 50 housing on the PCB side. The guide housing is required for to provide a polarized connection. (See SB® 50 accessories).

| Description | Loose Piece Part Numbers | |
|-------------------------|--------------------------|---------|
| Minimum Quantity | 1,500 | 100 |
| Tin Plated | PC5933T-BK | PC5933T |
| Silver Plated | PC5933S-BK | PC5933S |

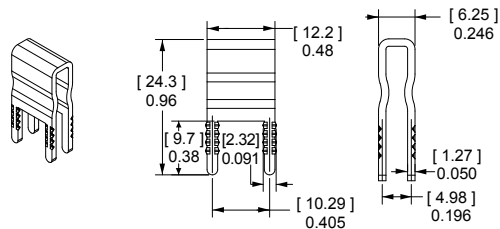

SB® 50 CONNECTOR TEMPERATURE CHARTS - Temperature rise charts are based on a 25°C ambient temperature.

Current - Temperature Derating per IEC 60512-5-2 Test 5B

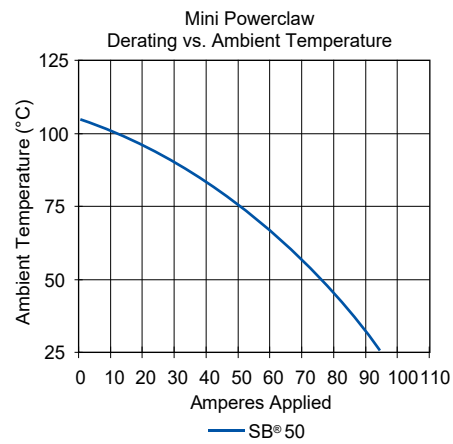
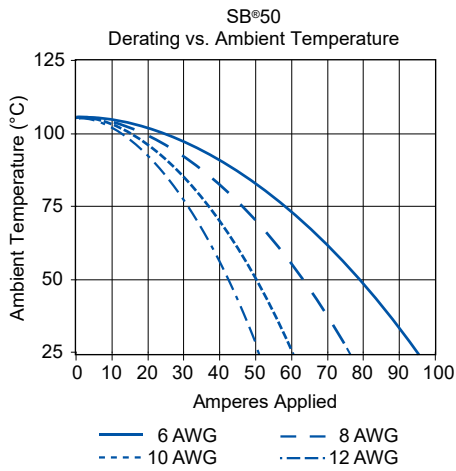
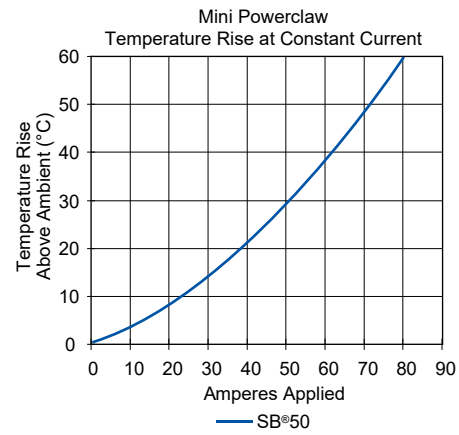
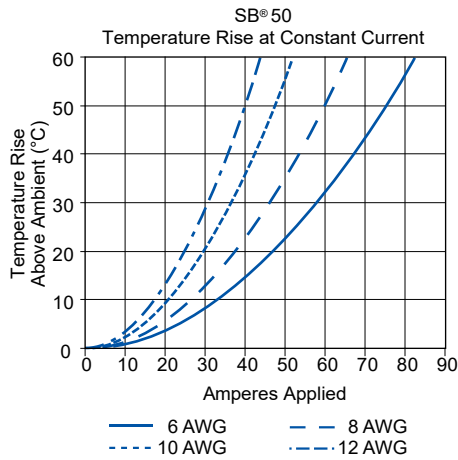

NOTE: Powerclaw charts are based on 8 AWG equivalent copper foil on board side, mated to 6 AWG conductor on wire side.

SB® 50 CONNECTOR SPECIFICATIONS

ELECTRICAL

| Current Rating Amperes ¹ | UL 1977 | CSA |
|-------------------------------------|---------|-----|
| Wire-to-Wire UL 1977 (6 AWG) | 120 | 50 |
| Wire-to-PCB UL 1977 (6 AWG) | 50 | |

Voltage Rating AC/DC

| | |
|---------|-----|
| UL 1977 | 600 |
|---------|-----|

PCB Connector Recommended Voltage per IEC 60950-1 Table 2L Pollution Degree ²

| | |
|---------------------|-----|
| Mini Vert. Contact | 522 |
| Mini Horiz. Contact | 504 |
| Standard Contact | 950 |

Dielectric Withstanding Voltage

| | |
|----------|-------|
| Volts AC | 2,200 |
|----------|-------|

Avg. Mated Contact Resistance Milliohms ¹

| | |
|----------------------|-------|
| 1 1/4" of 6 AWG wire | 0.200 |
| PCB Contact to Wire | 0.500 |

UL Hot Plug Current Rating Amperes - 250 Cycles at 120V DC

| | |
|--|-----|
| Wire to Wire | 50A |
| PCB to Wire (Vertical Mini Powerclaw) | 40A |

MATERIALS

Housing

| | |
|--------------------------|---------------------------|
| Standard Plastic Resin | Polycarbonate |
| Chem. Resistant Resin | Polycarbonate / PBT blend |
| Contact Retention Spring | Stainless Steel |

Housing Flammability Rating

| | |
|-----------|-----------------------------|
| UL94 | V-0 |
| Glow Wire | 960°C (GWFI) / 800°C (GWIT) |

Contact

| | |
|--------------|------------------|
| Base | Copper Alloy |
| Wire Plating | Silver |
| PCB Plating | Sn or Ag over Ni |

Contact Termination Methods

| | |
|--------------------|-----------------------|
| Crimp ³ | Wire Contacts |
| Hand Solder | Wire and PCB Contacts |
| Solder Dip | PCB Contacts |
| Wave Solder | PCB Contacts |
| Wrench / Socket | Busbar Contacts |

NOTE 1: See IEC 60664-1 for working voltage.

NOTE 2: Amp ratings are stated per position and based on all positions being fully loaded.

1 - Based on: 105°C rated or better cable of the largest size. Properly calibrated APP® recommended tooling, and a 25°C ambient temperature. UL rating not to exceed the maximum operating temperature. CSA rating below a 30°C temperature rise.

2 - Limited by the thermal properties of the connector plastic housing.

3 - Use APP® recommended tooling only. Alternate tools may adversely affect the performance of our connectors along with UL and CSA recognition.

4 - Tested with contact part number 5900.

* UL Rated for 65°C largest wire or cable size.

MECHANICAL

| Wire Size Range | AWG | mm ² |
|-----------------------------|---------|-----------------|
| Wire Contacts with Bushings | 16 to 6 | 1.3 to 13.3 |

| Max. Wire Insulation Diameter | in. | mm |
|-------------------------------|-------|--------|
| | 0.440 | 11.200 |

| Operating Temperature ² | °F | °C |
|------------------------------------|-------------|--------------|
| Standard | -4° to 221° | -20° to 105° |
| Chemical Resistant* | -40 to 221° | -40° to 105° |

*Chemical resistant material not available for PCB guide housings

| Mating Cycles No Load by Plating | Silver (Ag) | Tin (Sn) |
|----------------------------------|-------------|----------|
| Wire and PCB Contacts | 10,000 | 1,500 |

| Avg. Mating / Unmating Force | Lbf. | N |
|----------------------------------|------|----|
| Wire to Wire Low Force Contacts | 10 | 44 |
| Wire to Wire High Force Contacts | 15 | 67 |
| Standard Powerclaw to Wire | 15 | 66 |
| Mini Powerclaw to Wire | 8 | 36 |

PCB Specifications

| | |
|-----------------------------|--|
| Mounting Style | Plated Through Hole |
| Max PCB Thickness- in. (mm) | Standard: 0.15 (0.381) Mini: 0.25 (0.635) |
| Recommended Traces | 8 AWG Cross Section |

| Min. Contact / Spring Retention Force | Lbf. | N |
|---------------------------------------|------|-----|
| Wire Housing | 50 | 222 |

| Min. Creepage / Clearance Distance | in. | mm |
|------------------------------------|-------|-----|
| Standard Powerclaw | 0.374 | 9.5 |
| Mini Vert. Powerclaw | 0.213 | 5.4 |
| Mini Horiz. Powerclaw | 0.205 | 5.2 |

Mechanical Shock ⁴

| | | |
|-------------|-----------------|-------|
| MIL-STD-202 | 213 Condition A | 50g's |
|-------------|-----------------|-------|

Vibration High Frequency ⁴

| | | |
|-------------|-----------------|-------|
| MIL-STD-202 | 204 Condition A | 10g's |
|-------------|-----------------|-------|



IEC INFORMATION

| ATTRIBUTES | SB® 50 |
|---|--|
| AMP Rating AC/DC | 50 |
| Voltage Rating AC/DC (Steady State) | 250 |
| Breaking Capacity - AMP Rating / Cycles | 50 / 10 Cycles |
| Voltage Rating (Breaking Capacity) | 220 VDC |
| Finger Safety - Mated Only | IEC 60529 - IP20 |
| Wire Size Tested | 16 mm ² |
| Contact Series Tested | 5900/1307 |
| Climatic Testing (Cold, Heat & MFG) | IEC 60512 Test-11j, 11i & 11g |
| Cycle Life | IEC 60512 Test 9a - 5,000 Cycles |
| Mechanical Strength Impact | IEC 60512-5 @ 29.5 Inches- Dropped 8 times |
| Temperature Range | -20°C to 105°C -4°F to 221°F |

| Connector Series | Configurations | Creepage / Clearance per IEC 60950-1 | Material Group |
|------------------|----------------|--------------------------------------|----------------|
| SB® 50 | Unmated | 2.99 mm | IIIa |
| | Mated | 2.99 mm | |

PROTECTION

Touch Safety with Wire Contacts & PCB Mating Interface

IEC 60529 IP10 unmated

Environmental Sealing with Boots

IEC 60529 IP64



SB® Accessories

“T” Handle *

The “T” handle makes mating and unmating the connector easier. The non-conductive red plastic material is strong and safe. (2) Self tapping screws are used to secure the handle to the connector housing.

| Description | Part Numbers | |
|--------------------------------------|--------------|--------------|
| Minimum Quantity | 1,000 | 50 |
| Red “T” Handle + Hardware Bag | - | SB50-HDL-RED |
| Hardware Bag (2 Screws) | - | 104G17 |
| Red “T” Handle Only | 113899P1 | - |
| #8 x 5/8” Screw (Order 2 Per Handle) | H1120P55 | - |

* Torque value 12 (in - lbs) / 1.4 (Nm)

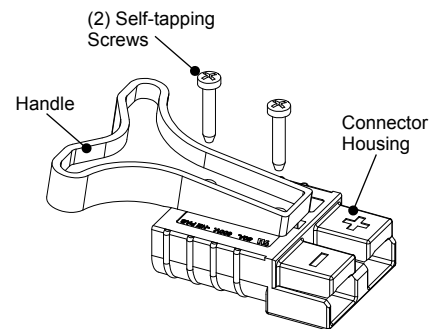

“A” frame handle for SB® 50 *

Handle makes mating and unmating the connector easier. The non-conductive gray plastic material is strong and safe. Machine screws and locknuts included.

| Description | Part Number |
|----------------------------|-------------|
| Minimum Quantity | 200 |
| Gray “A” Handle & Hardware | 997G1 |

* Torque value 12 (in - lbs) / 1.4 (Nm)

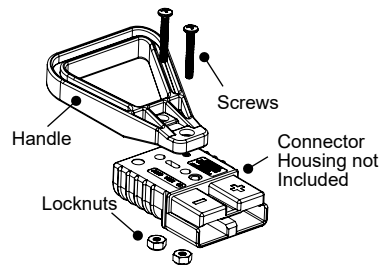

Dust Cover

Prevents dust and dirt from entering the mating interface of the connector when unmated.

NOTE: Not a Hermetic Seal.

| Description | Part Numbers | |
|------------------------------------|--------------|-------|
| Minimum Quantity | 500 | 50 |
| Dust Cover with Lanyard Strap, Red | 113890P1 | 134G1 |

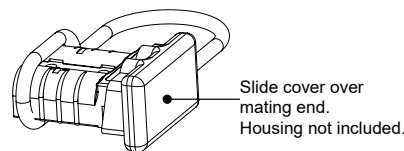

SB® Environmental Boots

SB® Environmental Boots provide water, dirt, chemical and UV protection for SB® 50 connectors. The durable boots shield the connectors from water and dirt to IP64 in both the mated and unmated condition.

| Description | Part Numbers | |
|--|--------------|----------|
| Minimum Quantity | 250 | 25 |
| SB® 50 Environmental Boot (with cover), Load | 3-6054P2-BK | 3-6054P2 |
| SB® 50 Environmental Boot (with cover), Source | 3-6055P2-BK | 3-6055P2 |
| SB® 50 Environmental Boot (no cover), Load | 3-6054P1-BK | 3-6054P1 |
| SB® 50 Environmental Boot (no cover), Source | 3-6055P1-BK | 3-6055P1 |

| Dimensions | | | | |
|------------|-------|-------|------|-------|
| - A - | | - B - | | - C - |
| in. | mm | in. | mm | in. |
| 5.9 | 151.4 | 1.8 | 45.1 | 6.3 |

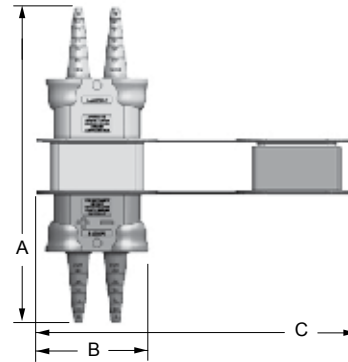

Guide Housings for Vertical Mini Powerclaw Contacts

Prevents polarity being reversed when a SB® 50 is mated to vertical mini Powerclaw contacts.

| Description | Part Numbers | |
|---------------------|--------------|-----------|
| Minimum Quantity | 1,000 | 50 |
| Black Guide Housing | PC-HSG-SB-BK | PC-HSG-SB |

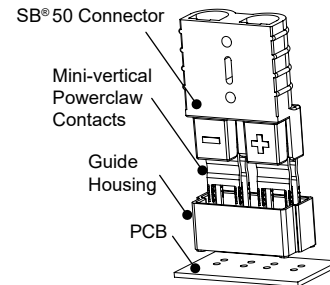

Cable Clamps

Durable metal cable clamps securely hold cables to prevent accidental strain or pulls from dislodging wire or contacts from the housing. Cable clamps are recommended for solder terminated wires.

| Description | Cable Size | | Part Numbers | |
|---------------------------------------|----------------------|------------------------------|--------------|-------|
| | AWG or (Inches O.D.) | mm ² or (mm O.D.) | | |
| Minimum Quantity | | | 500 | 50 |
| Self Attaching for Discrete Conductor | 8 to 6 | 10 | 990-BK | 990 |
| Self Attaching for Discrete Conductor | 12 to 10 | 4 to 6 | 990G2-BK | 990G2 |
| Bolt on for Discrete Conductor | 12 to 6 | 4 to 10 | 990G1-BK | 990G1 |
| Bolt on for Bundled Conductor | 0.320 to 0.450 | 4.27 to 11.43 | 5905-BK | 5905 |

* Torque value 12 (in - lbs) / 1.4 (Nm)

NOTE: For assembly of cable clamp to housing only

The given wire O.D. information is an estimate. Cable clamps should be evaluated for performance with the actual wire to be used.

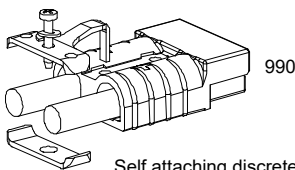

Self attaching discrete conductor

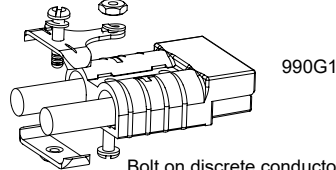

Bolt on discrete conductor

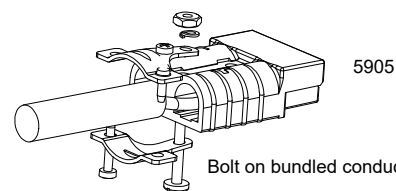

Bolt on bundled conductors

Reducing Bushings

Use with contact part number 5900-BK or 1307-BK to allow a smaller wire to be used with the connector. Electrical capability is derated with smaller wire.

| Contact Barrel Size | | Wire Size | | Part Numbers | | Dimensions | | | | |
|---------------------|-----------------|-----------|-----------------|--------------|---------|------------|------|------------|------|-------|
| AWG | mm ² | AWG | mm ² | | | - ID - | | - Length - | | |
| | | | | | | inches | mm | inches | mm | |
| Minimum Quantity | | | | 3,000 | 1,000 | 100 | | | | |
| 6 | 13.3 | 8 | 8.4 | - | 5912-BK | 5912 | 0.18 | 4.57 | 0.45 | 11.43 |
| 6 | 13.3 | 12 to 0 | 3.3 to 5.3 | 5910-BK | - | 5910 | 0.14 | 3.56 | 0.47 | 11.94 |
| 6 | 13.3 | 16 to 14 | 1.3 to 2.1 | 5913-BK | - | 5913 | 0.09 | 2.29 | 0.47 | 11.94 |

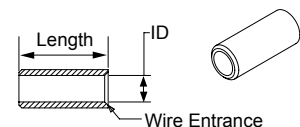

SB® 120 Connectors

Up to 240 Amps



Like the other Multipole connectors, the SB® 120 offers color-coded mechanically keyed housings. Keys can be used to identify and separate different circuits, or prevent users from accidentally cross mating different voltages. Wires sizes from 10 to 1 AWG (5.3 to 42.4 mm²) are held in the second smallest SB® housing.

- **New Extended Range Contacts Expand Wire Size up to 1 AWG (42.4 mm²)**

Allows UL rated currents up to 240 amps

- **Chemical Resistant Housing Option**

Extends temperature range down to -40°C, while offering enhanced UV and chemical resistance

- **Panel Mounting Grooves**

With use of mounting clamps, can be easily mounted through panels

SB® 120 ORDERING INFORMATION

SB® 120 Standard Housings

The second to smallest SB® housings work with wire contacts up to 1 AWG (35 mm²) as well as busbar contacts. Genderless design mates with itself. Mechanical keys are color-coded.

| Description | Part Numbers | |
|------------------|--------------|--------|
| Minimum Quantity | 250 | 50 |
| Red | 6810G3-BK | 6810G3 |
| Gray | 6810G1-BK | 6810G1 |
| Blue | 6810G2-BK | 6810G2 |

SB® 120 Chemical Resistant (CR) Housings

Same features as the Standard SB® 120 but molded in a chemical resistant PBT/PC blend. Suitable for use to -40°C.

| Description | Part Numbers | |
|------------------|--------------|---------|
| Minimum Quantity | 250 | 50 |
| Red | P6810G3-BK | P6810G3 |
| Gray | P6810G1-BK | P6810G1 |

SB® 120 Silver Plated Wire Contacts

Silver plated contacts offer superior electrical performance and durability up to 10,000 mating cycles. See reducing bushings in accessory section for smaller wires.

| AWG | mm ² | Mating Force | Loose Piece Part Numbers | | | Dimensions | | | |
|------------------|-----------------|--------------|---|-----------|--------|------------|--------|-------|------|
| | | | | | | - A - | | - B - | |
| | | | | | inches | mm | inches | mm | |
| Minimum Quantity | | | 600 | 500 | 50 | | | | |
| 1 | 42.4 | Low | 1323G1-BK | - | 1323G1 | 0.47 | 11.94 | 0.39 | 9.91 |
| 2 | 33.6 | High | - | 1319-BK | 1319 | 0.44 | 11.18 | 0.34 | 8.64 |
| 4 | 21.1 | High | - | 1319G4-BK | 1319G4 | 0.44 | 11.18 | 0.29 | 7.37 |
| 6 | 13.3 | High | - | 1319G6-BK | 1319G6 | 0.44 | 11.18 | 0.22 | 5.59 |
| 1 (set) | 42.4 | Low | 6811G7 (purchase as a set, no minimum quantity) | | | 0.47 | 11.94 | 0.39 | 9.91 |

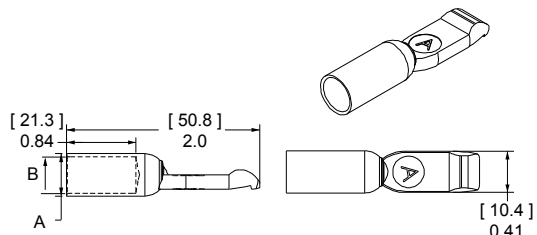
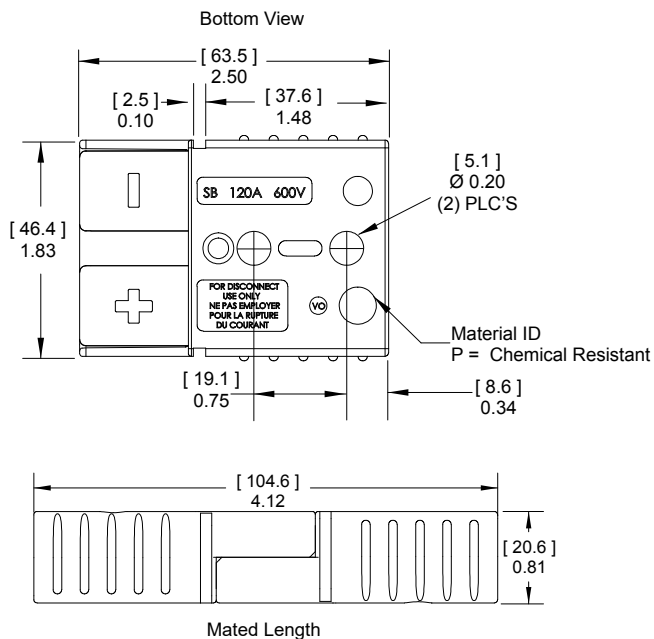

SB® 120 Silver Plated Busbar Contacts

Use 2 busbar contacts per housing to provide a quick disconnect input or output busbar connection. Busbar contacts are for mating with wire contacts only. Part number 120BBS includes lock nuts. Locknuts must be ordered separately for B01997P1.

| Type | Thread | Mating Force | Loose Piece Part Numbers | | |
|-------------------------|----------|--------------|--------------------------|----------|--------|
| Minimum Quantity | | | | | |
| Busbar | 10 to 24 | High | - | B01997P1 | 120BBS |
| Lock Nut | 10 to 24 | - | H1216P8 | - | 110G54 |

See Busbar contact drawing on website for further detail.

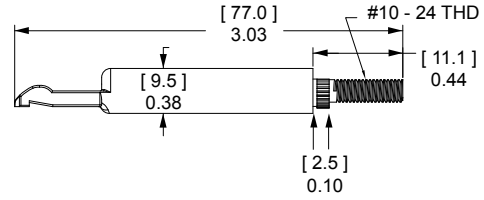

SB® 120 CONNECTOR TEMPERATURE CHARTS - Temperature rise charts are based on a 25°C ambient temperature.

Current - Temperature Derating per IEC 60512-5-2 Test 5B

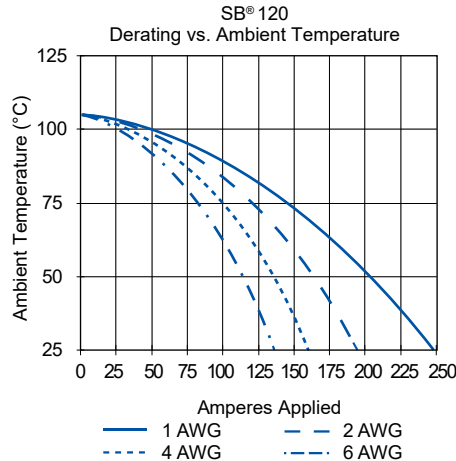
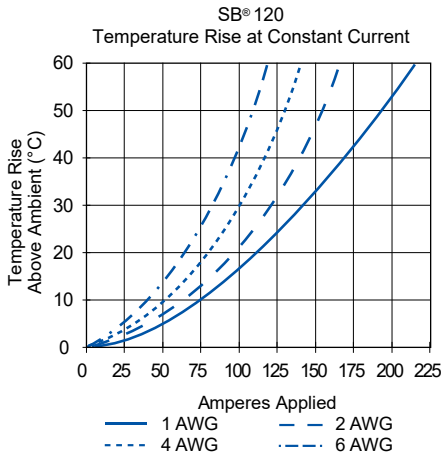

SB® 120 CONNECTOR SPECIFICATIONS

| MECHANICAL | | |
|--|--------------------|-----------------------|
| Wire Size Range | AWG | mm² |
| Wire Contacts with Bushings | 10 to 1 | 5.3 to 42.4 |
| Max. Wire Insulation Diameter | in. | mm |
| | 0.600 | 15.240 |
| Operating Temperature ² | °F | °C |
| Standard | -4° to 221° | -20° to 105° |
| Chemical Resistant | -40 to 221° | -40° to 105° |
| Mating Cycles No Load by Plating | Silver (Ag) | |
| Wire and Busbar Contacts | 10,000 | |
| Avg. Mating / Unmating Force | Lbf. | N |
| Wire to Wire | 20 | 89 |
| Min. Contact / Spring Retention Force | Lbf. | N |
| | 75 | 333.6 |

| MATERIALS | |
|------------------------------------|-----------------------------|
| Housing | |
| Standard Plastic Resin | Polycarbonate |
| Chem. Resistant Resin | Polycarbonate / PBT blend |
| Contact Retention Spring | Stainless Steel |
| Housing Flammability Rating | |
| UL94 | V-0 |
| Glow Wire | 960°C (GWFI) / 800°C (GWIT) |
| Wire & Busbar Contacts | |
| Base | Copper Alloy |
| Plating | Silver |
| Contact Termination Methods | |
| Crimp ³ | Wire Contacts |
| Hand Solder | Wire Contacts |
| Wrench / Socket | Busbar Contacts Only |

Specifications continued on next page

ELECTRICAL

| Current Rating Amperes ¹ | UL 1977 | CSA |
|--|---------|-----|
| Wire-to-Wire (1 AWG) | 240 | 130 |
| Wire-to-Busbar (2 AWG) | 120 | |
| Voltage Rating AC/DC | | |
| UL 1977 | 600 | |
| Dielectric Withstanding Voltage | | |
| Volts AC | 2,200 | |
| Avg. Mated Contact Resistance Milliohms ¹ | | |
| 5 1/2" of 2 AWG Wire | 0.136 | |
| Hot Plug Current Rating Amperes - Wire & Busbar | | |
| 250 cycles at 120V DC | 60A | |



NOTE 1: See IEC 60664-1 for working voltage.

NOTE 2: Amp ratings are stated per position and based on all positions being fully loaded.

1 - Based on: 105°C rated or better cable of the largest size. Properly calibrated APP® recommended tooling, and a 25°C ambient temperature. UL rating not to exceed the maximum operating temperature. CSA rating below a 30°C temperature rise.

2 - Limited by the thermal properties of the connector plastic housing.

3 - Use APP® recommended tooling only. Alternate tools may adversely affect the performance of our connectors along with UL and CSA recognition.

SB® 120

SB® 120 ACCESSORIES

Mounting Clamp for SB® 120

Mounting clamps can be used for fastening a SB® 120 series housings to a panel. Fastening hardware not included.

| Description | Part Number |
|---------------------|--------------|
| Minimum Quantity | 20 sets of 2 |
| Panel Mount Bracket | 1467G1 |

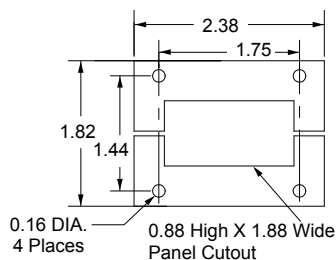

Cable Clamps *

Durable metal cable clamps securely hold cables to prevent accidental strain or pulls from dislodging wire or contacts from the housing. Cable clamps are recommended for solder terminated wires.

| Description | Cable Size | | Part Numbers |
|--------------------------------|-----------------------|-------------------|--------------|
| | Min / Max Inches O.D. | Min / Max mm O.D. | |
| Minimum Quantity | | | 50 |
| Bolt on for Discrete Conductor | 0.70 to 0.23 | 17.7 to 5.8 | 981G1 |
| Bolt on for Bundled Conductor | 0.73 to 0.29 | 18.5 to 7.3 | 981G2 |

* Torque value 21 (in lbs) / 2.4 (Nm) NOTE: For assembly of clamp to housing only

IEC INFORMATION

| ATTRIBUTES | SB®120 |
|---|---|
| AMP Rating AC/DC | 120 |
| Voltage Rating AC/DC (Steady State) | 400 V AC/DC (Operational) |
| Breaking Capacity - AMP Rating / Cycles | 120 Amp / 10 Cycles |
| Voltage Rating (Breaking Capacity) | 220 VDC |
| Finger Safety - Mated Only | IEC 60529- IP20 |
| Wire Size Tested | 50 mm ² |
| Contact Series Tested | 1323 |
| Climatic Testing Cold, Heat & MFG) | IEC 60512 Test-11j, 11i & 11g |
| Cycle Life | IEC 60512 Test 9a- 5,000 Cycles |
| Mechanical Strength Impact | IEC 60512-5 @ 29.5 Inches - Dropped 8 Times |
| Temperature Range | -20°C to 105°C -4°F to 221°F |

| Connector Series | Configurations | Creepage / Clearance per IEC 60950-1 | Material Group |
|------------------|----------------|--------------------------------------|----------------|
| SB® 120 | Unmated | 4.10 mm | IIla |
| | Mated | 4.10 mm | |

PROTECTION

Touch Safety with Wire Contacts

IEC 60529 IP10 unmated

Environmental Sealing with Boots

IEC 60529 IP64

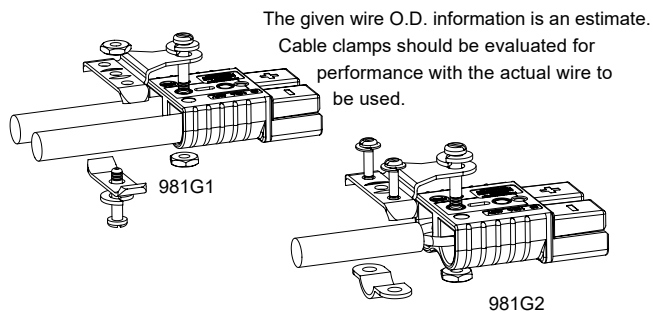

“A” Frame Handle for SB® 120 *

Handle makes mating and unmating the connector easier. The non-conductive gray plastic material is strong and safe. Machine screws and locknuts included.

| Description | Part Number |
|----------------------------|-------------|
| Minimum Quantity | 200 |
| Gray “A” Handle & Hardware | 997G1 |

* Torque value 21 (in - lbs) / 2.4 (Nm)

NOTE: For assembly of clamp to housing only

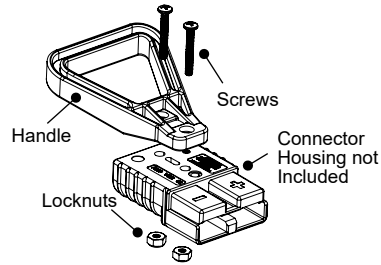

“T” Handle *

The “T” handle makes mating and unmating the connector easier. The non-conductive red plastic material is strong and safe. (2) Self tapping screws are used to secure the handle to the connector housing.

| Description | Part Numbers | |
|--------------------------------------|--------------|---------------|
| Minimum Quantity | 1,000 | 50 |
| Red “T” Handle + Hardware Bag | - | SB120-HDL-RED |
| Red “T” Handle Only | 113899P1 | - |
| #8 x 7/8” Screw (Order 2 Per Handle) | H1120P43 | - |

* Torque value 21 (in - lbs) / 2.4 (Nm)

NOTE: For assembly of clamp to housing only

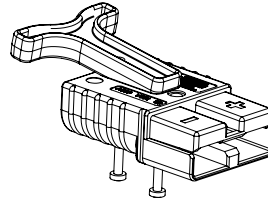

Dust Cover

Prevents dust and dirt from entering the mating interface of the connector when unmated. NOTE: Not a Hermetic Seal.

| Description | Part Numbers | |
|--------------------------------------|--------------|-------|
| Minimum Quantity | 100 | 50 |
| Dust Cover with Lanyard Strap, Black | B02019P1 | 134G4 |

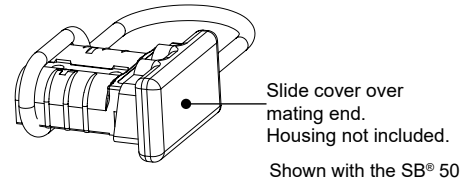

SB® 120 Environmental Boots

Environmental Boots provide water, dirt, chemical and UV protection for SB® 120 connectors. The durable boots shield the connectors from water and dirt to IP64 in both the mated and unmated condition.

| Description | Part Numbers | |
|------------------------------------|--------------|----------|
| Minimum Quantity | 250 | 25 |
| SB® 120 Environmental Boot, Load | 3-6035P1-BK | 3-6035P1 |
| SB® 120 Environmental Boot, Source | 3-6034P1-BK | 3-6034P1 |

| Dimensions | | | | | |
|------------|-----|-------|----|-------|-----|
| - A - | | - B - | | - C - | |
| in. | mm | in. | mm | in. | mm |
| 7.9 | 201 | 2.8 | 71 | 8.0 | 203 |

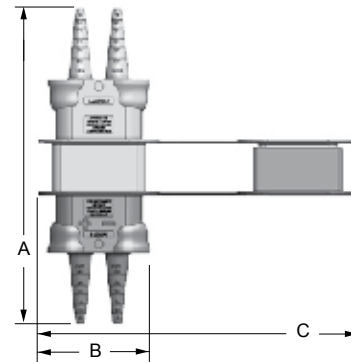

Reducing Bushings

Use with contact part number 1319-BK to allow a smaller wire to be used with the connector. Electrical capability is derated with smaller wire.

| Contact Barrel Size | | Wire Size | | Part Numbers | | | Dimensions - ID - | |
|---------------------|------|-----------|------------|--------------|---------|------|-------------------|------|
| AWG | mm² | AWG | mm² | | | | inches | mm |
| Minimum Quantity | | 2,000 | 1,000 | 100 | | | | |
| 2 | 33.6 | 4 | 21.2 | 5919-BK | - | 5919 | 0.28 | 7.11 |
| 2 | 33.6 | 6 | 16 | - | 5920-BK | 5920 | 0.23 | 5.84 |
| 2 | 33.6 | 10 to 8 | 5.3 to 8.4 | 5921-BK | | 5921 | 0.18 | 4.57 |

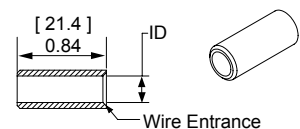

SB[®] 175 Connectors

Up to 280 Amps



Wires sizes from 10 to 1/0 AWG (5.3 to 50 mm²) fit in the second to largest connector in the SB[®] series. The 3 pole SB[®] 175 adds an additional position for power or grounding. All Multipole wire connector housings are genderless and mate to themselves minimizing inventory and assembly complexity.

- **Silver Plated Wire Contacts up to 1/0 (50 mm²)**
Allows UL rated currents up to 280 amps
- **Chemical Resistant Housing Option**
Extends temperature range down to -40°C, while offering enhanced UV and chemical resistance
- **UL Rated for Hot Plugging up to 100 Amps**
Great for battery or other applications where the ability to interrupt circuits is required

SB[®] 175

SB[®] 175 ORDERING INFORMATION

SB[®] 175 Standard Housings

The second to largest SB[®] housings work with wire contacts up to 1/0 AWG (50 mm²) as well as busbar contacts. Genderless design mates with itself. Mechanical keys are color-coded. *NOTE: SB[®] 175 black housing is keyless and can be mated with all other colors.*

| Description | Part Numbers | |
|------------------|--------------|-----|
| Minimum Quantity | 200 | 50 |
| Yellow | 943-BK | 943 |
| Orange | 942-BK | 942 |
| Red | 949-BK | 949 |
| Gray | 940-BK | 940 |
| Blue | 941-BK | 941 |
| Black (Keyless) | 2-7252G11 | - |

SB[®] 175 Chemical Resistant Housings

Same features as the Standard SB[®] 175 but molded in a chemical resistant PBT/ PC blend. Suitable for use to -40°C.

| Description | Part Numbers | |
|------------------|--------------|------|
| Minimum Quantity | 200 | 50 |
| Red | P949-BK | P949 |
| Gray | P940-BK | P940 |

SB[®] 175 2/0 Housing

Genderless design mates with itself. Can be cross mated with gray SB[®] 175 housing, but amperage capability is limited to the SB[®] 175 rating with the wire and contact used.

| Description | Voltage | Part Number |
|------------------|---------|-------------|
| Minimum Quantity | | 100 |
| Gray | 36V | 115107G1 |

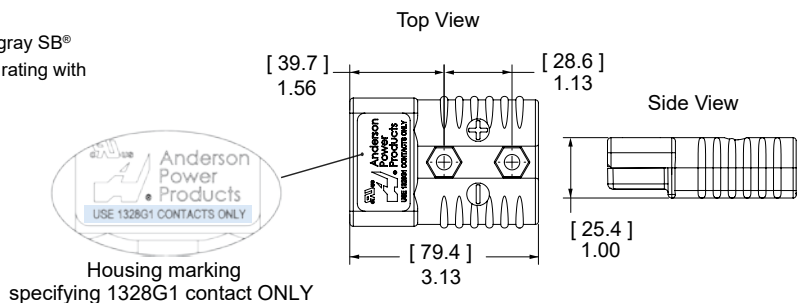
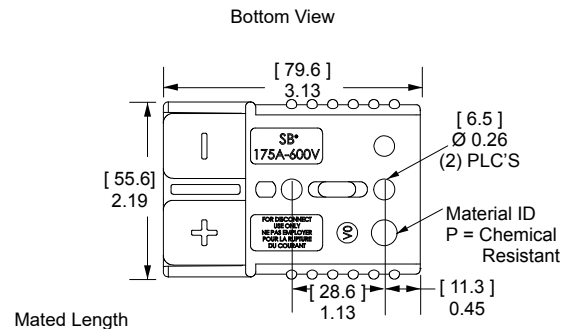

SB® 175 3 Pole Housings & Hardware

A three pole version of the standard SB® 175 housing has a two piece housing with springs and hardware. Useful for DC 2 wire plus ground and AC single phase applications.

| Description | Part Numbers | |
|-------------------------------|--------------|--------|
| Minimum Quantity | 100 | 25 |
| Gray Housing and Hardware Kit | - | 902 |
| Gray Housing Top Half | 2-5048 | - |
| Gray Housing Bottom Half | 2-5049 | - |
| Hardware Kit | - | 110G34 |

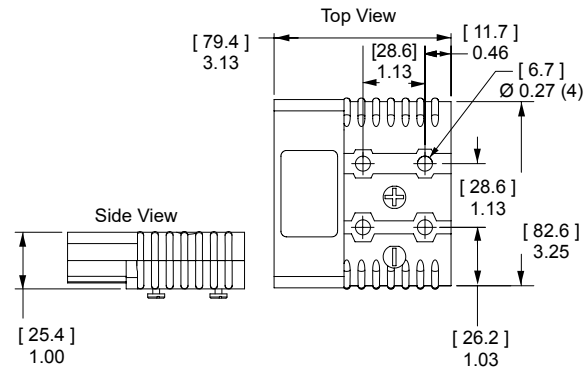

SB® 175 Silver Plated Wire Contacts

Silver plated contacts offer superior electrical performance and durability up to 10,000 mating cycles. See reducing bushings in accessory section for smaller wires.

| AWG | mm ² | Mating Force | Loose Piece Part Numbers | Dimensions | | | | | | | | |
|------------------|-----------------|--------------|--------------------------|------------|------|--------|------|--------|------|--------|------|-------|
| | | | | - A - | | - B - | | - C - | | - D - | | |
| | | | | inches | mm | inches | mm | inches | mm | inches | mm | |
| Minimum Quantity | | | 500 | 50 | | | | | | | | |
| 1/0 | 53.5 | High | 1382-BK | 1382 | 2.35 | 59.69 | 0.52 | 13.21 | 0.44 | 11.18 | 1.04 | 26.42 |
| 1 | 42.4 | High | 1347-BK | 1347 | 2.35 | 59.69 | 0.52 | 13.21 | 0.39 | 9.91 | 1.04 | 26.42 |
| 2 | 33.6 | High | 1383-BK | 1383 | 2.35 | 59.69 | 0.52 | 13.21 | 0.35 | 8.89 | 1.04 | 26.42 |
| 4 | 21.1 | High | 1384-BK | 1384 | 2.35 | 59.69 | 0.52 | 13.21 | 0.30 | 7.62 | 1.04 | 26.42 |
| 6 | 13.3 | High | 1348-BK | 1348 | 2.10 | 53.34 | 0.37 | 9.40 | 0.22 | 5.59 | 0.80 | 26.42 |
| 2/0 * | 70 | Low | 1328G1-BK | 1328G1 | 2.35 | 59.69 | 0.64 | 16.26 | 0.49 | 12.45 | 1.04 | 26.42 |

* Use with 115107G1 only

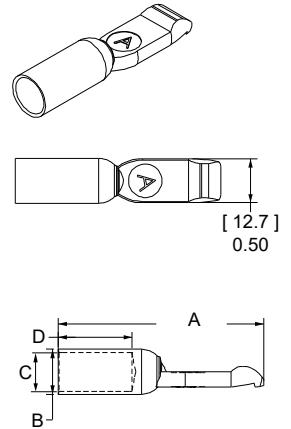

SB® 175 Silver Plated Busbar Contacts

Provides a quick disconnect input or output busbar connection. Busbar contacts are for mating with wire contacts only. Part number 180BBS includes lock nuts. Locknuts must be ordered separately for 180BBS-BK.

| Type | Thread | Mating Force | Loose Piece Part Numbers | | |
|------------------|--------|--------------|--------------------------|-----------|--------|
| Minimum Quantity | | | 1,000 | 120 | 10 |
| Busbar | 1/4-20 | High | - | 180BBS-BK | 180BBS |
| Lock Nut | 1/4-20 | - | H1216P7 | 110G56 | 110G55 |

See Busbar contact drawing on website for further detail.

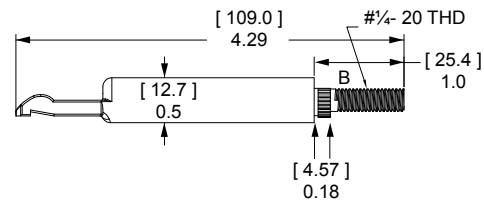

Silver Plated Wire Contacts - use with 2/0 Housing ONLY

Silver plated contacts offer superior electrical performance and durability up to 5,000 mating cycles.

| Type | AWG | mm ² | Loose Piece Part Numbers | Dimensions | | | | | | | | |
|------------------|-----|-----------------|--------------------------|------------|------|--------|------|--------|------|--------|------|-------|
| | | | | - A - | | - B - | | - C - | | - D - | | |
| | | | | inches | mm | inches | mm | inches | mm | inches | mm | |
| Minimum Quantity | | | 300 | 50 | | | | | | | | |
| Individual | 2/0 | 70 | 1328G1-BK | 1328G1 | 2.35 | 59.69 | 0.64 | 16.26 | 0.49 | 12.45 | 1.04 | 26.42 |

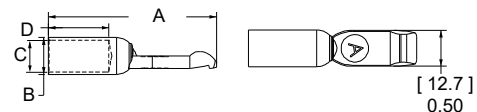

SB® 175 CONNECTOR TEMPERATURE CHARTS – Temperature rise charts are based on a 25°C ambient temperature.

Current - Temperature Derating per IEC 60512-5-2 Test 5B

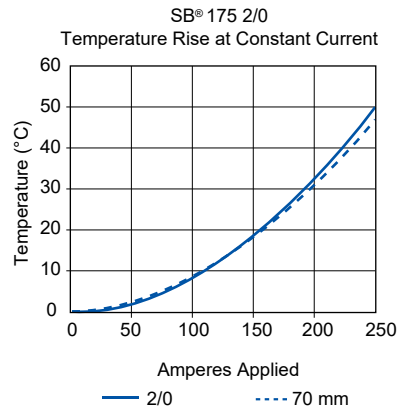
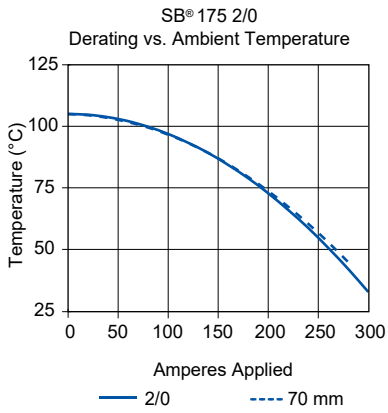
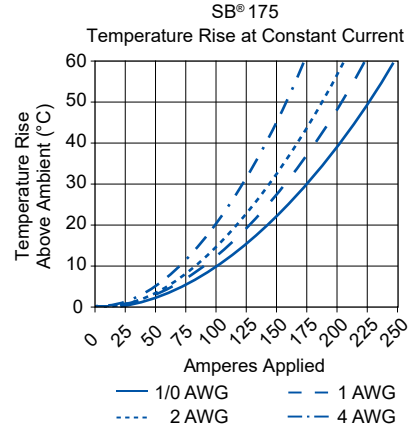
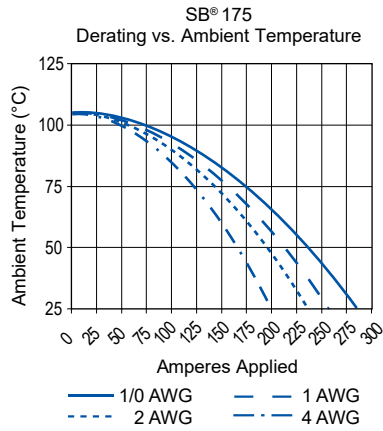

SB® 175

SB® 175 CONNECTOR SPECIFICATIONS

ELECTRICAL

| Current Rating Amperes ¹ | UL 1977 | CSA |
|--|---------|-----|
| Wire-to-Wire (1/0 AWG) | 280 | 175 |
| Wire-to-Busbar (1/0 AWG) | 200 | |
| 3 Pole Wire-to-Wire (1/0 AWG) | 175 | |
| Voltage Rating AC/DC | | |
| UL 1977 | 600 | |
| Dielectric Withstanding Voltage | | |
| Volts AC | 2,200 | |
| Avg. Mated Contact Resistance Milliohms ¹ | | |
| 6" of 1/0 AWG wire | 0.100 | |
| Hot Plug Current Rating Amperes - Wire & Busbar | | |
| 250 cycles at 120V DC 1/0 Wires | 100A | |

MATERIALS

| Housing | |
|-----------------------------|-----------------------------|
| Standard Plastic Resin | Polycarbonate |
| Chem. Resistant Resin | Polycarbonate / PBT blend |
| Contact Retention Spring | Stainless Steel |
| Housing Flammability Rating | |
| UL94 | V-0 |
| Glow Wire | 960°C (GWFI) / 850°C (GWIT) |
| Wire & Busbar Contacts | |
| Base | Copper Alloy |
| Plating | Silver |
| Contact Termination Methods | |
| Crimp ³ | Wire Contacts |
| Hand Solder | Wire Contacts |
| Wrench / Socket | Busbar Contacts Only |

MECHANICAL

| Wire Size Range | AWG | mm ² |
|---------------------------------------|-----------------|-----------------|
| Wire Contacts with Bushings | 10 to 1/0 | 5.3 to 53.5 |
| Max. Wire Insulation Diameter | in. | mm |
| | 0.600 | 15.240 |
| Operating Temperature ² | °F | °C |
| Standard | -4° to 221° | -20° to 105° |
| Chemical Resistant | -40 to 221° | -40° to 105° |
| Mating Cycles No Load by Plating | Silver (Ag) | |
| Wire and Busbar Contacts | 10,000 | |
| Avg. Mating / Unmating Force | Lbf. | N |
| 2 Pole | 25 | 111 |
| 3 Pole | 35 | 156 |
| Min. Contact / Spring Retention Force | Lbf. | N |
| | 150 | 667 |
| Mechanical Shock ⁴ | | |
| MIL-STD-202 | 213 Condition A | 50g's |
| Vibration High Frequency ⁴ | | |
| MIL-STD-202 | 204 Condition A | 10g's |



NOTE 1: See IEC 60664-1 for working voltage.

NOTE 2: Amp ratings are stated per position and based on all positions being fully loaded.

1 - Based on: 105°C rated or better cable of the largest size. Properly calibrated APP® recommended tooling, and a 25°C ambient temperature. UL rating not to exceed the maximum operating temperature. CSA rating below a 30°C temperature rise.

2 - Limited by the thermal properties of the connector plastic housing.

3 - Use APP® recommended tooling only. Alternate tools may adversely affect the performance of our connectors along with UL and CSA recognition.

4 - Tested with contact part number 1382.

SB® 175 CONNECTOR IEC INFORMATION

| Connector Series | Configurations | Creepage / Clearance per IEC 60950-1 | Material Group |
|------------------|----------------|--------------------------------------|----------------|
| SB® 175 | Unmated | 5.73 mm | IIIa |
| | Mated | 5.73 mm | |

PROTECTION

Touch Safety with Wire Contacts

IEC 60529 IP10 unmated

Environmental Sealing with Boots

IEC 60529 IP64

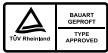

| ATTRIBUTES | SB® 175 |
|---|---|
| AMP Rating AC/DC | 175 |
| Voltage Rating AC/DC (Steady State) | 500 V AC/DC (Operational) |
| Breaking Capacity - AMP Rating / Cycles | 175 Amp / 10 Cycles |
| Voltage Rating (Breaking Capacity) | 220 VDC |
| Finger Safety - Mated Only | IEC 60529 - IP20 |
| Wire Size Tested | 50 mm ² |
| Contact Series Tested | 1382 |
| Climatic Testing (Cold, Heat & MFG) | IEC 60512 Test-11j, 11i & 11g |
| Cycle Life | IEC 60512 Test 9a- 5000 Cycles |
| Mechanical Strength Impact | IEC 60512-5 @ 29.5 Inches- Dropped 8 Times |
| Temperature Range | -20 °C to 105 °C -4 °F to 221 °F |

SB® 175

SB® 175 2/0 CONNECTOR SPECIFICATIONS

| ELECTRICAL | | |
|--|--------------------|---------|
| Current Rating (Amperes) ¹ | UL 1977 | CSA |
| | 2/0 AWG | 340 200 |
| | 70 mm ² | 315 185 |
| Voltage Rating (AC/DC) | 600 | |
| Dielectric Withstanding Voltage (AC) | 2,200 | |
| AVG Contact Resistance (milli-ohms) ¹ | 0.045 | |

MATERIALS

| | |
|---------------------|----------------------------|
| Standard Housing | PC |
| Flammability Rating | UL94 V-0 |
| Wire Power Contact | Copper Alloy, Silver Plate |

Contact Termination Methods

- Crimp ³
- Hand Solder

| MECHANICAL | | |
|---|--------------------|--------------------------|
| Contact Wire Range (AWG) | 2/0 | |
| | (mm ²) | 70 |
| MAX Wire Insulation Diameter (in) | 0.67 | |
| | (mm) | 17.04 |
| Operating Temperature ² | °C | °F |
| | PC Housing | -20° to 105° -4° to 221° |
| AVG Contact Retention Force for Standard PC Housing | | |
| | (lbf) | 150 lbf |
| | (N) | 667 n |
| Mating Cycles (no load) | 5,000 | |
| Connector AVG Connect / Disconnect | (lbf) | 55 |
| | (N) | 245 |



¹ Based on: 105°C rated or better cable of the largest size. Properly calibrated APP® recommended tooling, and a 25°C ambient temperature. UL rating not to exceed the maximum operating temperature. CSA rating below a 30°C temperature rise.
² Limited by the thermal properties of the connector plastic housing.
³ Use APP® recommended tooling only. Alternate tools may adversely affect the performance of our connectors along with UL and CSA recognition.

SB® 175 ACCESSORIES

Cable Clamps

Durable metal cable clamps securely hold cables to prevent accidental strain or pulls from dislodging wire or contacts from the housing. Only Bolt On type clamps can be used with the handles. Cable clamps are recommended for solder terminated wires. Not for use with 3 pole housing.

| Description | Cable Size | | Part Numbers | |
|---------------------------------------|------------------------------|-------------------------|--------------|-------|
| | Max / Min In. Inches O.D. | Max / Min mm mm O.D. | 100 | 50 |
| Self Attaching for Discrete Conductor | 0.55 to 0.24 | 14 to 6 | 105G3 | 945 |
| Bolt On for Discrete Conductor | 0.66 to 0.24 | 16.7 to 6.2 | 945G3-BK | 945G3 |
| Bolt On for Bundled Conductor | 0.75 to 0.29 | 18.3 to 7.3 | 946G1-BK | 946G1 |

* Torque value 30 (in - lbs) / 3.4 (Nm)

NOTE: For assembly of clamp to housing only

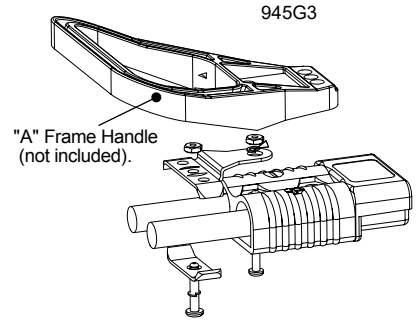
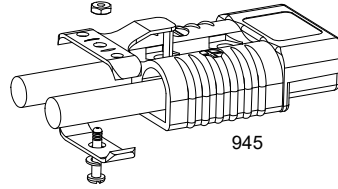
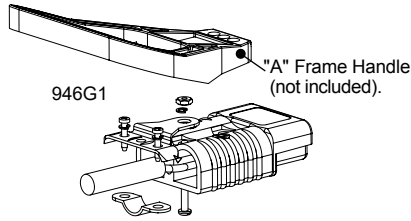

The given wire O.D. information is an estimate. Cable clamps should be evaluated for performance with the actual wire to be used.

Handles

Handles are made out of durable PC plastic. Hardware to attach to connector body included in kits. Not for use with 3 pole housing.

| Description | Part Numbers | |
|--------------------|--------------|-------|
| Minimum Quantity | 100 | 25 |
| Gray Handle Kit | - | 995G1 |
| Red Handle Kit | - | 995G3 |
| Handle Only, Gray | 3-5074P1 | - |
| Handle Only, Red | 3-5074P3 | - |
| Handle Only, Black | 3-5074P5 | - |
| Hardware Bag | - | 105G8 |

* Torque value 30 (in lbs) / 3.4 (Nm)

NOTE: For assembly of clamp to housing only

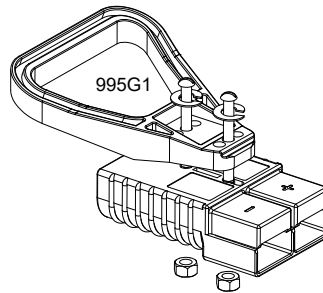

Dust Cover

Prevents dust and dirt from entering the mating interface of the connector when unmated. NOTE: Not a Hermetic Seal. Not for use with 3 pole housing.

| Description | Part Numbers | |
|------------------------------------|--------------|-------|
| Minimum Quantity | 500 | 50 |
| Dust Cover with Lanyard Strap, Red | 113890P2 | 134G2 |

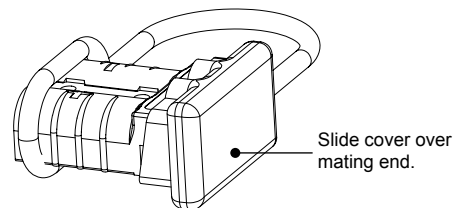

SB® Environmental Boots

SB® Environmental Boots provide water, dirt, chemical and UV protection for SB® 175 connectors. The durable boots shield the connectors from water and dirt to IP64* in both the mated and unmated condition.

| Description | Part Numbers | | Dimensions | | | | | |
|------------------------------------|--------------|----------|------------|-----|-------|----|-------|-----|
| | | | - A - | | - B - | | - C - | |
| | | | in. | mm | in. | mm | in. | mm |
| Minimum Quantity | 250 | 25 | | | | | | |
| SB® 175 Environmental Boot, Load | 3-6037P1-BK | 3-6037P1 | 9.5 | 241 | 3.2 | 80 | 9.3 | 236 |
| SB® 175 Environmental Boot, Source | 3-6036P1-BK | 3-6036P1 | 9.5 | 241 | 3.2 | 80 | 9.3 | 236 |

* IP64 test pending

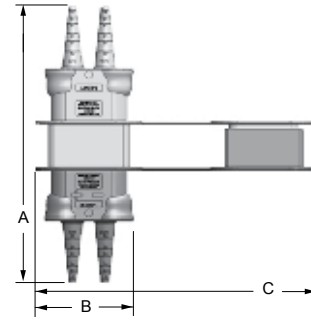

SB® 175 Lockout

Works with standard lockout - tagout equipment to prevent access to the mating interface of the connector. Made from durable PC plastic. Can be used with 3 pole housing to lockout positive and negative positions only.

| Description | Part Number |
|--------------------------|---------------|
| Minimum Quantity | 25 |
| Red Lockout - Tagout Kit | SB175-LOCKOUT |

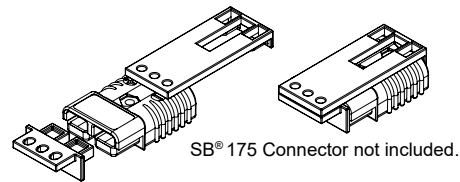

Manual Release Bracket - Mounting Side *

Works with the Locking Side to ease mating and unmating connectors. Not for use with 3 pole housing.

| Description | Part Number |
|---------------------------------|-------------|
| Minimum Quantity | 10 |
| Mounting Plate and Hardware Kit | 924G1 |

* Torque value 30 (in - lbs) / 3.4 (Nm)

NOTE: For assembly of bracket to housing only

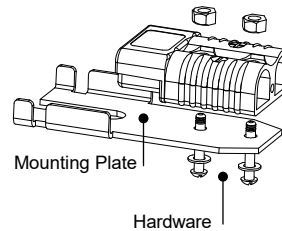

Manual Release Bracket - Locking Side *

Works with the Mounting Side to ease mating and unmating connectors. Not for use with 3 pole housing.

| Description | Cable Size | | Part Number |
|--|-----------------------|-------------------|-------------|
| | Max / Min Inches O.D. | Max / Min mm O.D. | |
| Minimum Quantity | | | 10 |
| Locking plate, handle, clamp and hardware kit. | 0.50 to 0.21 | 12.6 to 5.4 | 923G1 |

* Torque value 30 (in - lbs) / 3.4 (Nm)

NOTE: For assembly of bracket to housing only

The given wire O.D. information is an estimate. Cable clamps should be evaluated for performance with the actual wire to be used.

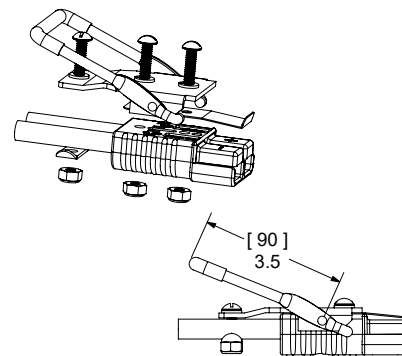

Reducing Bushings: for Use with Contact Part Number 1382

Use with contact part number 1382-BK to allow a smaller wire to be used with the connector. Electrical capability is derated with smaller wire.

| Contact Barrel Size | | Wire Size | | Part Numbers | | | | Dimensions - ID - | |
|---------------------|-----------------|-----------|-----------------|--------------|---------|---------|------|----------------------|------|
| AWG | mm ² | AWG | mm ² | | | | | inches | mm |
| Minimum Quantity | | | | 1,500 | 1,000 | 500 | 100 | | |
| 1/0 | 53.5 | 1 | 42.4 | - | - | 5687-BK | 5687 | 0.39 | 9.91 |
| 1/0 | 53.5 | 2 | 33.6 | 5690-BK | - | - | 5690 | 0.34 | 8.64 |
| 1/0 | 53.5 | 4 | 21.2 | - | 5693-BK | - | 5693 | 0.27 | 6.86 |
| 1/0 | 53.5 | 6 | 13.3 | - | 5663-BK | - | 5663 | 0.22 | 5.59 |
| 1/0 | 53.5 | 10 to 8 | 5.3 to 8.4 | 5648-BK | - | - | 5648 | 0.19 | 4.83 |

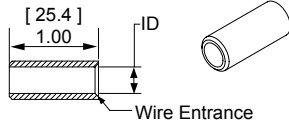

SB® 350 Connectors

Up to 500 Amps



The SB® 350 is the largest connector in the series with power capabilities up to 500 amps with a 350 mcm wire. Wires ranging from 1/0 to 350 mcm (53.5 to 185 mm²) fit into the one piece housing available in standard PC or a chemical resistant PBT/PC blend. Silver plated wire or busbar contacts minimize electrical resistance while offering supreme durability and reliability.

- **Up to 350 mcm (185 mm²) Wires**
Allows UL rated currents up to 500 amps
- **Chemical Resistant Housing Option**
Extends temperature range down to -40°C, while offering enhanced UV and chemical resistance
- **Same Housings Used for Wire and Busbar Contacts**
Enables color-coded mechanically keyed wire to busbar connections

SB® 350 ORDERING INFORMATION

SB® 350 Standard Housings

The largest SB® housings work with wire contacts up to 350 mcm (150 mm²) as well as busbar contacts. Genderless design mates with itself. Mechanical keys are color-coded. *NOTE: SB® 350 Black and Blue Housings have the same keying features and can be intermated.*

| Description | Part Numbers | |
|------------------|--------------|-----|
| Minimum Quantity | 50 | 25 |
| Yellow | 914-BK | 914 |
| Orange | 932-BK | 932 |
| Red | 913-BK | 913 |
| Gray | 906-BK | 906 |
| Blue | 912-BK | 912 |
| Green | 931-BK | 931 |
| Black | 2-7250G8 | - |

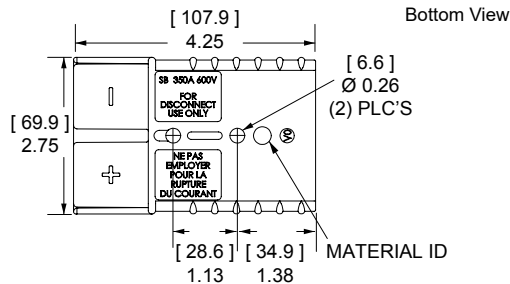

P = Chemical Resistant

SB® 350 Chemical Resistant Housings

Same features as the Standard SB® 350 but molded in a chemical resistant PBT/ PC blend. Suitable for use to -40°C.

| Description | Part Numbers | |
|------------------|--------------|------|
| Minimum Quantity | 50 | 25 |
| Red | P913-BK | P913 |
| Gray | P906-BK | P906 |

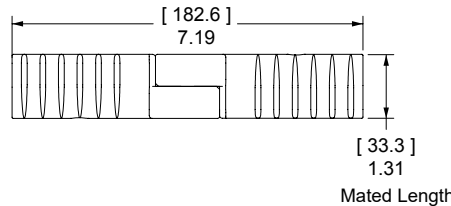

SB® 350 Silver Plated Wire Contacts

Silver plated contacts offer superior electrical performance and durability up to 10,000 mating cycles. See reducing bushings in accessory section for smaller wires.

| AWG | mm ² | Mating Force | Loose Piece Part Numbers | | Dimensions | | | | | | | | | |
|------------------|-----------------|--------------|--------------------------|--------|------------|--------|-------|--------|-------|--------|------|--|--|--|
| | | | - A - | - B - | - C - | inches | mm | inches | mm | inches | mm | | | |
| Minimum Quantity | | | 200 | 150 | 50 | | | | | | | | | |
| 350 mcm | 185 | High | - | 910-BK | 910 * | 0.75 | 19.05 | 0.87 | 22.10 | 3.04 | 77.2 | | | |
| 300 mcm | 152 | High | - | 910-BK | 910 * | 0.75 | 19.05 | 0.87 | 22.10 | 3.04 | 77.2 | | | |
| 4/0 | 107.2 | High | - | 908-BK | 908 * | 0.64 | 16.26 | 0.75 | 19.05 | 3.03 | 77.0 | | | |
| 3/0 | 85 | High | - | 916-BK | 916 * | 0.58 | 14.73 | 0.70 | 17.78 | 3.00 | 76.2 | | | |
| 2/0 | 67.4 | High | - | 907-BK | 907 * | 0.49 | 12.45 | 0.64 | 16.26 | 2.96 | 75.2 | | | |
| 1/0 | 53.5 | High | - | 917-BK | 917 * | 0.44 | 11.18 | 0.51 | 12.95 | 2.91 | 73.9 | | | |

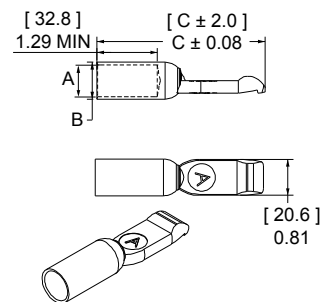

* Sold as pairs. 2 parts shipped for every 1 part ordered.

SB® 350 Silver Plated Busbar Contacts

Use 2 busbar contacts per housing to provide a quick disconnect input or output busbar connection. Busbar contacts are for mating with wire contacts only. Part number 350BBS includes lock nuts. Locknuts must be ordered separately for B01998P1.

| Type | Thread | Mating Force | Loose Piece Part Numbers | |
|-------------------------|--------|--------------|--------------------------|--------|
| Minimum Quantity | | | | |
| Busbar | 3/8-16 | High | B01998P1 | 350BBS |
| Lock Nut | 3/8-16 | - | H1216P9 | 110G73 |

NOTE: Has not been tested by UL.

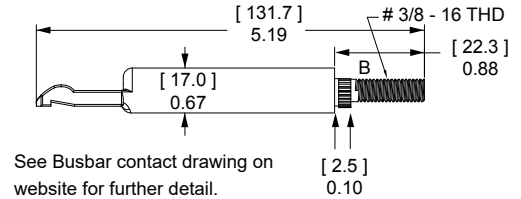

SB® 350 CONNECTOR TEMPERATURE CHARTS - Temperature rise charts are based on a 25°C ambient temperature.

Current - Temperature Derating per IEC 60512-5-2 Test 5B

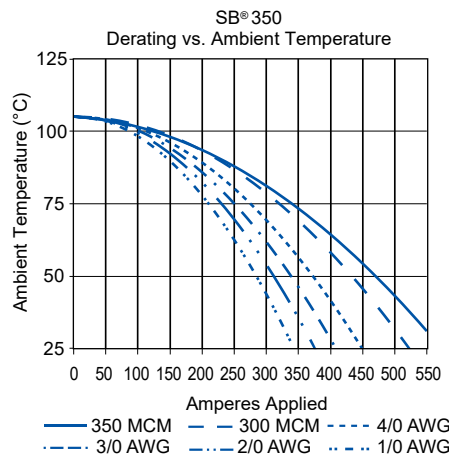
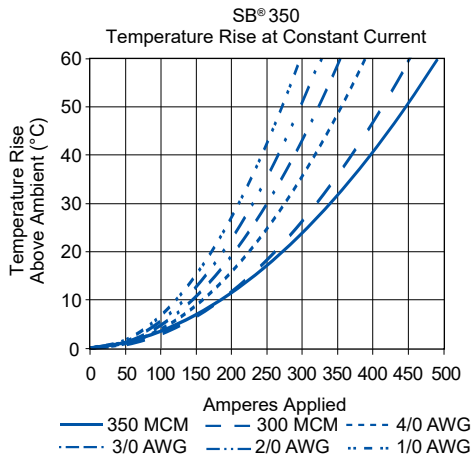

SB® 350 CONNECTOR SPECIFICATIONS

| ELECTRICAL | | |
|---|----------------|------------|
| Current Rating Amperes ¹ | UL 1977 | CSA |
| Wire-to-Wire (350 mcm) | 500 | 325 |
| Voltage Rating AC/DC | | |
| UL 1977 | 600 | |
| Dielectric Withstanding Voltage | | |
| Volts AC | 2,200 | |
| Avg. Mated Contact Resistance Milliohms ¹ | | |
| 2 1/2" of 300 mcm Wire | 0.050 | |
| Hot Plug Current Rating Amperes - Wire & Busbar | | |
| 250 cycles at 120V DC | 100A | |

| MECHANICAL | | |
|--|--------------------|-----------------------|
| Wire Size Range | AWG | mm² |
| Wire Contacts with Bushings | 1/0 to 350 mcm | 53.5 to 185 |
| Max. Wire Insulation Diameter | in. | mm |
| | 1.100 | 27.900 |
| Operating Temperature ² | °F | °C |
| Standard | -4° to 221° | -20° to 105° |
| Chemical Resistant | -40 to 221° | -40° to 105° |
| Mating Cycles No Load by Plating | Silver (Ag) | |
| Wire and Busbar Contacts | 10,000 | |
| Avg. Mating / Unmating Force | Lbf. | N |
| 2 Pole | 30 | 133 |
| Min. Contact / Spring Retention Force | Lbf. | N |
| | 150 | 667 |

Specifications continued on next page

MATERIALS

Housing

| | |
|--------------------------|---------------------------|
| Standard Plastic Resin | Polycarbonate |
| Chem. Resistant Resin | Polycarbonate / PBT blend |
| Contact Retention Spring | Stainless Steel |

Housing Flammability Rating

| | |
|-----------|----------------------------|
| UL94 | V-0 |
| Glow Wire | 960°C (GWFI) / 800°C GWIT) |

Wire & Busbar Contacts ⁴

| | |
|---------|--------------|
| Base | Copper Alloy |
| Plating | Silver |

Contact Termination Methods

| | |
|--------------------|-----------------|
| Crimp ³ | Wire Contacts |
| Hand Solder | Wire Contacts |
| Wrench / Socket | Busbar Contacts |



NOTE 1: See IEC 60664-1 for working voltage.

1 - Based on: 105°C rated or better cable of the largest size. Properly calibrated APP® recommended tooling, and a 25°C ambient temperature. UL rating not to exceed the maximum operating temperature. CSA rating below a 30°C temperature rise.

2 - Limited by the thermal properties of the connector plastic housing.

3 - Use APP® recommended tooling only. Alternate tools may adversely affect the performance of our connectors along with UL and CSA recognition.

4 - Has not been tested by UL.

IEC INFORMATION

| Connector Series | Configurations | Creepage / Clearance per IEC 60950-1 | Material Group |
|------------------|----------------|--------------------------------------|----------------|
| SB® 350 | Unmated | 5.66 mm | IIla |
| | Mated | 5.66 mm | |

PROTECTION

Touch Safety with Wire Contacts

IEC 60529 IP10 unmated



| ATTRIBUTES | SB® 350 |
|---|---|
| AMP Rating AC/DC | 350 |
| Voltage Rating AC/DC (Steady State) | 500 V AC/DC (Operational) |
| Breaking Capacity - AMP Rating / Cycles | 100 Amp / 10 cycles |
| Voltage Rating (Breaking Capacity) | 125 VDC |
| Finger Safety - Mated Only | IEC 60529 - IP20 |
| Wire Size Tested | 120 mm ² |
| Contact Series Tested | 908 |
| Climatic Testing (Cold, Heat & MFG) | IEC 60512 Test -11j, 11i & 11g |
| Cycle Life | IEC 60512 Test 9a - 5,000 Cycles |
| Mechanical Strength Impact | IEC 60512-5 @ 29.5 Inches - Dropped 8 Times |
| Temperature Range | -20 °C to 105 °C -4 °F to 221 °F |

SB® 350 ACCESSORIES

Cable Clamps *

Durable metal cable clamps securely hold cables to prevent accidental strain or pulls from dislodging wire or contacts from the housing. Cable clamps are recommended for solder terminated wires.

| Description | Cable Size | | Part Number |
|--------------------------------|-----------------------|-------------------|-------------|
| | Min / Max Inches O.D. | Min / Max mm O.D. | |
| Minimum Quantity | | | 10 |
| Bolt On for Discrete Conductor | 1.00 to 0.35 | 25.4 to 8.8 | 996G1 |

* Torque value 50 (in - lbs) / 5.6 (Nm)

NOTE: For assembly of clamp to housing only

The given wire O.D. information is an estimate. Cable clamps should be evaluated for performance with the actual wire to be used.

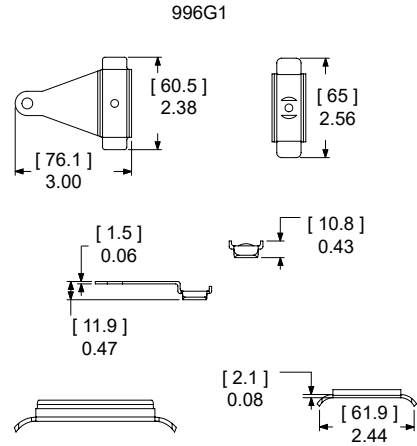

Handles *

Handles are made out of durable PC plastic. Hardware to attach to connector body included in kits.

| Description | Part Numbers | |
|--------------------|--------------|-------|
| Minimum Quantity | 100 | 25 |
| Gray Handle Kit | - | 995G2 |
| Red Handle Kit | - | 995G4 |
| Handle Only, Gray | 3-5074P1 | - |
| Handle Only, Red | 3-5074P3 | - |
| Handle Only, Black | 3-5074P5 | - |
| Hardware Bag | - | 106G7 |

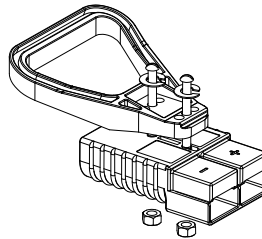

* Torque value 50 (in - lbs) / 5.6 (Nm)

NOTE: For assembly of clamp to housing only

Dust Cover

Prevents dust and dirt from entering the mating interface of the connector when unmated. NOTE: Not a Hermetic Seal.

| Description | Part Numbers | |
|------------------------------------|--------------|-------|
| Minimum Quantity | 500 | 50 |
| Dust Cover with Lanyard Strap, Red | 113890P3 | 134G3 |

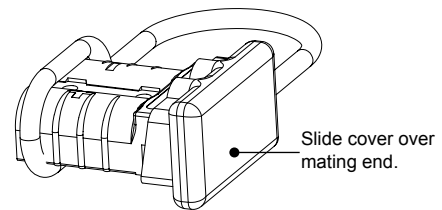

SB® 350 Lockout

Works with standard lockout - tagout equipment to prevent access to the mating interface of the connector. Made from durable PC plastic.

| Description | Part Number |
|--------------------------|---------------|
| Minimum Quantity | 25 |
| Red Lockout - Tagout Kit | SB350-LOCKOUT |

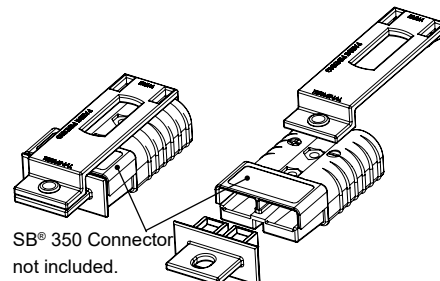

Manual Release Bracket - Mounting Side *

Works with the Locking Side to ease mating and unmating connectors.

| Description | Part Numbers | | |
|--------------------------|--------------|-------|-------|
| | 66 | 25 | 10 |
| Minimum Quantity | 66 | 25 | 10 |
| Bracket and Hardware Kit | - | - | 922G1 |
| Bracket Only | B00229P1 | - | - |
| Hardware Bag | - | 106G6 | - |

* Torque value 50 (in - lbs) / 5.6 (Nm)

NOTE: For assembly of brackets to housing only

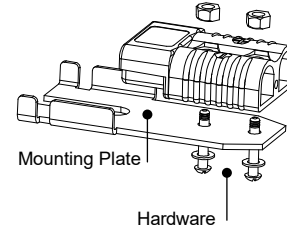

Manual Release Bracket - Locking Side with Cable Clamp *

Works with the Mounting Side to ease mating and unmating connectors.

| Description | Cable Size | | Part Number |
|---------------------------------------|--------------------------|----------------------|-------------|
| | Min / Max Inches O.D. | Min / Max mm O.D. | |
| Minimum Quantity | | | 10 |
| Bracket and Hardware Kit w/ Clamp Kit | 0.94 to 0.61 | 23.7 to 15.5 | 919 |

* Torque value 50 (in - lbs) / 5.6 (Nm)

NOTE: For assembly of bracket to housing only

The given wire O.D. information is an estimate. Cable clamps should be evaluated for performance with the actual wire to be used.

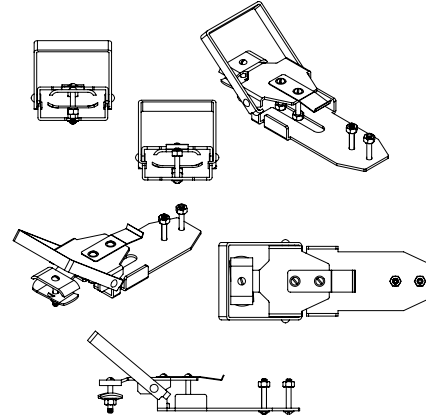

Manual Release Bracket - Locking Side no Cable Clamp *

Works with the Battery side to ease mating and unmating connectors.

| Description | Part Number |
|---------------------------------------|-------------|
| Minimum Quantity | 10 |
| Bracket and Hardware Kit No Clamp Kit | 919G1 |

* Torque value 50 (in lbs) / 5.6 (N - M)

NOTE: For assembly of bracket to housing only

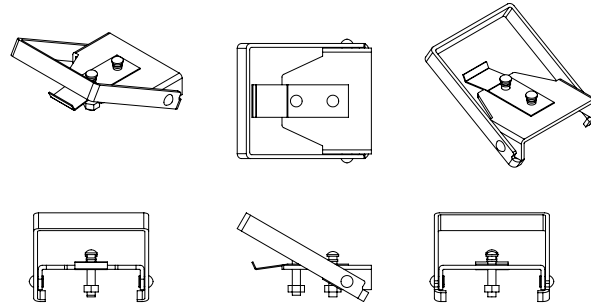

Reducing Bushings: for Use with Contact Part Number 907

Use with contact part number 907-BK to allow a smaller wire to be used with the connector. Electrical capability is derated with smaller wire.

| Contact Barrel Size | | Wire Size | | Part Numbers | |
|---------------------|------|-----------|-----------------|--------------|------|
| AWG | mm | AWG | mm ² | | |
| Minimum Quantity | | | | 500 | 100 |
| 2/0 | 67.4 | 1/0 | 53.5 | 5918-BK | 5918 |

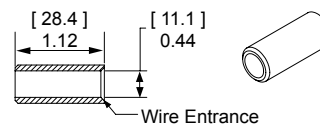

SB® Tooling Information

| Wire Size | | Loose Piece Part Number | Loose Piece Contact Crimp Tools | | | | | | | |
|----------------|-----------------|-------------------------|---------------------------------|----|----------------|--------|---------|--------|---------|------------------|
| AWG | mm ² | Silver Plating | Hand Tool | OR | Pneumatic Tool | + | Die | + | Locator | Number of Crimps |
| SB® 50 | | | | | | | | | | |
| 6 | 13.3 | 1307 | 1309G4 | | 1387G1 | | 1388G6 | | 1389G6 | Single |
| | | 5900 | | | | | | | | |
| 8 | 8.4 | 5952 | | | | | | | | |
| 10 to 12 | 5.3 to 3.3 | 5953 | | | | | | | | |
| | | 5915 | | | | | 1388G7 | | 1389G7 | |
| SB® 120 | | | | | | | | | | |
| 1 | 42.4 | 1323G1 | 1368 Series | | 1387G1 | | 1388G3 | | 1389G4 | Single |
| 2 | 33.6 | 1319 | | | | | | | | |
| 4 | 21.2 | 1319G4 | | | | | | | | |
| 6 | 13.3 | 1319G6 | | | | | 1388G4 | | | |
| SB® 175 | | | | | | | | | | |
| 1/0 | 53.5 | 1382 | 1368 Series | | 1387G2 | | 1303G13 | | 1304G32 | Double |
| 1 | 42.4 | 1347 | | | | | | | | |
| 2 | 33.6 | 1383 | | | | | | | | |
| 4 | 21.1 | 1384 | | | 1387G1 | 1388G4 | 1389G3 | Single | | |
| 6 | 13.3 | 1348 | | | | | | | | |
| SB® 350 | | | | | | | | | | |
| 350 mcm | 185 | 910 | 1368 Series | | N/A | | | | 1304G31 | Double |
| 300 mcm | 152 | 910 | | | | | | | | |
| 4/0 | 107.2 | 908 | | | | | | | | |
| 3/0 | 85 | 916 | | | | | | | | |
| 2/0 | 67.4 | 907 | | | | | | | | |
| 1/0 | 53.5 | 917 | | | | | | | | |

NOTE: See website for the most current information.

SB® 2/0 Tooling Information

| Wire Size | | Loose Piece Part Number | Loose Piece Contact Crimp Tools | | | | | | | |
|-----------|-----------------|-------------------------|---------------------------------|----|----------------|---|---------|---|---------|------------------|
| AWG | mm ² | Silver Plating | Hand Tool | OR | Pneumatic Tool | + | Die | + | Locator | Number of Crimps |
| 2/0 | 53.5 | 1328G1 | 1368 | | 1387G2 | | 1303G12 | | 1304G32 | Double |

NOTE: See website for the most current information.

SBE® 80 / SBO® 60 Connectors

Up to 80 Amps



SBE® and SBO® connectors build on the capability of the two pole SB® connectors by offering up to 8 auxiliary power / signal contacts along with an IEC 60950 touch safe housing. The center of the main connector features a connector holder for either: two PP15/45, two PPMX, or APP's innovative 1x4 auxiliary connector.

- **Touch Safe Interface**

Minimizes potential contact with live circuits per IEC 60950

- **Up to 8 Last Mate / First Break Auxiliaries**

Enables intelligent power switching, CAN and interlock loop circuitry, as well as power up to 20 amps per pole

- **Silver Plated Wire Contacts up to 4 (25 mm²)**

Allows UL rated currents up to 80 amps per pole

SBE® 80 / SBO® 60

SBE® 80 / SBO® 60 ORDERING INFORMATION

SBE® 80 / SBO® 60 Housings

The smallest size of SBE®, X, O style housing. SBE® 80 and SBO® 60 housings of the same Voltage Color-Code can be mated but is not recommended as it invalidates UL approvals for SBO® 60. SBO® 60 housings do not meet EN1175-1 requirements for industrial trucks.

| Description | SBE® 80 Part Numbers | | SBO® 60 Part Numbers | |
|-------------|----------------------|----------------------|----------------------|----------------------|
| | Minimum Quantity | | Minimum Quantity | |
| Yellow | 400 | SBE80YEL-BK SBE80YEL | 400 | SBO60YEL-BK SBO60YEL |
| Orange | | SBE80ORN-BK SBE80ORN | | SBO60ORN-BK SBO60ORN |
| Red | | SBE80RED-BK SBE80RED | | SBO60RED-BK SBO60RED |
| Gray | | SBE80GRA-BK SBE80GRA | N/A | N/A |
| White | | N/A N/A | SBO60WHT-BK | SBO60WHT |

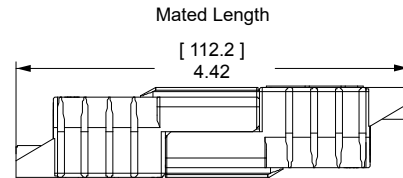

Side View

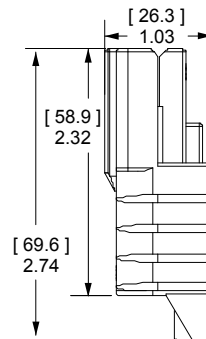

Top View

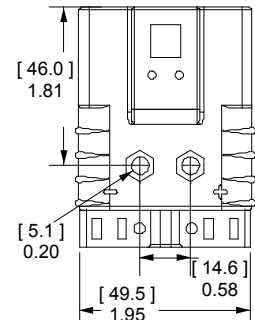

SBE® 80 / SBO® 60 Silver Plated Primary Power Wire Contacts

Use two silver plated contacts per housing for the best electrical performance and durability up to 10,000 mating cycles. See reducing bushings in accessory section for smaller wire size.

| AWG | mm ² | Mating Force | Loose Piece Part Numbers | | Dimensions | | | | |
|------------------|-----------------|--------------|--------------------------|----------|------------|------|-------|-----|--|
| | | | | | - A - | | - B - | | |
| | | | inches | mm | inches | mm | | | |
| Minimum Quantity | | | 1,000 | 100 | | | | | |
| 4 | 25 | Low | 1339G4-BK | 1339G4 * | 0.28 | 7.11 | 0.35 | 9.0 | |
| 6 | 16 | High | 1339G1-BK | 1339G1 * | 0.22 | 5.59 | 0.29 | 7.3 | |

* Sold as pairs. 2 parts shipped for every 1 part ordered.

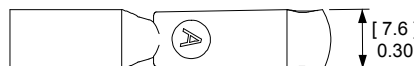
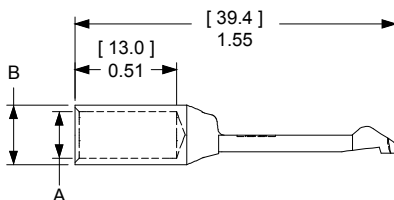

SBE® 80 / SBO® 60 CONNECTOR TEMPERATURE CHARTS - Temperature rise charts are based on a 25°C ambient temperature.

Current - Temperature Derating per IEC 60512-5-2 Test 5B

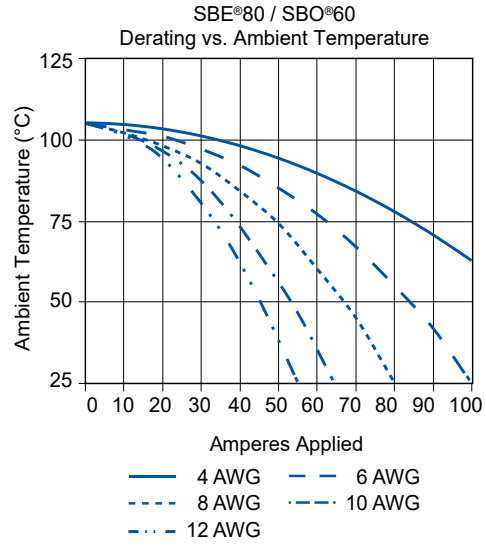
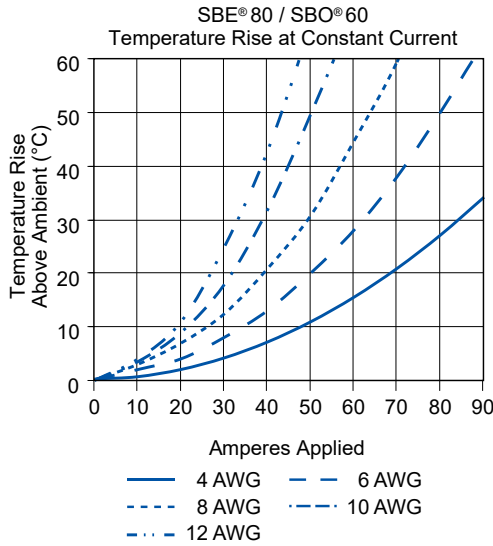

SBE® 80 / SBO® 60 CONNECTOR SPECIFICATIONS

ELECTRICAL

| Current Rating Amperes ¹ | SBO® 60 | SBE® 80 |
|--|----------------|------------------|
| Primary Power (6 AWG) | 70 | 80 |
| Powerpole® Auxiliary (12 AWG) | 20 | 20 |
| 1x4 Auxiliary (12 AWG) | 20 | 20 |
| PPMX Auxiliary (20 AWG) | 7 UL | 5 CSA |
| Voltage Rating AC/DC | UL 1977 | EN1175-1 |
| Primary Power | 600 | 150 ⁴ |
| Powerpole® Auxiliary | 600 | 150 ⁴ |
| 1x4 Auxiliary | 200 | |
| PPMX Auxiliary | 300 | |
| Dielectric Withstanding Voltage Primary Power | | |
| Volts AC | 2,200 | |
| Avg. Mated Contact Resistance Milliohms ¹ | | |
| 1 1/4" of 6 AWG wire | 0.200 | |
| Hot Plug Current Rating Amperes - 250 Cycles at 120V DC | | |
| Power | 60A | |
| Powerpole® Auxiliary | 30A | |
| 1x4 Auxiliary | 5A | |

Specifications continued on next page

MATERIALS**Housing**

| | |
|-------------------------------------|---------------------------|
| SBE® / SBO® & 1x4 Auxiliary Housing | Polycarbonate / PBT blend |
| Powerpole® Plastic Resin | Polycarbonate |
| Contact Retention Spring | Stainless Steel |

Housing Flammability Rating

| | |
|--------------------------|-----------------------------|
| UL94 | V-0 |
| Glow Wire - SBE® 80 Only | 960°C (GWFI) / 800°C (GWIT) |

Power & Powerpole® Contact

Silver Plated Copper Alloy

1x4 Auxiliary Contacts

| | |
|----------------|---------------------------------|
| Pin | Copper alloy, Au over Ni |
| Socket | BeCu, Au over Ni |
| Socket Body | Copper Alloy, Sn Bright Over Ni |
| Retention Clip | Stainless Steel |

PPMX Contacts

Gold Plated Copper Alloy

Contact Termination Methods

| |
|--------------------|
| Crimp ³ |
| Hand Solder |



NOTE 1: See IEC 60664-1 for working voltage.

NOTE 2: Amp ratings are stated per position and based on all positions being fully loaded.

1 - Based on: 105°C rated or better cable of the largest size. Properly calibrated APP® recommended tooling, and a 25°C ambient temperature. UL rating not to exceed the maximum operating temperature. CSA rating below a 30°C temperature rise. Only SBO® 60 has UL recognition.

2 - Limited by the thermal properties of the connector plastic housing.

3 - Use APP® recommended tooling only. Alternate tools may adversely affect the performance of our connectors along with UL and CSA recognition.

4 - Voltage capability of SBE® housings is identical to SBO®, but derated to meet EN1175-1 requirements.

MECHANICAL

| Wire Size Range | AWG | mm ² |
|--------------------|----------|-----------------|
| Power Contacts | 6 to 4 | 16 to 25 |
| Auxiliary Contacts | 24 to 10 | 0.25 to 5.3 |

Max. Wire Insulation Diameter

| | in. | mm |
|----------------------|-------|--------|
| Power Contacts | 0.440 | 11.200 |
| Powerpole® Auxiliary | 0.175 | 4.450 |
| 1x4 Auxiliary | 0.140 | 3.600 |

| Operating Temperature ² | °F | °C |
|------------------------------------|-------------|--------------|
| SBO® and SBE® Housings | -4° to 221° | -20° to 105° |

Mating Cycles No Load by Plating

| | Silver (Ag) | Gold (Au) |
|----------------------|-------------|-----------|
| Power Contacts | 10,000 | |
| Powerpole® Auxiliary | 10,000 | |
| 1x4 Auxiliary | | 10,000 |
| PPMX Auxiliary | | 5,000 |

Avg. Mating / Unmating Force

| | Lbf. | N |
|------------------------------|------|-------|
| Main Connector Housing | 16 | 70 |
| Per Powerpole® Connector | 5 | 22 |
| Per Contact in 1x4 Auxiliary | 0.7 | 3.0 |
| Per PPMX Housing | 4.50 | 20.00 |

Min. Contact / Spring Retention Force

| | Lbf. | N |
|------------------------|------|------|
| Power Standard Housing | 50 | 222 |
| Powerpole® Housing | 25 | 111 |
| 1x4 Auxiliary Housing | 10 | 44.5 |
| PPMX Housing | 12 | 53 |

IEC INFORMATION

| Connector Series | Configurations | Creepage / Clearance per IEC 60950-1 | Material Group |
|------------------|----------------|--------------------------------------|----------------|
| SBE® 80 | Unmated | 4.23 mm | IIla |
| | Mated | 7.9 mm | |

PROTECTION**Touch Safety Main Connector Housing**

| | |
|-----------|------|
| IEC 60950 | Pass |
| IEC 60529 | IP20 |



SBE® 80 / SBO® 60 ACCESSORIES

Cable Clamps

Clamps are made out the same chemical resistant PBT material that is used in the SBE® housings. Clamp holds the cable between the clamp piece and the connector housing. Screws must be ordered separately for part numbers starting with "113".

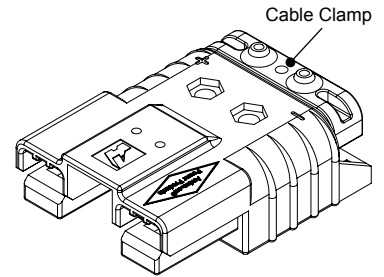

| Description | Part Numbers | | |
|----------------------------|--------------|--------------|----------------------------|
| Minimum Quantity | 100 | | 25 |
| Red Clamp and Hardware Kit | - | | SBE80CLPRED or SBO60CLPRED |
| Red Clamp Only | 113953P1 | | - |
| Screws (2 per clamp) | H1120P42 | (Individual) | - |

"T" Handle *

Handles are made out the same chemical resistant PBT material that is used in the SBE® housings. (2) screws and (2) nuts are required to attach each handle.

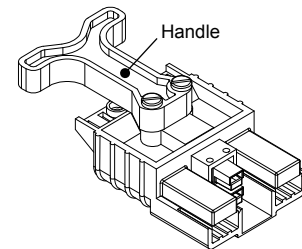

| Description | Part Numbers | | |
|-----------------------------|--------------|----------|----------------------------|
| Minimum Quantity | 500 | 100 | 25 |
| Red Handle and Hardware Kit | - | | SBE80HDLRED or SBO60HDLRED |
| Red Handle Only | 113952P1 | | - |
| Hardware Bag | - | | 105G13 |
| M5 x 35mm Screws | - | 113715P4 | - |
| M5 Nut | - | 113716P3 | - |

* Torque value 12 (in - lbs) / 1.4 (Nm)
NOTE: For assembly of clamp to housing only

Powerpole® Auxiliary

Powerpole® auxiliary connectors are rated up to 30 amps 600 volts and can be used for auxiliary power, control or sensing. The auxiliary kit includes (1) each black and red Standard Powerpole® housing, (2) contacts, (2) zip cable straps, and (2) retaining pins.

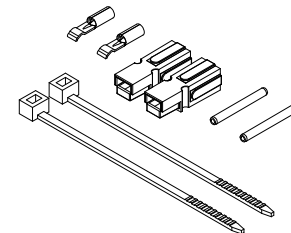

| Description | Part Numbers | |
|--------------------------|--------------|------|
| Minimum Quantity | 200 | 25 |
| Powerpole® Auxiliary Kit | - | 6344 |
| Black Powerpole® Housing | 1327G6 | - |
| Red Powerpole® Housing | 1327 | - |
| 16 to 12 Contact | 1331 | - |
| Retaining Pin | - | - |

NOTE: Finger proof PP15/45 housings should not be used for auxiliary contacts.

1x4 Auxiliary Connector

The unique 1x4 auxiliary connector allows up to 4 auxiliary circuits up to 20 amps 200 volts each in SBE®, SBO®, & SBX® housings. The genderless design holds two each of the gold plated pin & socket contacts. This innovation allows the very durable and cost effective design of SBE®, O, X connectors to substitute for DIN 43589-1 applications where 4 auxiliary contacts are required. Multiple pin lengths allow the further benefit of sequencing between circuits. (2) Retaining pins are required to hold the auxiliary housing in place. Auxiliary Kits include (1) Auxiliary Housing, (2) Standard Length Pin Contacts, and (2) Socket Contacts, (2) Retaining Pins and (1) Retaining Clip.

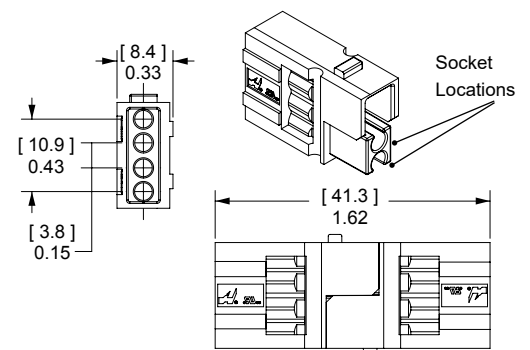

| Description | AWG | mm² | Part Numbers | | |
|-----------------------|--------------------------|-------------|--------------|-------|-------|
| Minimum Quantity | | | 1,000 | 250 | 25 |
| 1x4 Auxiliary Kit | 12 | 4 | - | - | 441G3 |
| 1x4 Auxiliary Kit | 16 to 14 | 1.5 to 2.5 | - | - | 441G1 |
| 1x4 Auxiliary Kit | 20 to 16 | 0.75 to 1.5 | - | - | 441G2 |
| 1x4 Auxiliary Housing | Contacts Sold Separately | | 3-5956P1 | 444G1 | - |

Pin Contacts for 1x4 Auxiliary Connector

Gold plated contacts are available in 4 lengths to allow sequencing of circuits.

| Description | AWG | mm ² | Part Numbers | |
|-------------------------|----------|-----------------|--------------|-----------------|
| Minimum Quantity | | | 500 | 50 |
| Standard Length 7.7 mm | 12 | 2.5 | PM16P12S30 | PM16P12S30-50 |
| | 16 to 14 | 1.0 to 1.5 | PM16P1416S30 | PM16P1416S30-50 |
| | 20 to 16 | 0.75 to 1.0 | PM16P1620S30 | PM16P1620S30-50 |
| | 24 to 20 | 0.50 to 0.75 | PM16P2024S30 | PM16P2024S30-50 |
| Pre-Mate 9.3 mm | 12 | 2.5 | PM16P12A30 | - |
| | 16 to 14 | 1.0 to 1.5 | PM16P1416A30 | - |
| | 20 to 16 | 0.75 to 1.0 | PM16P1620A30 | - |
| | 24 to 20 | 0.50 to 0.75 | PM16P2024A30 | - |
| Post-Mate 6.4 mm | 12 | 2.5 | PM16P12C30 | - |
| | 16 to 14 | 1.0 to 1.5 | PM16P1416C30 | - |
| | 20 to 16 | 0.75 to 1.0 | PM16P1620C30 | - |
| | 24 to 20 | 0.50 to 0.75 | PM16P2024C30 | - |

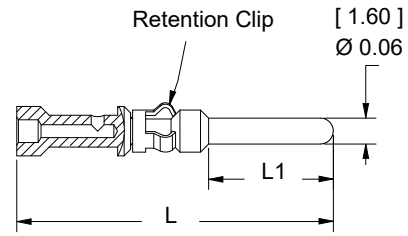

| Auxiliary Pin Contact Lengths | - L - | | - L1 - | |
|-------------------------------|-------|------|--------|-----|
| | in. | mm | in. | mm |
| Standard Length 7.7 mm | 0.77 | 19.6 | 0.30 | 7.7 |
| Pre-Mate 9.3 mm | 0.83 | 21.2 | 0.37 | 9.3 |
| Post-Mate 6.4 mm | 0.72 | 18.3 | 0.25 | 6.4 |

Socket Contacts for 1x4 Auxiliary Connector

Selectively gold plated contacts offer low resistance and durability up to 10,000 mating cycles.

| Description | AWG | mm ² | Part Numbers | |
|-------------------------|----------|-----------------|--------------|-----------------|
| Minimum Quantity | | | 500 | 50 |
| Socket Contact | 12 | 2.5 | PM16S12S32 | PM16S12S32-50 |
| | 16 to 14 | 1.0 to 1.5 | PM16S1416S32 | PM16S1416S32-50 |
| | 20 to 16 | 0.75 to 1.0 | PM16S1620S32 | PM16S1620S32-50 |
| | 24 to 20 | 0.50 to 0.75 | PM16S2024S32 | PM16S2024S32-50 |

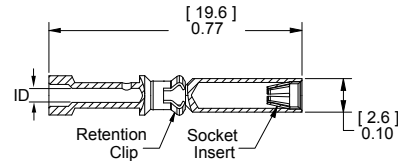

| Auxiliary Socket Contacts Crimp Barrel ID | | |
|---|------|-----|
| Wire Gauge | in. | mm. |
| 24 to 20 | 0.04 | 1.1 |
| 20 to 16 | 0.07 | 1.7 |
| 16 to 14 | 0.08 | 2.1 |
| 12 | 0.10 | 2.6 |

PPMX Auxiliary Connector

The PPMX auxiliary connector allows up to 8 auxiliary circuits to be used in the SBE®, SBO®, & SBX® housings. There are 4 auxiliary circuits per PPMX connector and two PPMX housings fit into the auxiliary port in the main connector housing. Rated up to 7 amps 300 volts per contact, the genderless design holds two each gold plated pin & socket contacts. This innovation allows the very durable and cost effective equipment design of SBE®, O, X connectors to be used for applications requiring up to 8 battery monitoring or vehicle communication circuits. (2) Retaining pins or (1) Retaining clip is required to hold the auxiliary housing in place.

Auxiliary Kits include (1) Auxiliary Housing, (2) Pin Contacts, and (2) Socket Contacts.

| Description | AWG | mm ² | Part Numbers | | |
|-------------------------|--------------------------|-----------------|--------------|------------|-----------|
| Minimum Quantity | | | 1,000 | 100 | 25 |
| PPMX Auxiliary Kit | 24 to 20 | 0.50 to 0.25 | - | 4850G6 | - |
| 1x4 Auxiliary Housing | Contacts Sold Separately | | 4827G6-BK | - | 4827G6 |

* No extraction tool required for contact removal.

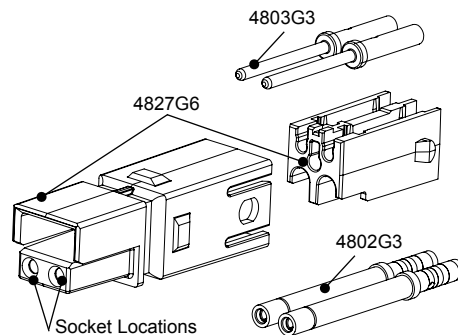

Pin & Socket Contacts for PPMX Auxiliary Connector

Gold plated contacts are ideal for signal or low power use with durability up to 5,000 mating cycles.

| Description | AWG | mm ² | Part Numbers | |
|------------------|----------|-----------------|--------------|--------|
| Minimum Quantity | | | 2,000 | 50 |
| Pin Contacts | 24 to 20 | 0.50 to 0.25 | 4803G3-BK | 4803G3 |
| Socket Contacts | 24 to 20 | 0.50 to 0.25 | 4802G3-BK | 4802G3 |

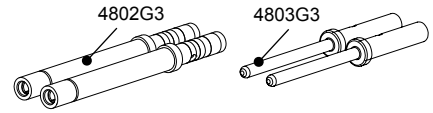

NOTE: Contacts sold individually, not sold as a set of two.

SBE® Air Tubes

Air tubes fit into SBE® housings to allow electrolyte circulation while charging the battery. Genderless tube design allows the same part to be used on both sides. (2) Retaining pins are required to hold the air tube in place. Retaining pins are included in Air Tube Kit.

| Description | Part Numbers | |
|---------------------|--------------|--------|
| Minimum Quantity | 500 | 25 |
| Air Tube Kit, Black | - | 6396G1 |
| Air Tube Only | 3-5798P1 | - |

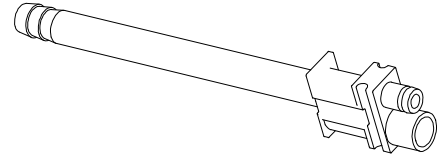

Retaining Pins

Retaining pins are used to hold accessories in the auxiliary port in SBE®, SBO®, & SBX® housings. Dimension "B" is +/- 0.015 in or 0.38 mm.

| Description | Part Numbers | | Dimensions | | | |
|-----------------------|--------------|-------|---------------|-------------|--------|-------|
| | | | - A - | | - B - | |
| | | | inches | mm | inches | mm |
| Minimum Quantity | 1,000 | 100 | | | | |
| For SBE® 80 & SBO® 60 | 110G9-BK | 110G9 | 0.093 / 0.099 | 2.36 / 2.51 | 0.85 | 21.59 |

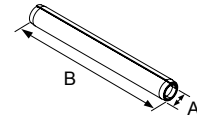

Zip Cable Straps

Zip cable straps are used to secure auxiliary wires to the side of the main power cables.

| Description | Part Number |
|------------------|-------------|
| Minimum Quantity | 1,000 |
| White | H1835P3 |

Use cable ties to secure auxiliary contact leads to one of the main cables.

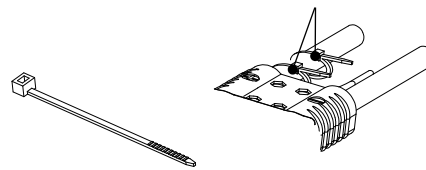

Reducing Bushings

Use with contact part number 1339G1 to allow a smaller wire to be used with the connector. Electrical capability is derated with smaller wire.

| Contact Barrel Size | | Wire Size | | Part Numbers | | | Dimensions | | | |
|---------------------|-----------------|-----------|---------------------|--------------|---------|------|------------|------|------------|-------|
| AWG | mm ² | AWG | mm ² | | | | - ID - | | - Length - | |
| | | | | | | | inches | mm | Inches | mm |
| Minimum Quantity | | | | 3,000 | 1,000 | 100 | | | | |
| 6 | 13.3 | 8 | 8.4 mm ² | - | 5912-BK | 5912 | 0.18 | 4.57 | 0.45 | 11.43 |
| 6 | 13.3 | 12 to 10 | 3.3 to 5.3 | 5910-BK | - | 5910 | 0.14 | 3.56 | 0.47 | 11.94 |
| 6 | 13.3 | 16 to 14 | 1.3 to 2.1 | 5913-BK | - | 5913 | 0.09 | 2.29 | 0.47 | 11.94 |

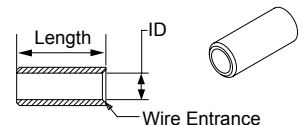

SBE® 160 / SBX® 175 Connectors

Up to 175 Amps

SBX® and SBE® connectors can integrate up to 8 auxiliary power / signal contacts along with the two primary power circuits. SBE® connectors feature an IEC 60950 touch safe housing molded from a chemical resistant PBT / PC blend resin. SBX® are molded from a rugged PC resin and are rated IP20 per IEC 60529.

SBE® 160



- **Touch Safe Interface**

Minimizes potential contact with live circuits per IEC 60950 & IEC 60529

- **Up to 8 Last Mate / First Break Auxiliaries**

Enables intelligent power switching, CAN and interlock loop circuitry, as well as power up to 20 amps per pole

- **Color-coded Mechanical Voltage Keys**

Like all Multipole connectors, the SBE® and SBX® offer an easy way to identify circuits and protect against cross mating

SBE® 160 / SBX® 175

SBE® 160 / SBX® 175 ORDERING INFORMATION

SBE® 160 / SBX® 175 Housings

The middle size of SBE®, X, O style housing. SBE® housings are molded from a chemical resistant PBT. SBX® housings are molded from PC. SBE® 160 and SBX® 175 housings of the same Voltage Color-Code can be mated (except yellow) but is not recommended as it invalidates UL approvals. SBX® 175 housings do not meet EN1175-1 requirements for industrial trucks.

| Description | SBE® 160 Part Numbers | | SBX® 175 Part Numbers | |
|------------------|-----------------------|---------|-----------------------|--------|
| Minimum Quantity | 100 | 25 | 100 | 25 |
| Yellow | 2-8170G4 | E6383G1 | 2-7251G4 | 6383G1 |
| Orange | 2-8170G3 | E6382G1 | 2-7251G3 | 6382G1 |
| Red | 2-8170G5 | E6385G1 | 2-7251G5 | 6385G1 |
| Gray | 2-8170G1 | E6380G1 | 2-7251G1 | 6380G1 |
| Blue | 2-8170G2 | E6381G1 | 2-7251G2 | 6381G1 |
| Green | 2-8170G7 | E6390G1 | 2-7251G7 | 6390G1 |
| Black | 2-8170G14 | E6392G1 | N/A | N/A |

* Yellow SBE® 160 and SBX® 175 housings are NOT intermateable.

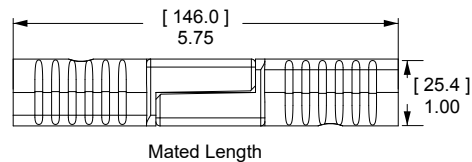
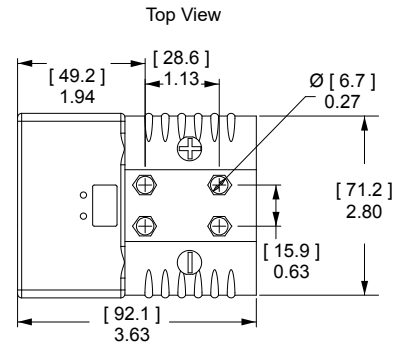

SBE® 160 / SBX® 175 Silver Plated Primary Power Wire Contacts

Use two silver plated contacts per housing for the best electrical performance and durability up to 10,000 mating cycles. See reducing bushings in accessory section for smaller wires.

| AWG | mm² | Loose Piece Part Numbers | | Dimensions - A - inches mm | |
|------------------|-----|--------------------------|----------|----------------------------------|------|
| Minimum Quantity | | 500 | 50 | | |
| 1/0 | 50 | 6384G1-BK | 6384G1 * | 0.44 | 11.1 |
| 2 | 35 | 6384G2-BK | 6384G2 * | 0.38 | 9.7 |

* Sold as pairs. 2 parts shipped for every 1 part ordered.

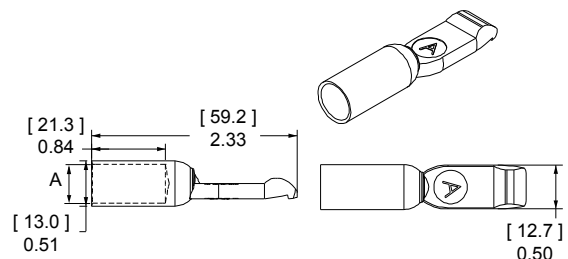

SBE® 160 / SBX® 175 CONNECTOR TEMPERATURE CHARTS - Temperature rise charts are based on a 25°C ambient temperature.

Current - Temperature Derating per IEC 60512-5-2 Test 5B

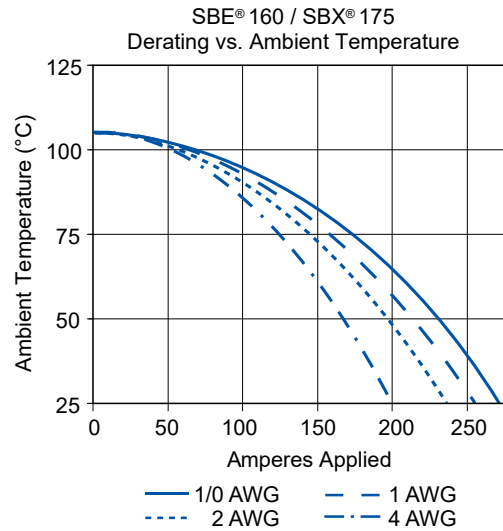
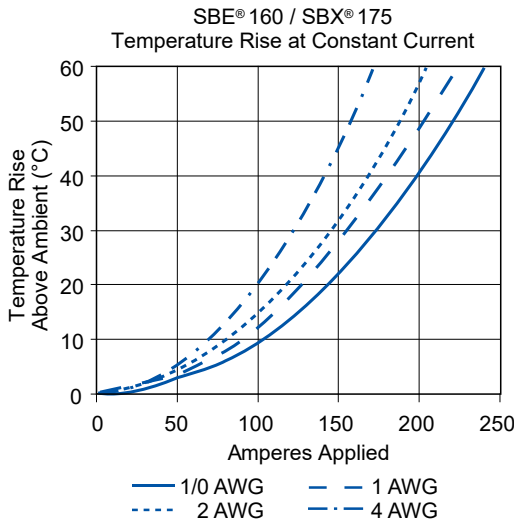

SBE® 160 / SBX® 175 CONNECTOR SPECIFICATIONS

| ELECTRICAL SBE® 160 / SBX® 175 Connectors - Up to 280A | | | |
|---|-------------|-------|------------------|
| Electrical | SBE® / SBX® | | SBE® Only |
| Current Rating Amperes ¹ | UL | CSA | EN1175-1 |
| Primary Power (1/0) | 280 | 175 | 160 |
| Powerpole® Auxiliary | 20 | 20 | N/A |
| 1x4 Auxiliary (12 AWG) | 20 | 20 | N/A |
| PPMX Auxiliary (20 AWG) | 7 | 5 | N/A |
| Voltage Ratings | | | |
| Powerpole® Auxiliary | 600 | 600 | 150 ⁴ |
| 1x4 Auxiliary (12 AWG) | 600 | 600 | N/A |
| Dielectric Withstanding Voltage | | | |
| Volts AC | 2,200 | 2,000 | 2,000 |
| Avg. Mated Contact Resistance ¹ | | | |
| 6" of 1/0 AWG Wire | 0.1 | 0.1 | |
| UL Hot Plug Current Rating Amperes - 250 Cycles at 120V DC | | | |
| Power | 100 | 100 | |
| Powerpole® Auxiliary | 30 | 30 | |
| 1x4 Auxiliary | 5A | 5A | |

| MECHANICAL | | |
|--|--------------------|-----------------------|
| Wire Size Range | AWG | mm² |
| Power Contacts | 10 to 1/0 | 5.3 to 53.5 |
| Auxiliary Contacts | 24 to 10 | 0.25 to 5.3 |
| Max. Wire Insulation Diameter | in. | mm |
| Power Contacts | 0.600 | 15.200 |
| Powerpole® Auxiliary | 0.175 | 4.450 |
| 1x4 Auxiliary | 0.140 | 3.600 |
| Operating Temperature ² | °F | °C |
| SBX® and SBE® Housings | -4° to 221° | -20° to 105° |
| Mating Cycles No Load by Plating | Silver (Ag) | Gold (Au) |
| Power Contacts | 10,000 | |
| Powerpole® Auxiliary | 10,000 | |
| 1x4 Auxiliary | | 10,000 |
| PPMX Auxiliary | | 5,000 |
| Avg. Mating / Unmating Force | Lbf. | N |
| Main Connector Housing | 30 | 134 |
| Per Powerpole® Connector | 5.00 | 22.00 |
| Per Contact in 1x4 Auxiliary | 0.70 | 3.00 |
| Per PPMX Housing | 4.50 | 20.00 |
| Min. Contact / Spring Retention Force | Lbf. | N |
| Power Standard Housing | 120 | 533.7 |
| Powerpole® Housing | 25 | 111 |
| 1x4 Auxiliary Housing | 10 | 44.5 |
| PPMX Housing | 12 | 53 |

Specifications continued on next page

MATERIALS

Housing

| | |
|-----------------------------------|---------------------------|
| SBX® and Powerpole® Plastic Resin | Polycarbonate |
| SBE® and 1x4 Auxiliary Housing | Polycarbonate / PBT Blend |
| Contact Retention Spring | Stainless Steel |

Housing Flammability Rating

| | |
|----------------------------|-----------------------------|
| UL94 | V-0 |
| Glow Wire- SBE® 160 Only | 960°C (GWFI) / 850°C (GWIT) |
| Power & Powerpole® Contact | Silver Plated Copper Alloy |

1x4 Auxiliary Contacts

| | |
|----------------|---------------------------------|
| Pin | Copper Alloy, Au Over Ni |
| Socket | BeCu, Au Over Ni |
| Socket Body | Copper Alloy, Sn Bright Over Ni |
| Retention Clip | Stainless Steel |

PPMX Contacts

Gold Plated Copper Alloy

Contact Termination Methods

| |
|--------------------|
| Crimp ³ |
| Hand Solder |



NOTE 1: See IEC 60664-1 for working voltage.

NOTE 2: Amp ratings are stated per position and based on all positions being fully loaded.

- 1 - Based on: 105°C rated or better cable of the largest size. Properly calibrated APP® recommended tooling, and a 25°C ambient temperature. UL rating not to exceed the maximum operating temperature. CSA Rating below a 30°C temperature rise.
- 2 - Limited by the thermal properties of the connector plastic housing.
- 3 - Use APP® recommended tooling only. Alternate tools may adversely affect the performance of our connectors along with UL and CSA recognition.
- 4 - Voltage capability of SBE® housing is identical to SBX®, but derated to meet EN1175-1 requirements.

IEC INFORMATION

| Connector Series | Configurations | Creepage / Clearance per IEC 60950-1 | Material Group |
|------------------|----------------|--------------------------------------|----------------|
| SBE® 160 | Unmated | 6.1 mm | IIla |
| | Mated | 11.6 mm | |

PROTECTION

Touch Safety Main Connector Housing

| | | |
|-----------|---------------|--------------|
| IEC 60950 | SBE® 160 Only | Pass |
| IEC 60529 | SBX® 175 Only | IP20 unmated |



| ATTRIBUTES | SBE® 160 |
|---|---|
| AMP Rating AC/DC | 160 Amp |
| Voltage Rating AC/DC (Steady State) | 600 V AC/DC (Operational) |
| Breaking Capacity - AMP Rating / Cycles | 160 Amp / 10 Cycles |
| Voltage Rating (Breaking Capacity) | 220 VDC |
| FINGER Safety - Mated / Unmated | IEC 60529 - IP20 |
| Wire Size Tested | 50 mm ² |
| Contact Series Tested | 6384G1 |
| Climatic Testing (Cold, Heat & MFG) | IEC 60512 Test -11j, 11i & 11g |
| Cycle Life | IEC 60512 Test 9a - 5,000 Cycles |
| Mechanical Strength Impact | IEC 60512-5 @ 29.5 Inches-dropped 8 times |
| Temperature Range | -20 °C to 105 °C -4 °F to 221 °F |

SBE® 160 / SBX® 175 ACCESSORIES

Cable Clamps *

Durable metal clamps adapt to a wide range of cable sizes.

| Description | Cable Size | | Part Number |
|------------------|-----------------------|-------------------|-------------|
| | Min / Max Inches O.D. | Min / Max mm O.D. | |
| Minimum Quantity | | | 25 |
| Cable Clamp Kit | 0.62 to 0.22 | 15.7 to 5.6 | 945G2 |

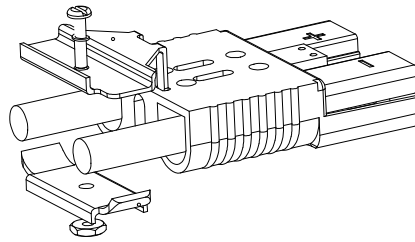

* Torque value 30 (in - lbs) / 3.4 (Nm)

NOTE: For assembly of clamp to housing only

The given wire O.D. information is an estimate. Cable clamps should be evaluated for performance with the actual wire to be used.

Handles *

Handles are made out of durable PC plastic. Hardware to attach to connector body included in kits.

| Description | Part Numbers | |
|--------------------|--------------|-------|
| Minimum Quantity | 100 | 25 |
| Gray Handle Kit | 995G1-APP | 995G1 |
| Red Handle Kit | 995G3-APP | 995G3 |
| Handle Only, Gray | 3-5074P1 | - |
| Handle Only, Red | 3-5074P3 | - |
| Handle Only, Black | 3-5074P5 | - |
| Hardware Bag | - | 105G8 |

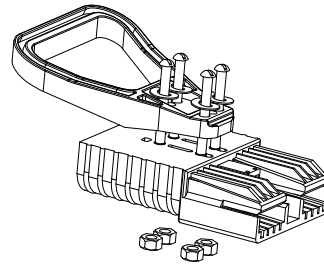

* Torque value 30 (in - lbs) / 3.4 (Nm)

NOTE: For assembly of clamp to housing only

Powerpole® Auxiliary

Powerpole® auxiliary connectors are rated up to 30 amps 600 volts and can be used for auxiliary power, control or sensing. The auxiliary kit includes (1) each black and red Standard Powerpole® housing, (2) contacts, (2) zip cable straps, and (2) retaining pins. (1) Retaining clip can be substituted for (2) retaining pins.

| Description | Part Numbers | |
|--------------------------|--------------|------|
| Minimum Quantity | 200 | 25 |
| Powerpole® Auxiliary Kit | - | 6344 |
| Black Powerpole® Housing | 1327G6 | - |
| Red Powerpole® Housing | 1327 | - |
| 16 to 12 AWG Contact | 1331 | - |

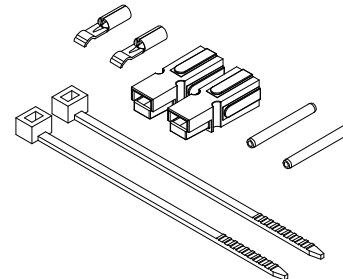

NOTE: Finger proof PP15/45 housings should not be used for auxiliary contacts.

1x4 Auxiliary Connector

The unique 1x4 auxiliary connector allows up to 4 auxiliary circuits up to 20 amps 150 volts each in SBE®, SBO®, & SBX® housings. The genderless design holds two each of the gold plated pin & socket contacts. This innovation allows the very durable and cost effective design of SBE®, O, X connectors to substitute for DIN 43589-1 applications where 4 auxiliary contacts are required. Multiple pin lengths allow the further benefit of sequencing between circuits. (2) Retaining pins or (1) Retaining clip is required to hold the auxiliary housing in place. Auxiliary Kits include (1) Auxiliary Housing, (2) Standard Length Pin Contacts, (2) Socket Contacts, (2) Retaining Pins and (1) Retaining Clip.

| Description | AWG | mm ² | Part Numbers | | |
|-----------------------|--------------------------|-----------------|--------------|-------|-------|
| Minimum Quantity | | | 1,000 | 250 | 25 |
| 1x4 Auxiliary Kit | 12 | 4 | - | - | 441G3 |
| 1x4 Auxiliary Kit | 16 to 14 | 1.5 to 2.5 | - | - | 441G1 |
| 1x4 Auxiliary Kit | 20 to 16 | 0.75 to 1.5 | - | - | 441G2 |
| 1x4 Auxiliary Housing | Contacts Sold Separately | | 3-5956P1 | 444G1 | - |

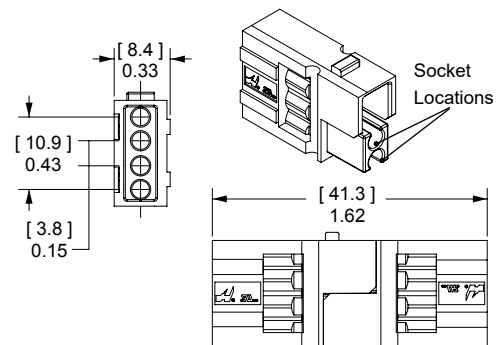

Pin Contacts for 1x4 Auxiliary Connector

Gold plated contacts are available in 4 lengths to allow sequencing of circuits.

| Description | AWG | mm ² | Part Numbers | |
|-------------------------|----------|-----------------|--------------|-----------------|
| Minimum Quantity | | | 500 | 50 |
| Standard Length 7.7 mm | 12 | 2.5 | PM16P12S30 | PM16P12S30-50 |
| | 16 to 14 | 1.0 to 1.5 | PM16P1416S30 | PM16P1416S30-50 |
| | 20 to 16 | 0.75 to 1.0 | PM16P1620S30 | PM16P1620S30-50 |
| | 24 to 20 | 0.50 to 0.75 | PM16P2024S30 | PM16P2024S30-50 |
| Pre-Mate 9.3 mm | 12 | 2.5 | PM16P12A30 | - |
| | 16 to 14 | 1.0 to 1.5 | PM16P1416A30 | - |
| | 20 to 16 | 0.75 to 1.0 | PM16P1620A30 | - |
| | 24 to 20 | 0.50 to 0.75 | PM16P2024A30 | - |
| Post-Mate 6.4 mm | 12 | 2.5 | PM16P12C30 | - |
| | 16 to 14 | 1.0 to 1.5 | PM16P1416C30 | - |
| | 20 to 16 | 0.75 to 1.0 | PM16P1620C30 | - |
| | 24 to 20 | 0.50 to 0.75 | PM16P2024C30 | - |

| Auxiliary Pin Contact Lengths | - L - | | - L1 - | |
|-------------------------------|-------|------|--------|-----|
| | in. | mm | in. | mm |
| Standard Length 7.7 mm | 0.77 | 19.6 | 0.30 | 7.7 |
| Pre-Mate 9.3 mm | 0.83 | 21.2 | 0.37 | 9.3 |
| Post-Mate 6.4 mm | 0.72 | 18.3 | 0.25 | 6.4 |

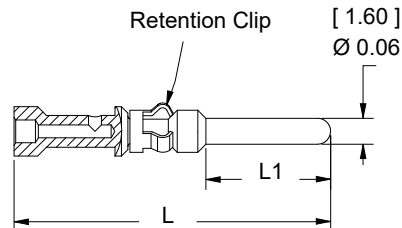

Socket Contacts for 1x4 Auxiliary Connector

Selectively gold plated contacts offer low resistance and durability up to 10,000 mating cycles.

| Description | AWG | mm ² | Part Numbers | |
|-------------------------|----------|-----------------|--------------|-----------------|
| Minimum Quantity | | | 500 | 50 |
| Socket Contact | 12 | 2.5 | PM16S12S32 | PM16S12S32-50 |
| | 16 to 14 | 1.0 to 1.5 | PM16S1416S32 | PM16S1416S32-50 |
| | 20 to 16 | 0.75 to 1.0 | PM16S1620S32 | PM16S1620S32-50 |
| | 24 to 20 | 0.50 to 0.75 | PM16S2024S32 | PM16S2024S32-50 |

Auxiliary Socket Contacts Crimp Barrel ID

| Wire Gauge | in. | mm. |
|------------|------|-----|
| 24 to 20 | 0.04 | 1.1 |
| 20 to 16 | 0.07 | 1.7 |
| 16 to 14 | 0.08 | 2.1 |
| 12 | 0.10 | 2.6 |

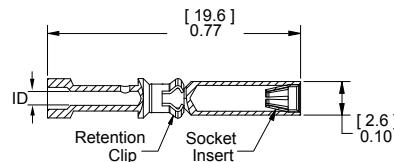

PPMX Auxiliary Connector

The PPMX auxiliary connector allows up to 8 auxiliary circuits to be used in the SBE®, SBO®, & SBX® housings. There are 4 auxiliary circuits per PPMX connector and two PPMX housings fit into the auxiliary port in the main connector housing. Rated up to 7 amps 300 volts per contact, the genderless design holds two each gold plated pin & Socket contacts. This innovation allows the very durable and cost effective design of SBE®, O, X connectors to be used for applications requiring up to 8 battery monitoring or equipment vehicle communication circuits. (2) Retaining pins or (1) Retaining clip is required to hold the auxiliary housing in place.

Auxiliary Kits includes: (1) Auxiliary Housing, (2) Pin Contacts, and (2) Socket Contacts.

| Description | AWG | mm ² | Part Numbers | | |
|-------------------------|--------------------------|-----------------|--------------|------------|-----------|
| Minimum Quantity | | | 1,000 | 100 | 25 |
| PPMX Auxiliary Kit | 24 to 20 | 0.50 to 0.25 | - | 4850G6 | - |
| 1x4 Auxiliary Housing | Contacts Sold Separately | | 4827G6-BK | - | 4827G6 |

* No extraction tool required for contact removal.

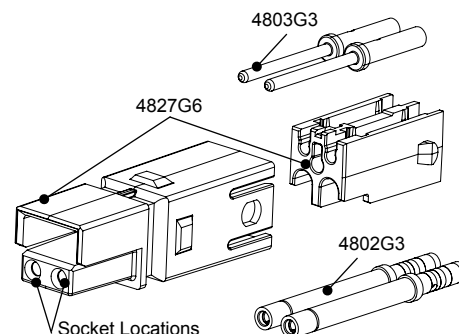

Pin & Socket Contacts for PPMX Auxiliary Connector

Gold plated contacts are ideal for signal or low power use with durability up to 5,000 mating cycles.

| Description | AWG | mm ² | Part Numbers | |
|------------------|----------|-----------------|--------------|--------|
| Minimum Quantity | | | 2,000 | 50 |
| Pin Contacts | 24 to 20 | 0.50 to 0.25 | 4803G3-BK | 4803G3 |
| Socket Contacts | 24 to 20 | 0.50 to 0.25 | 4802G3-BK | 4802G3 |

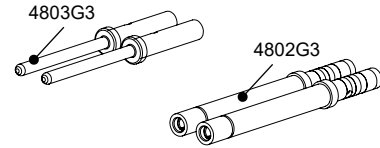

SBE® Air Tubes

Air tubes fit into SBE® housings to allow electrolyte circulation while charging the battery. Genderless tube design allows the same part to be used on both sides. (2) Retaining pins or (1) Retaining clip is required to hold the air tube in place. Retaining pins are included in Air Tube Kit.

| Description | Part Numbers | |
|---------------------|--------------|--------|
| Minimum Quantity | 500 | 25 |
| Air Tube Kit, Black | - | 6396G1 |
| Air Tube Only | 3-5798P1 | - |

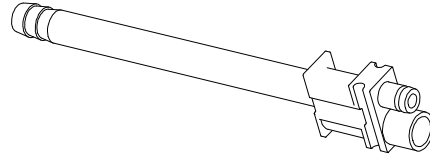

Retaining Clip

Retaining clips can be used in place of two retaining pins to hold auxiliary connectors or air tubes. Allows easier removal of auxiliary modules.

| Description | Part Number |
|-------------------------|-------------|
| Minimum Quantity | 100 |
| For SBE® 160 & SBX® 175 | 2-8675P2 |

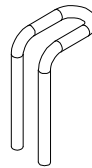

Retaining Pins

Retaining pins are used to hold accessories in the auxiliary port in SBE®, SBO®, & SBX® housings. Dimension "B" is +/- 0.015 in or 0.38 mm.

| Description | Part Numbers | | Dimensions | | | |
|-------------------------|--------------|-------|---------------|-------------|--------|-------|
| | | | - A - | | - B - | |
| | inches | mm | inches | mm | inches | mm |
| Minimum Quantity | 1,000 | 100 | | | | |
| For SBE® 160 & SBX® 175 | 110G9-BK | 110G9 | 0.093 / 0.099 | 2.36 / 2.51 | 0.85 | 21.59 |

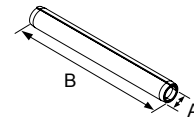

Zip Cable Straps

Zip cable straps are used to secure auxiliary wires to the side of the main power cables.

| Description | Part Number |
|------------------|-------------|
| Minimum Quantity | 1,000 |
| White | H1835P3 |

Use cable ties to secure auxiliary contact leads to one of the main cables.

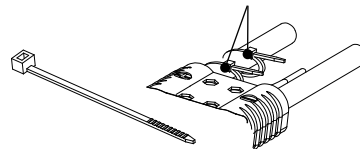

Manual Release - Battery Side *

Works with the Charger / Truck side to ease mating and unmating connectors.

| Description | Part Numbers | |
|--------------------------|--------------|-------|
| Minimum Quantity | 88 | 25 |
| Bracket and Hardware Kit | - | 993G2 |
| Battery Bracket Only | 111961P2 | - |
| Hardware Bag | - | 105G1 |

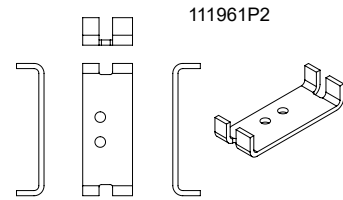
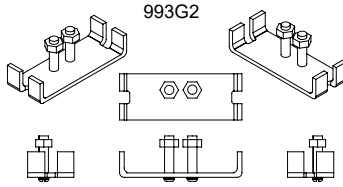

* Torque value 30 (in - lbs) / 3.4 (Nm)

*NOTE: For assembly of bracket to housing only

Manual Release - Charger / Truck Side *

Works with the Battery side to ease mating and unmating connectors.

| Description | Part Numbers | |
|--------------------------|--------------|-------|
| Minimum Quantity | 60 | 25 |
| Bracket and Hardware Kit | - | 994G2 |
| Bracket / Lever Only | B00511G2 | - |
| Hardware Bag | - | 105G1 |

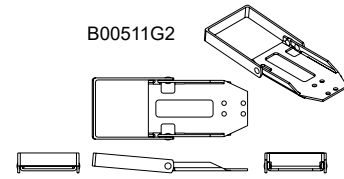
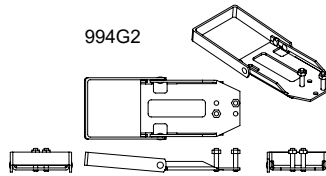

* Torque value 30 (in - lbs) / 3.4 (Nm)

*NOTE: For assembly of bracket to housing only

Reducing Bushings: for Use with Contact Part Number 6384G1

Use with contact part number 6384G1-BK to allow a smaller wire to be used with the connector. Electrical capability is derated with smaller wire.

| Contacts Barrel Size AWG mm ² | Wire Size | | Part Numbers | | | | Dimensions - ID - inches mm | |
|---|-----------|-----------------|--------------|---------|---------|------|-----------------------------------|------|
| | AWG | mm ² | 1,500 | 1,000 | 500 | 100 | | |
| 1/0 53.5 | 1 | 42.4 | - | - | 5687-BK | 5687 | 0.39 | 9.91 |
| 1/0 53.5 | 2 | 33.6 | 5690-BK | - | - | 5690 | 0.34 | 8.64 |
| 1/0 53.5 | 4 | 21.2 | - | 5693-BK | - | 5693 | 0.27 | 6.86 |
| 1/0 53.5 | 6 | 13.3 | - | 5663-BK | - | 5663 | 0.22 | 5.59 |
| 1/0 53.5 | 10 to 8 | 5.3 - 8.4 | 5648-BK | - | - | 5648 | 0.19 | 4.83 |

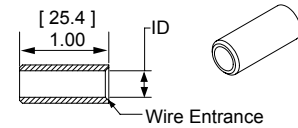

Reducing Bushings: for Use with Contact Part Number 6384G2

Use with contact part number 6384G2-BK to allow a smaller wire to be used with the connector. Electrical capability is derated with smaller wire.

| Contact Barrel Size | Wire Size | Part Numbers | |
|---------------------|--------------------|--------------|------|
| Minimum Quantity | | 1,000 | 100 |
| 35 mm ² | 16 mm ² | 5920-BK | 5920 |

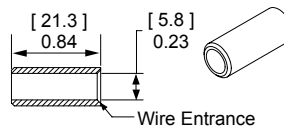

SBE® 320 / SBX® 350 Connectors

Up to 550 Amps



SBE® and SBX® connectors can integrate up to 8 auxiliary power / signal contacts along with the two primary power circuits. Sequencing within auxiliary positions is possible using the 4 pin lengths available in the 1x4 auxiliary connector. SBE® and SBX® offer touch safe housings.

- **Silver Plated Wire Contacts up to 350 mcm (185 mm²)**
Allows low resistance UL rated currents up to 550 amps per pole
- **Up to 8 Auxiliaries**
Enables intelligent power switching, CAN and interlock loop circuitry, as well as power up to 20 amps per pole. Auxiliaries are all Last-mate/ First-break relative to power contacts.

SBE® 320 / SBX® 350 ORDERING INFORMATION

SBE® 320 / SBX® 350 Housings

The largest size of SBE®, X, O style housing. SBE® housings are molded from a chemical resistant PBT. SBX® housings are molded from PC. SBE® 320 and SBX® 350 housings of the same Voltage Color-Code cannot be mated. SBX® 350 housings do not meet EN1175-1 requirements for industrial trucks.

| Description | SBE® 320 Part Numbers | | SBX® 350 Part Numbers | |
|-------------|-----------------------|-------|-----------------------|------|
| | 100 | 25 | 100 | 25 |
| Yellow | 2-8171G6 | E6362 | 2-7249G6 | 6362 |
| Orange | 2-8171G7 | E6339 | 2-7249G7 | 6339 |
| Red | 2-8171G3 | E6352 | 2-7249G3 | 6352 |
| Gray | 2-8171G1 | E6350 | 2-7249G1 | 6350 |
| Blue | 2-8171G2 | E6351 | 2-7249G2 | 6351 |
| Green | 2-8171G4 | E6353 | 2-7249G4 | 6353 |
| Black | 2-8171G5 | E6361 | 2-7249G5 | 6361 |
| Brown | 2-8171G8 | E6336 | N/A | N/A |
| Purple | 2-8171G9 | E6349 | N/A | N/A |

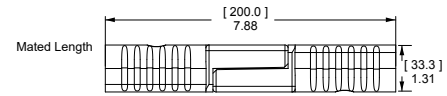
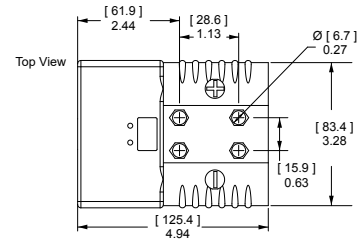

SBE® 320 / SBX® 350 Silver Plated Primary Power Wire Contacts

Silver plated contacts offer superior electrical performance and durability up to 10,000 mating cycles. See reducing bushings in accessory section for smaller wires.

| AWG | mm ² | Loose Piece Part Numbers | | | Dimensions | | | | | | | |
|------------------|-----------------|--------------------------|---------|--------|------------|-------|--------|-------|--------|-------|--------|-------|
| | | | | | - A - | | - B - | | - C - | | - D - | |
| Minimum Quantity | | 200 | 150 | 50 | inches | mm | inches | mm | inches | mm | inches | mm |
| 300/350 mcm | 150 | - | 6358-BK | 6358 * | 3.03 | 76.96 | 0.88 | 22.20 | 0.75 | 19.05 | 1.25 | 31.80 |
| 4/0 | 120 | 6356-BK | - | 6356 * | 3.10 | 78.74 | 0.75 | 19.05 | 0.64 | 16.26 | 1.25 | 31.80 |
| 3/0 | 95 | 6355-BK | - | 6355 * | 3.10 | 78.74 | 0.70 | 17.78 | 0.58 | 14.73 | 1.25 | 31.80 |
| 2/0 | 70 | 6354-BK | - | 6354 * | 3.10 | 78.74 | 0.64 | 16.26 | 0.49 | 12.45 | 1.25 | 31.80 |
| 2 | 35 | 6394-BK | - | 6394 * | 3.10 | 78.74 | 0.51 | 12.95 | 0.38 | 9.50 | 1.25 | 31.80 |

* Sold as pairs. 2 parts shipped for every 1 part ordered.

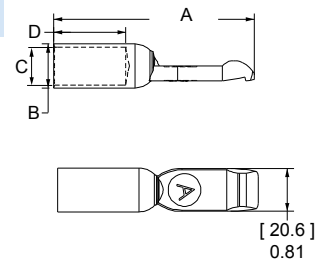

SBE® 320 DIN Standard Silver Plated Primary Power Wire Contacts

Crimp barrel O.D. are compliant with DIN standard tooling. Will also fit into SBX® 350 housings. Not recommended for cross mating with above typical contacts for SBE® & SBX®.

| AWG | mm ² | Loose Piece Part Numbers | | Dimensions | | | | | | | |
|------------------|-----------------|--------------------------|----------|------------|-------|--------|-------|--------|-------|--------|-------|
| | | | | - A - | | - B - | | - C - | | - D - | |
| Minimum Quantity | | 200 | 50 | inches | mm | inches | mm | inches | mm | inches | mm |
| 3/0 | 95 | 1341G3-BK | 1341G3 * | 2.89 | 73.41 | 0.78 | 19.81 | 0.59 | 14.99 | 0.94 | 23.88 |
| 2/0 | 70 | 1341G2-BK | 1341G2 * | 2.74 | 69.60 | 0.68 | 17.27 | 0.51 | 12.95 | 0.79 | 20.07 |
| 1/0 | 50 | 1341G1-BK | 1341G1 * | 2.65 | 67.31 | 0.57 | 14.48 | 0.43 | 10.92 | 0.79 | 20.07 |

* Sold as pairs. 2 parts shipped for every 1 part ordered.

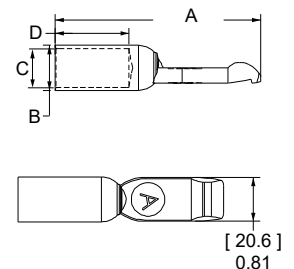

SBE® 320 / SBX® 350 CONNECTOR TEMPERATURE CHARTS - Temperature rise charts are based on a 25°C ambient temperature.

Current - Temperature Derating per IEC 60512-5-2 Test 5B

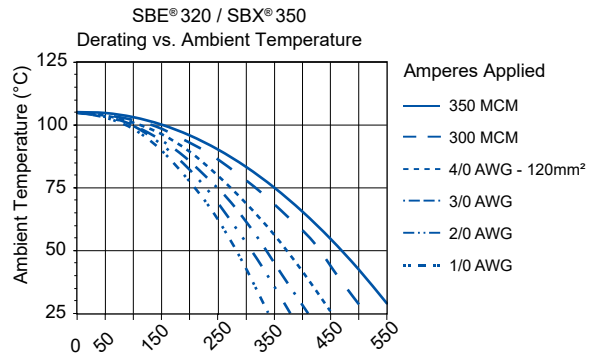
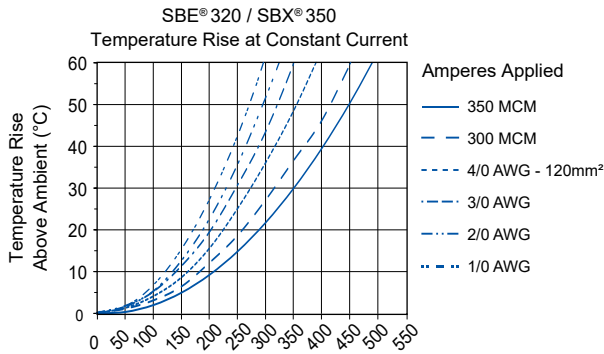

SBE® 320 / SBX® 350

SBE® 320 / SBX® 350 CONNECTOR SPECIFICATIONS

| ELECTRICAL | SBX® & SBE® | | SBE® Only |
|--|-------------|------------|------------------|
| Current Rating Amperes¹ | UL | CSA | EN1175-1 |
| Primary Power (350 MCM) | 550 | 350 | 320 |
| Powerpole® Auxiliary (12 AWG) | 20 | 20 | N/A |
| 1x4 Auxiliary (12 AWG) | 20 | 20 | N/A |
| PPMX (20 AWG) | 5 | 5 | N/A |
| Voltage Rating AC/DC | | | |
| Primary Power (350 MCM) | 600 | | 150 ⁴ |
| Powerpole® Auxiliary (12 AWG) | 600 | | 150 ⁴ |
| 1x4 Auxiliary (12 AWG) | 600 | | N/A |
| PPMX (20 AWG) | 600 | | N/A |
| Dielectric Withstanding Voltage | | | |
| Volts AC | 2,200 | | |
| * Average Mated Contact Resistance milliohms | | | |
| 2 1/2 " 350 MCM | 0.05 | | |

| MATERIALS | | |
|--|---------------------------|------------------------------|
| Housings | | |
| SBX® and Powerpole® Auxiliary Housings | Polycarbonate | |
| SBE®, PPMX and 1x4 Auxiliary Housings | Polycarbonate / PBT blend | |
| Housing Flammability Rating | UL | IEC (SBE® Only) |
| SBX® / SBE® | 94 V-0 | 960°C (GWFI) 850°C (GWIT) |
| Contact Materials | | |
| Power Contacts | Au Plated Copper | |
| Powerpole® Auxiliary | Au or Sn - Copper Alloy | |
| 1x4 Auxiliary Contacts | | |
| Pin | Au Over Ni - Copper Allow | |
| Socket | Au Over Ni - BeCu | |
| Socket Body | Sn Over Ni, Copper Alloy | |
| Retention Clip | Stainless Steel | |
| PPMX Contacts | Gold Plated Copper Alloy | |

* Not UL rated

Contact Terminations³ - Crimp or Hand Solder

| MECHANICAL | | |
|---|---------------------|-----------------------|
| Wire Size Range | AWG | mm² |
| Power Contacts | 1/0 to 350 MCM | 53.5 to 185 |
| Auxiliary Contacts | 24 to 10 AWG | 0.25 to 5.3 |
| Max Wire Insulation Diameter | in | mm |
| Power Contact | 0.82 * | 20.8 * |
| Powerpole® Auxiliary | 0.175 | 4.45 |
| 1x4 Auxiliary | 0.14 | 3.6 |
| PPMX Auxiliary | 0.09 | 2.29 |
| Operating Temperature ² | °F | °C |
| SBX® Housing with all Auxiliary | -4 to 221 | -20 to -105 |
| SBE® Housing | -40 to 221 | -40 to 105 |
| SBX® Housing with Powerpole® Auxiliary Housings | -4 to 221 | -20 to -105 |
| SBE® Housing with 1x4 and PPMX Auxiliaries | -40 to 221 | -40 to 105 |
| Mating Cycles | Silver / Tin | Gold |
| Power Contacts | 10,000 | N/A |
| Powerpole® Auxiliary | 10,000 / 1500 | N/A |
| 1x4 Auxiliary | N/A | 10,000 |
| PPMX Auxiliary | N/A | 5,000 |
| Average Mating | LBF | N |
| Main Connector Housing | 37 | 165 |
| Per Powerpole® Connector | 5 | 22 |
| Per 1x4 Auxiliary Housing | 0.7 | 3 |
| Per PPMX Housing | 4.5 | 20 |
| Min Contact / Spring Retention Force | 150 | 667 |
| Powerpole® Housing | 25 | 111 |
| 1x4 Auxiliary Housing | 10 | 44.5 |
| PPMX Housing | 12 | 53 |
| Min Contact / Spring Retention Force | 150 | 667 |
| Powerpole® Housing | 25 | 111 |
| 1x4 Auxiliary Housing | 10 | 44.5 |
| PPMX Housing | 12 | 53 |
| 1x4 Auxiliary Housing | 10 | 44.5 |
| PPMX Housing | 12 | 53 |

IEC INFORMATION

| Connector Series | Configurations | Creepage / Clearance per IEC 60950-1 | Material Group |
|------------------|----------------|--------------------------------------|----------------|
| SBE® 320 | Unmated | 5.6 mm | IIIa |
| | Mated | 24.7 mm | |

| ATTRIBUTES | SBE® 320 |
|--|---|
| AMP Rating AC/DC | 320 Amp |
| Voltage Rating AC/DC (Steady State) | 600 V AC/DC (Operational) |
| Breaking Capacity - AMP Rating / Cycles | 275 Amp / 10 Cycles |
| Voltage Rating (Breaking Capacity) | 220 VDC |
| FINGER Safety - Mated / Unmated | IEC 60529 - IP20 |
| Wire Size Tested | 120 mm ² |
| Contact Series Tested | 6356 |
| Climatic Testing (Cold, Heat & MFG) | IEC 60512 Test -11j, 11i & 11g |
| Cycle Life | IEC 60512 Test 9a - 5,000 Cycles |
| Mechanical Strength Impact | IEC 60512-5 @ 29.5 Inches Dropped 8 Times |
| Temperature Range | -20°C to 105°C -4°F to 221°F |

PROTECTION

Touch Safety Main Connector Housing

| | | |
|-----------|---------------------|------|
| IEC 60950 | SBE® 320 Only | Pass |
| IEC 60529 | SBE® 320 & SBX® 350 | IP20 |



Note 1: See IEC60664-1 for working voltage

Note 2: Amp ratings are stated per position and based on all positions being fully loaded

1 - Based on 195°C rated or better cable of the largest size. Properly calibrated APP® recommended tooling and 25°C ambient temperature

2 - limited by thermal properties of the connector plastic housing

3 - USE APP® recommended tooling only. Alternate tools may adversely affect performance of our connectors along with UL and CSA recognition

4 - Voltage capability of SBE® housings is identical to SBX® but derated to meet EN1175-1 requirements

* Refer to assembly instructions for using 300 MCM and 350 MCM wire

SBE® 320 / SBX® 350 ACCESSORIES

Cable Clamps

Durable metal clamps adapt to a wide range of cable sizes. Cable clamp kit includes clamp top and bottom as well as the hardware bag.

| Description | Cable Size | | Part Number |
|------------------|-----------------------|-------------------|-------------|
| | Min / Max Inches O.D. | Min / Max mm O.D. | |
| Minimum Quantity | | | 25 |
| Cable Clamp Kit | 0.85 to 0.67 | 21.6 to 17.1 | 911G2 |

The given wire O.D. information is an estimate. Cable clamps should be evaluated for performance with the actual wire to be used.

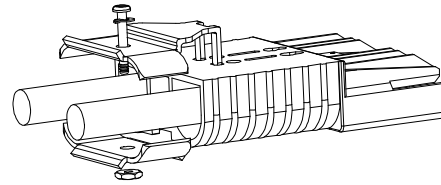

Handles *

Handles are made out of durable PC plastic. Hardware to attach to connector body included in kits.

| Description | Part Numbers | |
|--------------------|--------------|-------|
| Minimum Quantity | 100 | 25 |
| Gray Handle Kit | 995G2-APP | 995G2 |
| Red Handle Kit | 995G4-APP | 995G4 |
| Handle Only, Gray | 3-5074P1 | - |
| Handle Only, Red | 3-5074P3 | - |
| Handle Only, Black | 3-5074P5 | - |
| Hardware Bag | - | 106G7 |

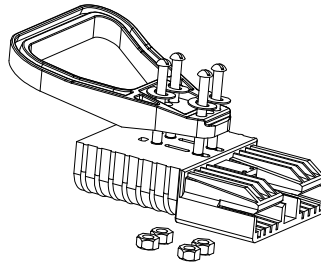

* Torque value 50 (in - lbs) / 5.6 (Nm)

NOTE: For assembly of clamps to housing only

Powerpole® Auxiliary

Powerpole® auxiliary connectors are rated up to 30 amps 600 volts and can be used for auxiliary power, control or sensing. The auxiliary kit includes (1) each black and red standard Powerpole® housing, (2) Contacts, (2) Zip Cable Straps, and (2) Retaining Pins. (1) Retaining Clip can be substituted for (2) Retaining Pins.

| Description | Part Numbers | |
|---|--------------|--------|
| Minimum Quantity | 200 | 25 |
| Powerpole® Auxiliary Kit 16 to 12 AWG Contact | - | 6305G1 |
| Powerpole® Auxiliary Kit 20 to 16 AWG Contact | - | 6310G1 |
| Black Powerpole® Housing | 1327G6 | - |
| Red Powerpole® Housing | 1327 | - |
| 16 to 12 AWG Contact | 1331 | - |
| 20 to 16 AWG Contact | 1332 | - |

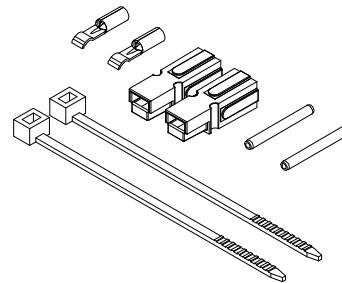

NOTE: Finger proof PP15/45 housings should not be used for auxiliary contacts.

1x4 Auxiliary Connector

The unique 1x4 auxiliary connector allows up to 4 auxiliary circuits up to 20 amps 150 volts each in SBE®, SBO®, & SBX® housings. The genderless design holds two each of the gold plated pin & socket contacts. This innovation allows the very durable and cost effective design of SBE®, O, X connectors to substitute for DIN 43589-1 applications where 4 auxiliary contacts are required. Multiple pin lengths allow the further benefit of sequencing between circuits. (2) Retaining Pins or (1) Retaining Clip is required to hold the auxiliary housing in place. Auxiliary Kits include (1) Auxiliary Housing, (2) Standard Length Pin Contacts, (2) Socket Contacts, (2) Retaining Pins and (1) Retaining Clip.

| Description | AWG | mm ² | Part Numbers | | |
|-----------------------|--------------------------|-----------------|--------------|-------|-------|
| Minimum Quantity | | | 1,000 | 250 | 25 |
| 1x4 Auxiliary Kit | 12 | 4 | - | - | 440G3 |
| 1x4 Auxiliary Kit | 16 to 14 | 1.5 to 2.5 | - | - | 440G1 |
| 1x4 Auxiliary Kit | 20 to 16 | 0.75 to 1.5 | - | - | 440G2 |
| 1x4 Auxiliary Housing | Contacts Sold Separately | | 3-5956P1 | 444G1 | - |

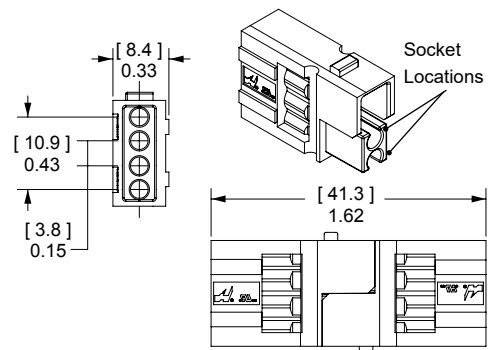

Pin Contacts for 1x4 Auxiliary Connector

Gold plated contacts are available in 4 lengths to allow sequencing of circuits.

| Description | AWG | mm ² | Part Numbers | |
|------------------------|----------|-----------------|--------------|-----------------|
| Minimum Quantity | | | 500 | 50 |
| Standard Length 7.7 mm | 12 | 2.5 | PM16P12S30 | PM16P12S30-50 |
| | 16 to 14 | 1.0 to 1.5 | PM16P1416S30 | PM16P1416S30-50 |
| | 20 to 16 | 0.75 to 1.0 | PM16P1620S30 | PM16P1620S30-50 |
| | 24 to 20 | 0.50 to 0.75 | PM16P2024S30 | PM16P2024S30-50 |
| Pre-Mate 9.3 mm | 12 | 2.5 | PM16P12A30 | PM16P12A30-50 |
| | 16 to 14 | 1.0 to 1.5 | PM16P1416A30 | PM16P1416A30-50 |
| | 20 to 16 | 0.75 to 1.0 | PM16P1620A30 | PM16P1620A30-50 |
| | 24 to 20 | 0.50 to 0.75 | PM16P2024A30 | PM16P2024A30-50 |
| Post-Mate 6.4 mm | 12 | 2.5 | PM16P12C30 | PM16P12C30-50 |
| | 16 to 14 | 1.0 to 1.5 | PM16P1416C30 | PM16P1416C30-50 |
| | 20 to 16 | 0.75 to 1.0 | PM16P1620C30 | PM16P1620C30-50 |
| | 24 to 20 | 0.50 to 0.75 | PM16P2024C30 | PM16P2024C30-50 |

| Auxiliary Pin Contact Lengths | - L - | | - L1 - | |
|-------------------------------|-------|------|--------|-----|
| | in. | mm | in. | mm |
| Standard Length 7.7 mm | 0.77 | 19.6 | 0.30 | 7.7 |
| Pre-Mate 9.3 mm | 0.83 | 21.2 | 0.37 | 9.3 |
| Post-Mate 6.4 mm | 0.72 | 18.3 | 0.25 | 6.4 |

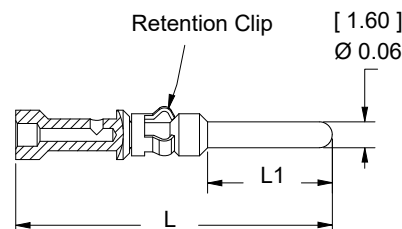

Socket Contacts for 1x4 Auxiliary Connector

Selectively gold plated contacts offer low resistance and durability up to 10,000 mating cycles.

| Description | AWG | mm ² | Part Numbers | |
|------------------|----------|-----------------|--------------|-----------------|
| Minimum Quantity | | | 500 | 50 |
| Socket Contact | 12 | 2.5 | PM16S12S32 | PM16S12S32-50 |
| | 16 to 14 | 1.0 to 1.5 | PM16S1416S32 | PM16S1416S32-50 |
| | 20 to 16 | 0.75 to 1.0 | PM16S1620S32 | PM16S1620S32-50 |
| | 24 to 20 | 0.50 to 0.75 | PM16S2024S32 | PM16S2024S32-50 |

Auxiliary Socket Contacts Crimp Barrel ID

| Wire Gauge | in. | mm. |
|------------|------|-----|
| 24 to 20 | 0.04 | 1.1 |
| 20 to 16 | 0.07 | 1.7 |
| 16 to 14 | 0.08 | 2.1 |
| 12 | 0.10 | 2.6 |

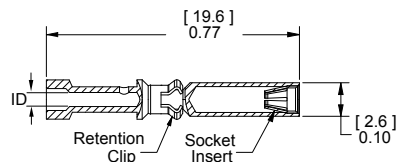

SBE® Air Tubes

Air tubes fit into SBE® housings to allow electrolyte circulation while charging the battery. Genderless tube design allows the same part to be used on both sides. (2) Retaining Pins or (1) Retaining Clip is required to hold the air tube in place. Retaining Pins are included in Air Tube Kit.

| Description | Part Numbers | |
|---------------------|--------------|--------|
| Minimum Quantity | 500 | 25 |
| Air Tube Kit, Black | - | 6396G1 |
| Air Tube Only | 3-5798P1 | - |

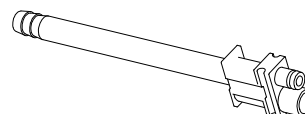

PPMX Auxiliary Connector

The PPMX auxiliary connector allows up to 8 auxiliary circuits to be used in the SBE®, SBO®, & SBX® housings. There are 4 auxiliary circuits per PPMX connector and two PPMX housings fit into the auxiliary port in the main connector housing. Rated up to 7 amps 300 volts per contact, the genderless design holds two each gold plated pin & socket contacts. This innovation allows the very durable and cost effective design of SBE®, O, X connectors to be used for applications requiring up to 8 battery monitoring or equipment vehicle communication circuits. (2) Retaining Pins or (1) Retaining Clip is required to hold the auxiliary housing in place.

Auxiliary Kits includes: (1) Auxiliary Housing, (2) Pin Contacts, and (2) Socket Contacts.

| Description | AWG | mm ² | Part Numbers | | |
|-----------------------|--------------------------|-----------------|--------------|--------|--------|
| Minimum Quantity | | | 1,000 | 100 | 25 |
| PPMX Auxiliary Kit | 24 to 20 | 0.50 to 0.25 | - | 4850G6 | - |
| 1x4 Auxiliary Housing | Contacts Sold Separately | | 4827G6-BK | - | 4827G6 |

* No extraction tool required for contact removal.

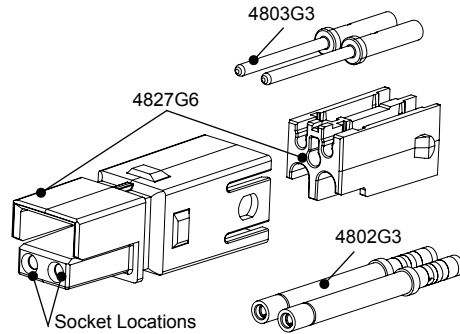

Pin & Socket Contacts for PPMX Auxiliary Connector

Gold plated contacts are ideal for signal or low power use with durability up to 5,000 mating cycles.

| Description | AWG | mm ² | Part Numbers | |
|------------------|----------|-----------------|--------------|--------|
| Minimum Quantity | | | 2,000 | 50 |
| Pin Contacts | 24 to 20 | 0.50 to 0.25 | 4803G3-BK | 4803G3 |
| Socket Contacts | 24 to 20 | 0.50 to 0.25 | 4802G3-BK | 4802G3 |

Retaining Clip

Retaining clips can be used in place of two retaining pins to hold auxiliary connectors or air tubes. Allows easier removal of auxiliary modules.

| Description | Part Number |
|-------------------------|-------------|
| Minimum Quantity | 100 |
| For SBE® 320 & SBX® 350 | 2-8675P1 |

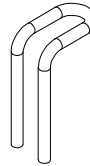

Retaining Pins

Retaining pins are used to hold accessories in the auxiliary port in SBE®, SBO®, & SBX® housings. Dimension "B" is +/- 0.015 in or 0.38 mm.

| Description | Part Number | Dimensions | | | |
|-------------------------|-------------|---------------|-------------|--------|-------|
| | | - A - | | - B - | |
| | | inches | mm | inches | mm |
| Minimum Quantity | 1,000 | | | | |
| For SBE® 320 & SBX® 350 | 110G59-BK | 0.093 / 0.103 | 2.36 / 2.62 | 1.000 | 25.40 |

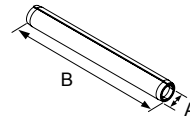

Zip Cable Straps

Zip cable straps are used to secure auxiliary wires to the side of the main power cables.

| Description | Part Number |
|------------------|-------------|
| Minimum Quantity | 1,000 |
| White | H1835P3 |

Use cable ties to secure auxiliary contact leads to one of the main cables.

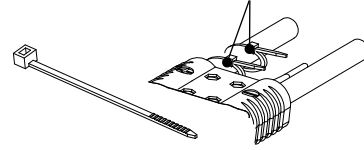

Manual Release - Battery Side *

Works with the Charger / Truck side to ease mating and unmating connectors.

| Description | Part Numbers | |
|--------------------------|--------------|-------|
| Minimum Quantity | 72 | 25 |
| Bracket and Hardware Kit | - | 993G1 |
| Battery Bracket Only | 111961P1 | - |
| Hardware Bag | - | 106G6 |

* Torque value 50 (in - lbs) / 5.6 (Nm)

NOTE: For assembly of bracket to housing only

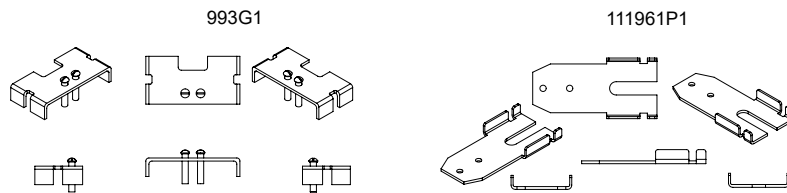

Manual Release - Charger/ Truck Side *

Works with the Battery side to ease mating and unmating connectors.

| Description | Part Numbers |
|--------------------------|--------------|
| Minimum Quantity | 25 |
| Bracket and Hardware Kit | 994G1 |
| Bracket / Lever Only | B00511G4 |
| Hardware Bag | 106G6 |

* Torque value 50 (in lbs) / 5.6 (Nm)

NOTE: For assembly of bracket to housing only

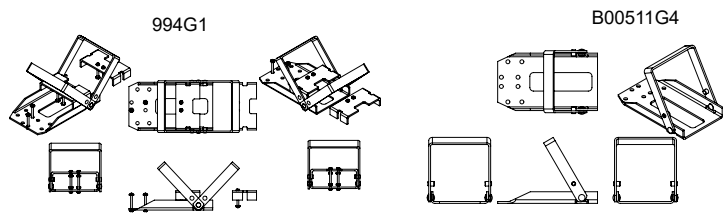

Reducing Bushings: for Use with Contact Part Number 6354 and Bushing Part Number 5918

Use with contact part number 6354-BK and bushing part number 5918-BK to allow a smaller wire to be used with the connector. Electrical capability is derated with smaller wire.

| Bushings Part Number 5918 | | Wire Size | | Part Numbers | | | | Dimensions - ID - | |
|---------------------------|------|---------------------|------------|--------------|---------|---------|------|-------------------|------|
| Barrel Size | | AWG mm ² | | | | | | inches | mm |
| Minimum Quantity | | | | 1,500 | 1,000 | 500 | 100 | | |
| 1/0 | 53.5 | 1 | 42.4 | - | - | 5687-BK | 5687 | 0.39 | 9.91 |
| 1/0 | 53.5 | 2 | 33.6 | 5690-BK | - | - | 5690 | 0.34 | 8.64 |
| 1/0 | 53.5 | 4 | 21.2 | - | 5693-BK | - | 5693 | 0.27 | 6.86 |
| 1/0 | 53.5 | 6 | 13.3 | - | 5663-BK | - | 5663 | 0.22 | 5.59 |
| 1/0 | 53.5 | 10 to 8 | 5.3 to 8.4 | 5648-BK | - | - | 5648 | 0.19 | 4.83 |

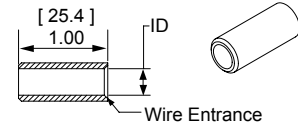

Reducing Bushings: for Use with Contact Part Number 6354

Use with contact part number 6354-BK to allow a smaller wire to be used with the connector. Electrical capability is derated with smaller wire.

| Contact Barrel Size / Wire Size | Part Number |
|---|--------------|
| Minimum Quantity | 500 100 |
| 2/0 AWG (67.4 mm ²) 1/0 AWG (53.5 mm ²) | 5918-BK 5918 |

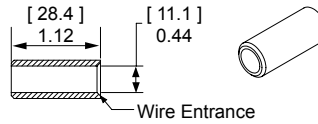

SBE® 320 / SBX® 350

Reducing Bushings: for Use with Contact Part Number 6394

Use with contact part number 6394-BK to allow a smaller wire to be used with the connector. Electrical capability is derated with smaller wire.

| Contact Barrel Size / Wire Size | Part Numbers | Dimensions - ID - |
|---------------------------------------|--------------|-------------------|
| | | inches mm |
| Minimum Quantity | 1,000 100 | |
| 35 mm ² 16 mm ² | 5920-BK 5920 | 0.23 5.8 |

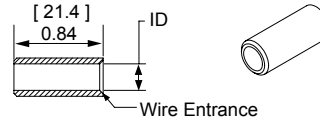

SBO® / SBE® / SBX® - Tooling Information

| Wire Size | | Loose Piece Part Number | Loose Piece Contact Crimp Tools | | | | | | | | |
|--|--------------------------|-------------------------|---------------------------------|---|---------|----------|----------|------------------|--------|------------------|---------|
| AWG | mm ² | Contacts | Pneumatic Bench Tool | + | Die | + | Locator | Number of Crimps | + | Hand Tools | |
| SBE® 320 / SBX® 350 | | | | | | | | | | | |
| 300 MCM | 152 | 6358 | N/A | | N/A | | N/A | N/A | | 1368 Series | |
| 4/0 AWG | 107.2 | 6356 | 1387G2 | | 1303G12 | | 1303G28 | Double | | | |
| 3/0 AWG | 85 | 6355 | | | | | | | | | |
| 2/0 AWG | 67.4 | 6354 | | | | | | | | | |
| 2 | N/A | 6394 | | | | 1303G2 | | | | | 1304G28 |
| N/A | 95 mm ² | 1341G3 | | | | 1303G17 | | | | | 1304G35 |
| N/A | 70 mm ² | 1341G2 | | | | 1303G12 | | | | | 1304G34 |
| N/A | 50 mm ² | 1341G1 | | | | 1303G8 | | | | | 1304G36 |
| SBE® 160 / SBX® 175 | | | | | | | | | | | |
| 1/0 AWG | 53.5 | 6384G1 | 1387G2 | | 1303G13 | | 1304G32 | Double | | 1368 series | |
| 2 | 25 mm ² | 6384G2 | 1387G2 | | 1303G13 | | 1304G32 | Double | | | |
| 1/0 & #2 | 53.5 to 5mm ² | 6384G1 & 6384G2 | 1387G1 | | 1388G3 | | 1389G3 | Single | | | |
| SBO® 60 / SBE® 80 | | | | | | | | | | | |
| 4 | 25 | 1339G4 | 1387G1 | | 1388G7 | | 1389G9 | Single | | N/A | |
| 6 | 16 | 1339G1 | | | 1388G6 | | | | 1309G4 | | |
| Powerpole® 15/45 Auxiliary Contacts ** | | | | | | | | | | | |
| 16 to 20 | 1.3 to .52 | 1332 | N/A | | N/A | | N/A | Single | | 1309G2 or 1309G8 | |
| 12 to 16 | 3.3 to 1.3 | 1331 | | | | | | | | | |
| PowerMod® 1x4 Auxiliary Contacts | | | | | | | | | | | |
| 12 to 24 | 2.5 to 0.25 | All Crimp Pins | TP0001* | | N/A | | TL0001 | Single | | TM0001* | |
| | | All Crimp Sockets | | | | TL0002 | PM1000G1 | | | | |
| PPMX Auxiliary Contacts | | | | | | | | | | | |
| 20 to 24 | 0.50 to 0.25 | 4803G3 | TP0001* | | N/A | | TL0005 | Single | | TM0001* or | |
| | | 4802G3 | | | | PM1000G1 | | | | | |
| Tools | | | | | | | | | | | |
| PM1002G1 - 1 x 4 Auxiliary Contact Insertion Tool - For use with PM contacts and 1x4 auxiliary housing (444G1 housings and 441G kits) | | | | | | | | | | | |
| PM1003G1 - 1 x 4 Auxiliary Contact Insertion Tool - For use with PM contacts and 1x4 auxiliary housing (444G1 housings and 441G kits) | | | | | | | | | | | |
| PM1003GX - 1x4 Auxiliary contacts Inspection Tool - For use with PM contacts and 1x4 auxiliary housing (444G1 housings and 441G kits) | | | | | | | | | | | |
| 969P1 - SBE® 160 / SBX® 175 Power Contact Extraction Tool | | | | | | | | | | | |
| 970P1 - SBE® 320 / SBX® 350 Power Contact Extraction Tool | | | | | | | | | | | |

SBO® / SBE® / SBX®
TOOLING

* TP0001 and TM0001 tools require locators to properly position contacts.

** See Powerpole® family tooling chart for other Powerpole® contacts

The auxiliary contacts used with wire sizes 16 to 24 AWG cannot be properly inserted without the insertion tool. Properly installed auxiliary contact of all wire gauges cannot be removed from the housing without the extraction tool.

SB[®] Smart Connector

Up to 230 Amps



Battery



Vehicle Device



Charger

The SB[®] Smart is designed for applications where storage batteries intelligently interact with the system. Two primary power positions (up to 230 amps each) are combined with sixteen auxiliary power / signal positions (up to 15 amps each) into a single interconnect solution. This allows one connection to be used to route high power lines, low power lines, and signal circuits.

Unique to the SB[®] Smart is its selective keyed housings that allow only mating between select connector halves. This prevents motors from mating with chargers, chargers from mating with chargers, or other undesirable connection scenarios.

- **Selective Keyed Housings**

Unique keying feature only allows intended connector halves to mate

- **Power and Auxiliary Contacts**

Provides power up to 230 amps plus signal & low power in a single connector

- **16 Last-Mate First-Break Auxiliary Power / Signal Poles**

Enables the power connector to also transmit signals for intelligent power switching, battery monitoring, CAN communication, loop circuitry, and other signal or power circuits up to 15 amps

- **Sequencing of Auxiliary Contacts**

Male auxiliary contacts available in 3 lengths

- **Wire and Busbar Connections**

Satisfies multiple interconnect needs with one connection solution

- **Low Resistance Connection**

Silver plated power contacts are strongly forced together by stainless steel springs

Gold plated auxiliary contacts ensure signal quality or reliable power

- **Hot Plug Capable Contacts**

Power contacts are hot plug capable up to 60A at 120VDC

Auxiliary contacts are hot plug capable up to 5A at 120VDC

SB[®] SMART

ORDERING INFORMATION

SB[®] Smart Housings (Auxiliary Module Sold Separately)

| Color | Housing Type / Marking | Mates With | Part Numbers |
|-------|-------------------------|-----------------|--------------|
| Black | Battery BAT-G1 | VEH-G2 & CHR-G4 | 115158G1 |
| Black | Vehicle / Device VEH-G2 | BAT-G1 | 115158G2 |
| Black | Charger CHR-G4 | BAT-G1 | 115158G4 |

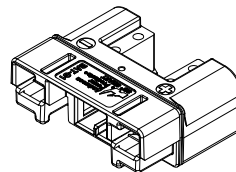

Top View

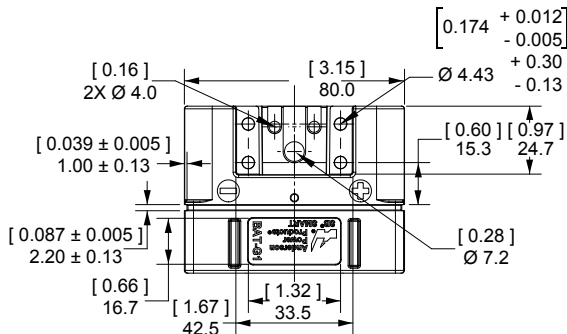

Side View

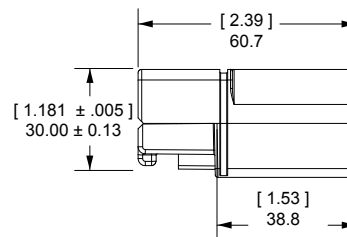

Mated Pairings Illustrations

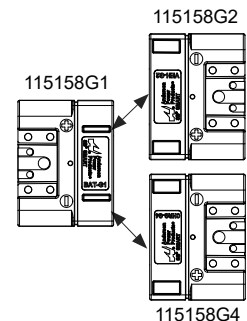

SB® Smart Silver Plated Wire Contacts

Silver plated contacts offer superior electrical performance and durability up to 10,000 mating cycles. New contacts for 1 to 1/0 AWG (35 to 50 mm²) offer extended capability in the same housings.

| AWG | mm ² | Mating Force | Loose Piece Part Numbers | | | - A - | | - B - | |
|------------------|-----------------|--------------|--------------------------|-----------|--------|--------|-------|--------|-------|
| | | | | | | inches | mm | inches | mm |
| Minimum Quantity | | | 600 | 500 | 50 | | | | |
| 1/0 | 53.5 | Low | 1323G2-BK | - | 1323G2 | 0.52 | 13.21 | 0.44 | 11.18 |
| 1 | 42.4 | Low | 1323G1-BK | - | 1323G1 | 0.47 | 11.94 | 0.39 | 9.91 |
| 2 | 33.6 | High | - | 1319-BK | 1319 | 0.44 | 11.18 | 0.34 | 8.64 |
| 4 | 21.1 | High | - | 1319G4-BK | 1319G4 | 0.44 | 11.18 | 0.29 | 7.37 |
| 6 | 13.3 | High | - | 1319G6-BK | 1319G6 | 0.44 | 11.18 | 0.22 | 5.59 |

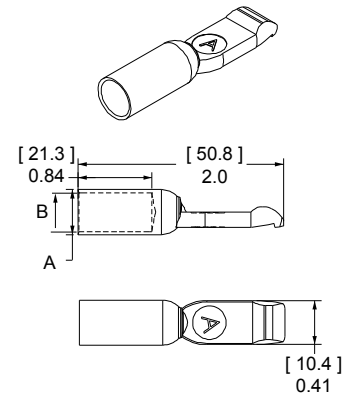

SB® Smart Silver Plated Busbar Contacts

Use 2 busbar contacts per housing to provide a quick disconnect input or output busbar connection. Busbar contacts are for mating with wire contacts only. Part number 120BBS includes lock nuts. Locknuts must be ordered separately for B01997P1.

| Type | Thread | Mating Force | Loose Piece Part Numbers | | | |
|------------------|----------|--------------|--------------------------|----------|--------|--------|
| Minimum Quantity | | | 1,000 | 300 | 20 | 10 |
| Busbar | 10 to 24 | High | - | B01997P1 | - | 120BBS |
| Lock Nut | 10 to 24 | - | H1216P8 | - | 110G54 | - |

See Busbar contact drawing on website for further detail.

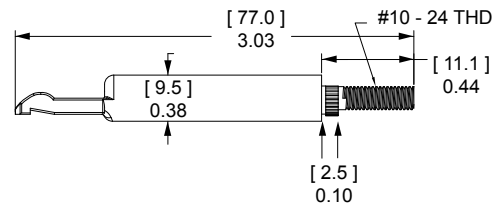

Reducing Bushings

Use with contact part number 1319-BK or 6811G6-BK to allow a smaller wire to be used with the connector. Electrical capability is derated with smaller wire.

| Contact Barrel Size | | Wire Size | | Part Numbers | | | Dimensions - ID - | |
|---------------------|-----------------|-----------|-----------------|--------------|---------|------|-------------------|------|
| AWG | mm ² | AWG | mm ² | | | | inches | mm |
| Minimum Quantity | | | | 2,000 | 1,000 | 100 | | |
| 2 | 33.6 | 4 | 21.2 | 5919-BK | - | 5919 | 0.28 | 7.11 |
| 2 | 33.6 | 6 | 16 | - | 5920-BK | 5920 | 0.23 | 5.84 |
| 2 | 33.6 | 10 to 8 | 5.3 to 8.4 | 5921-BK | - | 5921 | 0.18 | 4.57 |

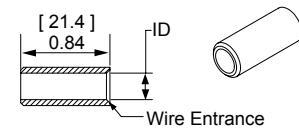

SB® Smart Auxiliary Module

| Color | Number of Positions | Part Number |
|------------------|---------------------|-------------|
| Minimum Quantity | | |
| Black | 8 Pins + 8 Sockets | 3-6018P1 |

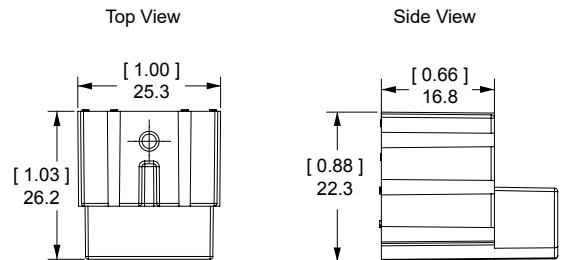
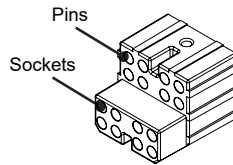
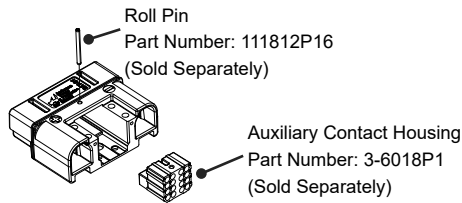

Retaining Pins

Retaining pins are used to hold the auxiliary module in the SB® Smart housings. Dimension "B" is +/- 0.01 in or 0.25 mm.

| Description | Part Number | Dimensions | | | |
|------------------|-------------|---------------|-------------|-------|-------|
| | | - A - | | - B - | |
| | | inches | | mm | |
| Minimum Quantity | | | | | |
| For SB® Smart | | | | | |
| Auxiliary Module | 111812P16 | 0.099 / 0.106 | 2.51 / 2.69 | 1.125 | 28.58 |

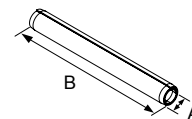

Pin Contacts for 1x4 Auxiliary Connector

Gold plated contacts are available in 3 lengths to allow sequencing of circuits.

| Description | AWG | mm ² | Part Numbers | |
|------------------------|----------|-----------------|--------------|-----------------|
| Minimum Quantity | | | 500 | 50 |
| Standard Length 7.7 mm | 12 | 2.5 | PM16P12S30 | PM16P12S30-50 |
| | 16 to 14 | 1.0 to 1.5 | PM16P1416S30 | PM16P1416S30-50 |
| | 20 to 16 | 0.75 to 1.0 | PM16P1620S30 | PM16P1620S30-50 |
| | 24 to 20 | 0.50 to 0.75 | PM16P2024S30 | PM16P2024S30-50 |
| Pre-Mate 9.3 mm | 12 | 2.5 | PM16P12A30 | PM16P12A30-50 |
| | 16 to 14 | 1.0 to 1.5 | PM16P1416A30 | PM16P1416A30-50 |
| | 20 to 16 | 0.75 to 1.0 | PM16P1620A30 | PM16P1620A30-50 |
| | 24 to 20 | 0.50 to 0.75 | PM16P2024A30 | PM16P2024A30-50 |
| Post-Mate 6.4 mm | 12 | 2.5 | PM16P12C30 | PM16P12C30-50 |
| | 16 to 14 | 1.0 to 1.5 | PM16P1416C30 | PM16P1416C30-50 |
| | 20 to 16 | 0.75 to 1.0 | PM16P1620C30 | PM16P1620C30-50 |
| | 24 to 20 | 0.50 to 0.75 | PM16P2024C30 | PM16P2024C30-50 |

| Auxiliary Pin | - L - | | - L1 - | |
|------------------------|-------|------|--------|-----|
| Contact Lengths | in. | mm | in. | mm |
| Standard Length 7.7 mm | 0.77 | 19.6 | 0.30 | 7.7 |
| Pre-Mate 9.3 mm | 0.83 | 21.2 | 0.37 | 9.3 |
| Post-Mate 6.6 mm | 0.72 | 18.3 | 0.25 | 6.4 |

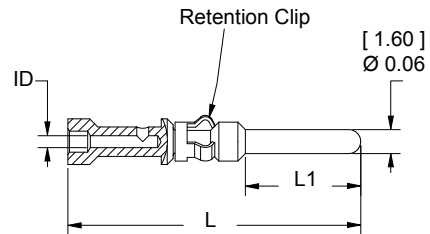

Socket Contacts for 1x4 Auxiliary Connector

Selectively gold plated contacts offer low resistance and durability up to 10,000 mating cycles.

| Description | AWG | mm ² | Part Numbers | |
|------------------|----------|-----------------|--------------|-----------------|
| Minimum Quantity | | | 500 | 50 |
| Socket Contact | 12 | 2.5 | PM16S12S32 | PM16S12S32-50 |
| | 16 to 14 | 1.0 to 1.5 | PM16S1416S32 | PM16S1416S32-50 |
| | 20 to 16 | 0.75 to 1.0 | PM16S1620S32 | PM16S1620S32-50 |
| | 24 to 20 | 0.50 to 0.75 | PM16S2024S32 | PM16S2024S32-50 |

Auxiliary Socket Contacts Crimp Barrel ID

| Wire Gauge | in. | mm. |
|------------|------|-----|
| 24 / 20 | 0.04 | 1.1 |
| 20 / 16 | 0.07 | 1.7 |
| 16 / 14 | 0.08 | 2.1 |
| 12 | 0.10 | 2.6 |

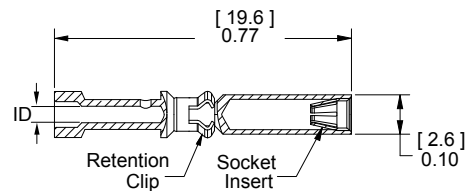

SB® SMART TEMPERATURE CHARTS - Temperature rise charts are based on a 25°C ambient temperature.

Current - Temperature Derating per IEC 60512-5-2 Test 5B

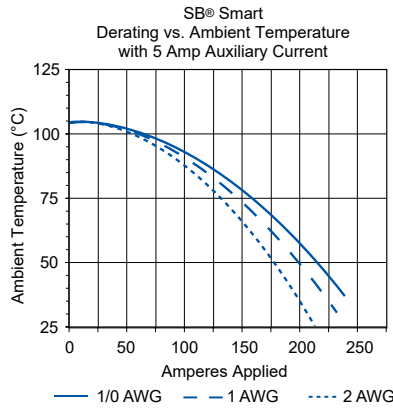
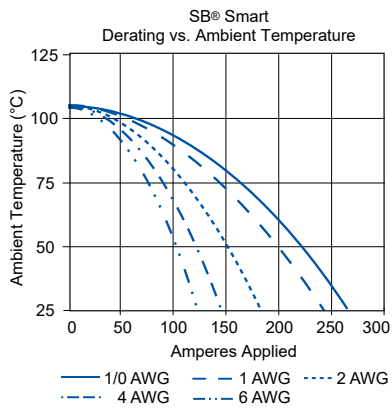
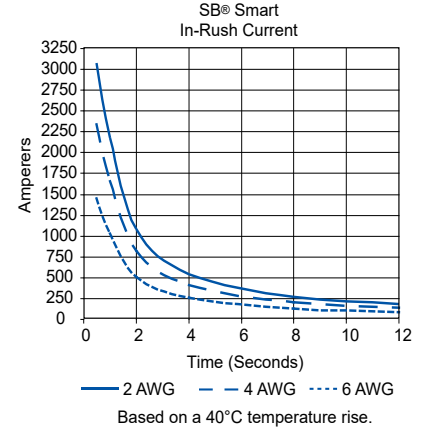
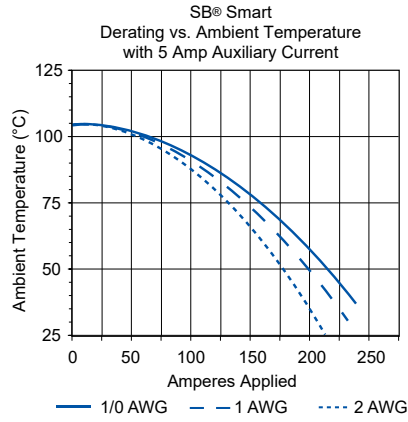
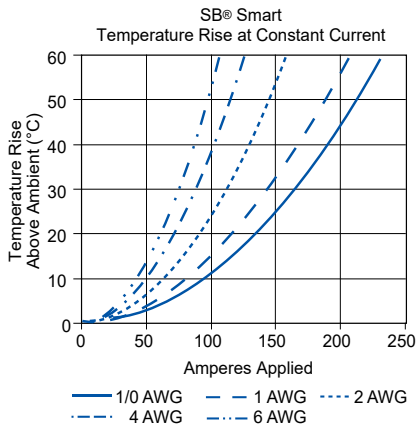

SB® SMART

SPECIFICATIONS

| ELECTRICAL | | |
|---|--------------|-------------|
| Current Rating (Amperes)¹ | | |
| Primary Contacts | 230 | |
| Auxiliary Contacts | 15 | |
| Operating Temperature² | | |
| | °C | °F |
| PC Housing | -20° to 105° | -4° to 221° |
| Voltage Rating (AC/DC) | | |
| | 600 | |
| Dielectric Withstanding Voltage (AC) | | |
| | 2,200 | |

| MATERIALS | |
|------------------------------|---------------------------------|
| Standard Housing | PC |
| Flammability Rating | UL94 V-0 |
| Wire Power Contact | Copper Alloy, Silver Plate |
| PCB Power Contact | Copper Alloy, Tin Plate |
| Auxiliary Pin | Copper Alloy, Au over Ni |
| Auxiliary Socket | BeCu, Au over Ni |
| Auxiliary Socket Body | Copper Alloy, Sn Bright over Ni |

| MECHANICAL | | Primary Power | Auxiliary Power |
|--|--------------------|---------------|-----------------|
| Contact Wire Range | (AWG) | 10 to 1/0 | 24 to 12 |
| | (mm ²) | 5.3 to 53.5 | 0.25 to 3.3 |
| MAX Wire Insulation Diameter | (in) | 0.65 | 0.12 |
| | (mm) | 16.25 | 3.2 |
| AVG Contact Resistance (milli-ohms)³ | | 0.136 | 3.00 |
| AVG Contact Retention Force | (lbf) | 60 | 18 |
| | (N) | 267 | 80 |
| Mating Cycles (no load) | | 10,000 | 10,000 |
| Mating Cycles (hot plug @ 120V) | | 250 @ 50A | 250 @ 5A |
| Connector AVG Connect / Disconnect | (lbf) | 82 | |
| | (N) | 365 | |

1 - Based on: 105°C rated or better cable of the largest size. Properly calibrated APP® recommended tooling, and a 25°C ambient temperature.

2 - Limited by the thermal properties of the connector plastic housing.

3 - Use APP® recommended tooling only. Alternate tools may adversely affect the performance of our connectors.

TOOLING INFORMATION

| Wire Size | | Loose Piece Part Number | | Loose Piece Contact Crimp Tools | | | | | | | |
|------------------------|-----------------|-------------------------|----------------|---------------------------------|----|----------------------|---|-----|---|---------|------------------|
| AWG | mm ² | Tin Plating | Silver Plating | Hand Tool or | OR | Pneumatic Bench Tool | + | Die | + | Locator | Number of Crimps |
| SMART Connector | | | | | | | | | | | |
| 1/0 | 53.5 | N/A | 1323G2 | 1368 | | 1387G1 | | | | 1389G4 | Single |
| 1 | 42.4 | | 1323G1 | | | | | | | | |
| 2 | 33.6 | | 1319 | | | | | | | | |
| 4 | 21.2 | | 1319G4 | | | | | | | | |
| 6 | 13.3 | | 1319G6 | | | | | | | | |

NOTE: See website for the most current information.

| Wire Size | | Loose Piece Part Number | | Loose Piece Contact Crimp Tools | | | | | | |
|--|-----------------|-------------------------------|--------------------------------------|---------------------------------|----------------------------------|----|-----------------|------------------|---|------------------------------|
| AWG | mm ² | Auxiliary Contact Part Number | APP® Hand Tool with Integral Locator | OR | Mil Std. Hand Tool * M22520/1-01 | OR | Pneumatic Tool* | Number of Crimps | + | Locator for: TM0001 & TP0001 |
| SMART Connector | | | | | | | | | | |
| 12 to 25 | 2.5 to 0.25 | All Crimp Pins | PM1000G1 | | TM0001 | | TP0001 | Single | | TL0001 |
| | | All Crimp Sockets | | | | | | | | TL0002 |
| PM1002G1 - 1 x 4 Auxiliary Contact Insertion Tool - For use with PM contacts and 1x4 auxiliary housing (444G1 housings and 441G kits) | | | | | | | | | | |
| PM1003G1 - 1 x 4 Auxiliary Contact Insertion Tool - For use with PM contacts and 1x4 auxiliary housing (444G1 housings and 441G kits) | | | | | | | | | | |
| PM1003GX - 1x4 Auxiliary contacts Inspection Tool - For use with PM contacts and 1x4 auxiliary housing (444G1 housings and 441G kits) | | | | | | | | | | |
| 969P1 - SBE® 160 / SBX® 175 Power Contact Extraction Tool | | | | | | | | | | |
| 970P1 - SBE® 320 / SBX® 350 Power Contact Extraction Tool | | | | | | | | | | |

* TP0001 and TM0001 tools require locators TL0001 for Pins and TL0002 for Sockets.

NOTE: See website for the most current information.

| Contact Part Number | Description | Hand Tool | Automated Tooling | |
|---------------------|--|-----------|--------------------------------|------------|
| | | | Press | Applicator |
| 2003G1 | Receptacle Contact, Reeled | - | 115V = TE0101 230V = TE0102 | TD0104 |
| 2003G1-LPBK | Receptacle Contact, Loose Piece | 1309G9 | - | - |
| 2003G2-LPBK | Receptacle Contact, Loose Piece, 10AWG | 1309G10 | - | - |

Part Number Page Reference

| PART NUMBER | PAGE NUMBER |
|-------------|--------------------------------|
| 902 | 89 |
| 906 | 96 |
| 907 | 96, 100, 101 |
| 908 | 96, 101 |
| 910 | 96, 101 |
| 912 | 96 |
| 913 | 96 |
| 914 | 96 |
| 916 | 96, 101 |
| 917 | 96, 101 |
| 919 | 100 |
| 931 | 96 |
| 932 | 96 |
| 940 | 88 |
| 941 | 88 |
| 942 | 88 |
| 943 | 88 |
| 945 | 93 |
| 949 | 88 |
| 990 | 76, 83 |
| 992 | 78 |
| 1307 | 42, 56, 79, 101 |
| 1319 | 48, 56, 84, 101, 125, 128 |
| 1321 | 48 |
| 1327 | 30, 105, 111, 118 |
| 1331 | 31, 56, 64, 105, 111, 118, 123 |
| 1332 | 31, 56, 64, 118, 123 |
| 1347 | 52, 56, 89, 101 |
| 1348 | 52, 56, 89, 101 |
| 1368 | 4, 5, 56, 101, 123, 128 |
| 1381 | 52 |
| 1382 | 52, 56, 89, 91, 95, 101 |
| 1383 | 52, 56, 89, 101 |
| 1384 | 52, 56, 89, 101 |
| 5648 | 95, 114, 122 |
| 5663 | 95, 114, 122 |
| 5687 | 95, 114, 122 |
| 5690 | 95, 114, 122 |

| PART NUMBER | PAGE NUMBER |
|-------------|---------------------|
| 5693 | 95, 114, 122 |
| 5900 | 42, 56, 79, 81, 101 |
| 5905 | 76, 83 |
| 5910 | 77, 83, 107 |
| 5912 | 77, 83, 107 |
| 5913 | 77, 83, 107 |
| 5915 | 42, 56, 79, 101 |
| 5916 | 41 |
| 5918 | 100, 122 |
| 5919 | 87, 125 |
| 5920 | 87, 114, 122, 125 |
| 5921 | 87, 125 |
| 5952 | 42, 56, 79, 101 |
| 5953 | 42, 56, 79, 101 |
| 6339 | 115 |
| 6344 | 105, 111 |
| 6350 | 115 |
| 6351 | 115 |
| 6352 | 115 |
| 6353 | 115 |
| 6354 | 115, 122, 123 |
| 6355 | 115, 123 |
| 6356 | 115, 123 |
| 6358 | 115, 123 |
| 6361 | 115 |
| 6362 | 115 |
| 6394 | 115, 122, 123 |
| 104G17 | 76, 82 |
| 105G1 | 114 |
| 105G13 | 105 |
| 105G3 | 93 |
| 105G8 | 93, 111 |
| 106G6 | 100, 121 |
| 106G7 | 99, 118 |
| 110G10 | 34 |
| 110G12 | 40 |
| 110G16 | 39 |
| 110G17 | 39 |
| 110G18 | 47, 55 |
| 110G19 | 47, 51 |
| 110G20 | 51, 55 |

| PART NUMBER | PAGE NUMBER |
|-------------|-----------------|
| 110G21 | 40 |
| 110G34 | 89 |
| 110G50 | 35 |
| 110G51 | 35 |
| 110G54 | 42, 79, 85, 125 |
| 110G55 | 53, 89 |
| 110G56 | 53, 89 |
| 110G59-BK | 120 |
| 110G68 | 40 |
| 110G73 | 97 |
| 110G9 | 34, 107, 113 |
| 110G9-BK | 34, 107, 113 |
| 111038G2 | 56, 64 |
| 111038G3 | 77 |
| 111812P16 | 125 |
| 111812P5 | 39 |
| 111812P6 | 47, 55 |
| 111812P7 | 47, 51 |
| 111812P8 | 51, 55 |
| 111961P1 | 121 |
| 111961P2 | 114 |
| 113715P4 | 105 |
| 113716P3 | 105 |
| 113890P1 | 76, 82 |
| 113890P2 | 93 |
| 113890P3 | 99 |
| 113899P1 | 76, 82, 87 |
| 113899P2 | 76 |
| 113952P1 | 105 |
| 113953P1 | 105 |
| 114411P1 | 46 |
| 114411P2 | 46 |
| 114411P3 | 46 |
| 114555P1 | 40 |
| 114555P10 | 40 |
| 114555P2 | 40 |
| 114555P3 | 40 |
| 114555P6 | 40 |
| 114555P7 | 40 |
| 114555P9 | 40 |
| 115107G1 | 88 |

| PART NUMBER | PAGE NUMBER |
|-------------|---------------------|
| 115158G1 | 125 |
| 115158G2 | 125 |
| 115158G4 | 125 |
| 115G1 | 34 |
| 115G1-BK | 34 |
| 115G2 | 34 |
| 115G23 | 34 |
| 115G23-BK | 34 |
| 115G2-BK | 34 |
| 115G3 | 34 |
| 115G3-BK | 34 |
| 115G4 | 34 |
| 115G4-BK | 34 |
| 115G7 | 34 |
| 115G7-BK | 34 |
| 115G8 | 34 |
| 115G8-BK | 34 |
| 120BBS | 85, 125 |
| 1303G12 | 56, 101, 123 |
| 1303G13 | 56, 101, 123 |
| 1303G17 | 123 |
| 1303G2 | 123 |
| 1303G28 | 123 |
| 1303G3 | 101 |
| 1303G8 | 123 |
| 1304G28 | 123 |
| 1304G31 | 101 |
| 1304G32 | 56, 101, 123 |
| 1304G34 | 123 |
| 1304G35 | 123 |
| 1304G36 | 123 |
| 1307-BK | 42, 79 |
| 1309 | 4, 6 |
| 1309G10 | 5, 128 |
| 1309G2 | 6, 56, 64, 123 |
| 1309G3 | 6, 56, 64 |
| 1309G4 | 6, 56, 77, 101, 123 |
| 1309G6 | 6, 56 |
| 1309G8 | 6, 56, 64, 123 |
| 1309G9 | 5, 128 |
| 1310G2 | 6 |
| 1310G3 | 6 |

| PART NUMBER | PAGE NUMBER |
|-------------|---------------------------|
| 1310G4 | 6 |
| 1310G6 | 6 |
| 1310G8 | 6 |
| 1317G1 | 31 |
| 1317G11 | 31 |
| 1317G11-BK | 31 |
| 1317G12 | 31 |
| 1317G12-BK | 31 |
| 1317G13 | 31 |
| 1317G13-BK | 31 |
| 1317G1-BK | 31 |
| 1317G2 | 31 |
| 1317G2-BK | 31 |
| 1317G3 | 31 |
| 1317G3-BK | 31 |
| 1317G4 | 31 |
| 1317G4-BK | 31 |
| 1319-BK | 48, 84, 87, 125 |
| 1319G4 | 48, 56, 84, 101, 125, 128 |
| 1319G4-BK | 48, 84, 125 |
| 1319G6 | 48, 56, 84, 101, 125, 128 |
| 1319G6-BK | 48, 84, 125 |
| 1321 | 48 |
| 1321-BK | 48 |
| 1321G1 | 48 |
| 1321G1-BK | 48 |
| 1321G2 | 48 |
| 1321G2-BK | 48 |
| 1321G3 | 48 |
| 1321G3-BK | 48 |
| 1321G4 | 48 |
| 1321G4-BK | 48 |
| 1321G5 | 48 |
| 1321G5-BK | 48 |
| 1321G6 | 48 |
| 1321G6-BK | 48 |
| 1321G7 | 48 |
| 1321G7-BK | 48 |
| 1321G8 | 48 |
| 1321G8-BK | 48 |

| PART NUMBER | PAGE NUMBER |
|--------------|---------------------------|
| 1323G1 | 48, 56, 84, 101, 125, 128 |
| 1323G1-BK | 48, 84, 125 |
| 1323G2 | 48, 56, 125, 128 |
| 1323G2-BK | 48, 125 |
| 1327-BK | 30 |
| 1327FP | 30 |
| 1327FP-BK | 30 |
| 1327G16 | 30 |
| 1327G16-BK | 30 |
| 1327G16FP | 30 |
| 1327G16FP-BK | 30 |
| 1327G17 | 30 |
| 1327G17-BK | 30 |
| 1327G18 | 30 |
| 1327G18-BK | 30 |
| 1327G21 | 30 |
| 1327G21-BK | 30 |
| 1327G22 | 30 |
| 1327G22-BK | 30 |
| 1327G23 | 30 |
| 1327G23-BK | 30 |
| 1327G5 | 30 |
| 1327G5-BK | 30 |
| 1327G5FP | 30 |
| 1327G5FP-BK | 30 |
| 1327G6 | 30, 105, 111, 118 |
| 1327G6-BK | 30 |
| 1327G6FP | 30 |
| 1327G6FP-BK | 30 |
| 1327G7 | 30 |
| 1327G7-BK | 30 |
| 1327G7FP | 30 |
| 1327G7FP-BK | 30 |
| 1327G8 | 30 |
| 1327G8-BK | 30 |
| 1327G8FP | 30 |
| 1327G8FP-BK | 30 |
| 1328G1 | 52, 56, 89, 101 |
| 1328G1-BK | 52, 89 |
| 1328G2 | 52, 56 |
| 1328G2-BK | 52 |

| PART NUMBER | PAGE NUMBER |
|-------------|---------------|
| 1331-BK | 31, 64 |
| 1332-BK | 31, 64 |
| 1335G1 | 32 |
| 1336G1 | 32 |
| 1337G1 | 32 |
| 1339G1 | 102, 107, 123 |
| 1339G1-BK | 102 |
| 1339G2 | 69, 77 |
| 1339G2-BK | 69 |
| 1339G3 | 69, 77 |
| 1339G3-BK | 69 |
| 1339G4 | 102, 123 |
| 1339G4-BK | 102 |
| 1339G5 | 69, 77 |
| 1339G5-BK | 69 |
| 1340G1 | 69, 77 |
| 1340G1-BK | 69 |
| 1340G2 | 69, 77 |
| 1340G2-BK | 69 |
| 1340G3 | 69, 77 |
| 1340G3-BK | 69 |
| 1341G1 | 115, 123 |
| 1341G1-BK | 115 |
| 1341G2 | 115, 123 |
| 1341G2-BK | 115 |
| 1341G3 | 115, 123 |
| 1341G3-BK | 115 |
| 1347-BK | 52, 89 |
| 1348-BK | 52, 89 |
| 134G1 | 76, 82 |
| 134G2 | 93 |
| 134G3 | 99 |
| 134G4 | 87 |
| 1368-NL | 4, 5 |
| 1377G1 | 31 |
| 1377G11 | 31 |
| 1377G11-BK | 31 |
| 1377G12 | 31 |
| 1377G12-BK | 31 |
| 1377G13 | 31 |
| 1377G13-BK | 31 |
| 1377G1-BK | 31 |

| PART NUMBER | PAGE NUMBER |
|-------------|------------------------|
| 1377G2 | 31 |
| 1377G2-BK | 31 |
| 1377G3 | 31 |
| 1377G3-BK | 31 |
| 1377G4 | 31 |
| 1377G4-BK | 31 |
| 1381-BK | 52 |
| 1381G1 | 52 |
| 1381G1-BK | 52 |
| 1381G2 | 52 |
| 1381G2-BK | 52 |
| 1381G3 | 52 |
| 1381G3-BK | 52 |
| 1381G4 | 52 |
| 1381G4-BK | 52 |
| 1382-BK | 52, 89, 95 |
| 1383-BK | 52, 89 |
| 1384-BK | 52, 89 |
| 1387G1 | 4, 5, 56, 77, 101, 128 |
| 1387G2 | 4, 5, 56, 101 |
| 1388G3 | 56, 101, 123, 128 |
| 1388G4 | 56, 101, 128 |
| 1388G6 | 56, 77, 101, 123 |
| 1388G7 | 56, 77, 101, 123 |
| 1389G20 | 77 |
| 1389G21 | 56 |
| 1389G3 | 56, 101, 123 |
| 1389G4 | 56, 101, 128 |
| 1389G6 | 56, 101 |
| 1389G7 | 101 |
| 1389G9 | 77, 123 |
| 1391G1 | 5 |
| 1399G1 | 39 |
| 1399G10 | 39 |
| 1399G10-BK | 39 |
| 1399G13 | 39 |
| 1399G13-BK | 39 |
| 1399G14 | 39 |
| 1399G14-BK | 39 |
| 1399G17 | 39 |
| 1399G17-BK | 39 |
| 1399G1-BK | 39 |

| PART NUMBER | PAGE NUMBER |
|-------------|-------------|
| 1399G2 | 39 |
| 1399G20 | 46 |
| 1399G20-BK | 46 |
| 1399G21 | 46 |
| 1399G21-BK | 46 |
| 1399G23 | 46 |
| 1399G23-BK | 46 |
| 1399G2-BK | 39 |
| 1399G6 | 39 |
| 1399G6-BK | 39 |
| 1399G7 | 46 |
| 1399G7-BK | 46 |
| 1399G8 | 39 |
| 1399G8-BK | 39 |
| 1399G9 | 39 |
| 1399G9-BK | 39 |
| 1441G1 | 40 |
| 1442G1 | 40 |
| 1460G1 | 33 |
| 1460G1-BK | 33 |
| 1460G2 | 33 |
| 1460G23 | 34 |
| 1460G23-BK | 34 |
| 1460G2-BK | 33 |
| 1460G3 | 33 |
| 1460G3-BK | 33 |
| 1460G4 | 33 |
| 1460G4-BK | 33 |
| 1461G1 | 33 |
| 1461G1-BK | 33 |
| 1461G2 | 33 |
| 1461G2-BK | 33 |
| 1461G3 | 33 |
| 1461G3-BK | 33 |
| 1462G1 | 39 |
| 1462G2 | 39 |
| 1462G3 | 39 |
| 1463G1 | 47 |
| 1463G2 | 47 |
| 1464G1 | 51 |
| 1464G2 | 51 |
| 1465G1 | 55 |

PART NUMBER PAGE REFERENCE

| PART NUMBER | PAGE NUMBER |
|-------------|----------------|
| 1465G2 | 55 |
| 1466G1 | 76 |
| 1467G1 | 86 |
| 1470G1 | 34 |
| 1470G1-BK | 34 |
| 1470G2 | 34 |
| 1470G2-BK | 34 |
| 1470G3 | 34 |
| 1470G3-BK | 34 |
| 1470G4 | 34 |
| 1470G4-BK | 34 |
| 180BBS | 53, 89 |
| 180BBS-BK | 53, 89 |
| 1827G1 | 30 |
| 1827G1-BK | 30 |
| 1830G1 | 31, 57 |
| 1830G1-LPBK | 31, 35, 56 |
| 1830G2 | 31, 57 |
| 1830G2-LPBK | 31, 56 |
| 1836G1 | 32 |
| 1875G1 | 42, 56 |
| 1875G1-BK | 42 |
| 1875G2 | 42, 56 |
| 1875G2-BK | 42 |
| 1875G3 | 42, 56 |
| 1875G3-BK | 42 |
| 20-01 | 35 |
| 2003G1 | 5, 128 |
| 2003G1-LPBK | 5, 128 |
| 2003G2-LPBK | 5, 128 |
| 200G1L | 31, 57 |
| 200G1L-LPBK | 31, 56 |
| 200G3L | 31, 57 |
| 200G3L-LPBK | 31, 56 |
| 201G1H | 31, 57 |
| 201G1H-LPBK | 31, 56 |
| 2-5048 | 89 |
| 2-5049 | 89 |
| 26-01 | 35 |
| 261G1 | 31, 57, 64 |
| 261G1-LPBK | 31, 56, 64 |
| 261G2 | 31, 37, 57, 64 |
| 261G2-LPBK | 31, 35, 56, 64 |

| PART NUMBER | PAGE NUMBER |
|-------------|-------------|
| 261G3 | 31, 57, 64 |
| 261G3-LPBK | 31, 56, 64 |
| 262G1 | 31, 57, 64 |
| 262G1-LPBK | 31, 57, 64 |
| 262G2 | 31, 57, 64 |
| 262G2-LPBK | 31, 56, 64 |
| 269G1 | 31, 57 |
| 269G1-LPBK | 31, 56 |
| 269G2 | 31, 57 |
| 269G2-LPBK | 31, 56 |
| 269G3 | 31, 57 |
| 269G3-LPBK | 31, 56 |
| 27-01 | 35 |
| 2-7249G1 | 115 |
| 2-7249G2 | 115 |
| 2-7249G3 | 115 |
| 2-7249G4 | 115 |
| 2-7249G5 | 115 |
| 2-7249G6 | 115 |
| 2-7249G7 | 115 |
| 2-7250G8 | 96 |
| 2-7251G1 | 108 |
| 2-7251G2 | 108 |
| 2-7251G3 | 108 |
| 2-7251G4 | 108 |
| 2-7251G5 | 108 |
| 2-7251G7 | 108 |
| 2-7252G11 | 88 |
| 2-8170G1 | 108 |
| 2-8170G14 | 108 |
| 2-8170G2 | 108 |
| 2-8170G3 | 108 |
| 2-8170G4 | 108 |
| 2-8170G5 | 108 |
| 2-8170G7 | 108 |
| 2-8171G1 | 115 |
| 2-8171G2 | 115 |
| 2-8171G3 | 115 |
| 2-8171G4 | 115 |
| 2-8171G5 | 115 |
| 2-8171G6 | 115 |
| 2-8171G7 | 115 |
| 2-8171G8 | 115 |

| PART NUMBER | PAGE NUMBER |
|-------------|-------------------------|
| 2-8171G9 | 115 |
| 2-8675P1 | 120 |
| 2-8675P2 | 113 |
| 2-8831P1 | 40 |
| 2-8831P1-BK | 40 |
| 2-8831P2 | 40 |
| 2-8831P2-BK | 40 |
| 3-5074P1 | 93, 99, 111, 118 |
| 3-5074P3 | 93, 99, 111, 118 |
| 3-5074P5 | 93, 99, 111, 118 |
| 350BBS | 97 |
| 3-5798P1 | 107, 113, 119 |
| 3-5911P1 | 32 |
| 3-5912P1 | 32 |
| 3-5913P1 | 32 |
| 3-5952P1 | 32 |
| 3-5956P1 | 105, 111, 118 |
| 3-6018P1 | 125 |
| 3-6034P1 | 87 |
| 3-6034P1-BK | 87 |
| 3-6035P1 | 87 |
| 3-6035P1-BK | 87 |
| 3-6036P1 | 94 |
| 3-6036P1-BK | 94 |
| 3-6037P1 | 94 |
| 3-6037P1-BK | 94 |
| 3-6054P1 | 83 |
| 3-6054P1-BK | 83 |
| 3-6054P2 | 83 |
| 3-6054P2-BK | 83 |
| 3-6055P1 | 83 |
| 3-6055P1-BK | 83 |
| 3-6055P2 | 83 |
| 3-6055P2-BK | 83 |
| 440G1 | 118 |
| 440G2 | 118 |
| 440G3 | 118 |
| 441G | 123, 128 |
| 441G1 | 105, 111 |
| 441G2 | 105, 111 |
| 441G3 | 105, 111 |
| 444G1 | 105, 111, 118, 123, 128 |

| PART NUMBER | PAGE NUMBER |
|-------------|------------------------------|
| 4802G3 | 106, 107, 112, 113, 120, 123 |
| 4802G3-BK | 107, 113, 120 |
| 4803G3 | 106, 107, 112, 113, 120, 123 |
| 4803G3-BK | 107, 113, 120 |
| 4827G6 | 106, 112, 120 |
| 4827G6-BK | 106, 112, 120 |
| 4850G6 | 106, 112, 120 |
| 5648-BK | 55, 95, 114, 122 |
| 5663-BK | 55, 95, 114, 122 |
| 5687-BK | 55, 95, 114, 122 |
| 5690-BK | 55, 95, 114, 122 |
| 5693-BK | 55, 95, 114, 122 |
| 5900-BK | 42, 79 |
| 5905-BK | 76, 83 |
| 5910-BK | 47, 77, 83, 107 |
| 5912-BK | 47, 77, 83, 107 |
| 5913-BK | 47, 77, 83, 107 |
| 5915-BK | 42, 79 |
| 5916-BK | 41 |
| 5916G14 | 41 |
| 5916G14-BK | 41 |
| 5916G15 | 41 |
| 5916G15-BK | 41 |
| 5916G16 | 41 |
| 5916G16-BK | 41 |
| 5916G4 | 41 |
| 5916G4-BK | 41 |
| 5916G5 | 41 |
| 5916G5-BK | 41 |
| 5916G6 | 41 |
| 5916G6-BK | 41 |
| 5916G7 | 41 |
| 5916G7-BK | 41 |
| 5918-BK | 100, 122 |
| 5919-BK | 51, 87, 125 |
| 5920-BK | 51, 87, 114, 122, 125 |
| 5921-BK | 51, 87, 125 |
| 5927G6 | 42 |
| 5927G6-BK | 42 |
| 5952-BK | 42, 79 |
| 5953-BK | 42, 79 |
| 6305G1 | 118 |

| PART NUMBER | PAGE NUMBER |
|----------------|--------------------|
| 6310G1 | 118 |
| 6354-BK | 115 |
| 6355-BK | 115 |
| 6356-BK | 115 |
| 6358-BK | 115 |
| 6380G1 | 108 |
| 6381G1 | 108 |
| 6382G1 | 108 |
| 6383G1 | 108 |
| 6384G1 | 108, 110, 114, 123 |
| 6384G1-BK | 108, 114 |
| 6384G2 | 108, 114, 123 |
| 6384G2-BK | 108, 114 |
| 6385G1 | 108 |
| 6390G1 | 108 |
| 6394-BK | 115 |
| 6396G1 | 107, 113, 119 |
| 6810G1 | 84 |
| 6810G1-BK | 84 |
| 6810G2 | 84 |
| 6810G2-BK | 84 |
| 6810G3 | 84 |
| 6810G3-BK | 84 |
| 6811G6-BK | 125 |
| 6811G7 | 84 |
| 75BBS | 42, 79 |
| 75LOKBLK | 41 |
| 75LOKBLK-BK | 41 |
| 75LOKBLU | 41 |
| 75LOKBLU-BK | 41 |
| 75LOKGRA | 41 |
| 75LOKGRA-BK | 41 |
| 75LOKGRN | 41 |
| 75LOKGRN-BK | 41 |
| 75LOKRED | 41 |
| 75LOKRED-BK | 41 |
| 75LOKSMTBLU | 46 |
| 75LOKSMTBLU-BK | 46 |
| 75LOKWHT | 41 |
| 75LOKWHT-BK | 41 |
| 75LOKWNGBLU | 46 |
| 75LOKWNGBLU-BK | 46 |
| 75LOKWNGBLU-R | 46 |

| PART NUMBER | PAGE NUMBER |
|------------------|-------------|
| 75LOKWNGBLU-R-BK | 46 |
| 906-BK | 96 |
| 907-BK | 96, 100 |
| 908-BK | 96 |
| 910-BK | 96 |
| 911G2 | 118 |
| 912-BK | 96 |
| 913-BK | 96 |
| 914-BK | 96 |
| 916-BK | 96 |
| 917-BK | 96 |
| 919G1 | 100 |
| 922G1 | 100 |
| 923G1 | 94 |
| 924G1 | 94 |
| 931-BK | 96 |
| 932-BK | 96 |
| 940-BK | 88 |
| 941-BK | 88 |
| 942-BK | 88 |
| 943-BK | 88 |
| 945G2 | 111 |
| 945G3 | 93 |
| 945G3-BK | 93 |
| 946G1 | 93 |
| 946G1-BK | 93 |
| 949-BK | 88 |
| 969P1 | 123, 128 |
| 970P1 | 123, 128 |
| 981G1 | 86 |
| 981G2 | 86 |
| 990-BK | 76, 83 |
| 990G1 | 76, 83 |
| 990G1-BK | 76, 83 |
| 990G2 | 76, 83 |
| 990G2-BK | 76, 83 |
| 992-BK | 78 |
| 992G1 | 78 |
| 992G1-BK | 78 |
| 992G2 | 78 |
| 992G2-BK | 78 |
| 992G4 | 78 |
| 992G4-BK | 78 |

PART NUMBER PAGE REFERENCE

| PART NUMBER | PAGE NUMBER |
|------------------|-------------|
| 992G5 | 78 |
| 992G5-BK | 78 |
| 992G6 | 78 |
| 992G6-BK | 78 |
| 992G7 | 78 |
| 992G7-BK | 78 |
| 993G1 | 121 |
| 993G2 | 114 |
| 994G1 | 121 |
| 994G2 | 114 |
| 995G1 | 93, 111 |
| 995G1-APP | 111 |
| 995G2 | 99, 118 |
| 995G2-APP | 118 |
| 995G3 | 93, 111 |
| 995G3-APP | 111 |
| 995G4 | 99, 118 |
| 995G4-APP | 118 |
| 996G1 | 99 |
| 997G1 | 76, 82, 87 |
| ASMFP30-1X2-KR | 32 |
| ASMFP30-1X2-RK | 32 |
| ASMFP30-1X3-KER | 32 |
| ASMFP30-1X3-KEW | 32 |
| ASMFP30-2X1-KR | 32 |
| ASMFP30-2X1-RK | 32 |
| ASMFP30-2X2-KRWE | 32 |
| ASMFP30-2X2-WEKR | 32 |
| ASMFR45-1X2-KR | 32 |
| ASMFR45-1X2-RK | 32 |
| ASMFR45-1X3-KER | 32 |
| ASMFR45-1X3-KEW | 32 |
| ASMFR45-2X1-KR | 32 |
| ASMFR45-2X1-RK | 32 |
| ASMFR45-2X2-WEKR | 32 |
| ASMFV45-1X2-KR | 32 |
| ASMFV45-1X2-RK | 32 |
| ASMFV45-2X1-KR | 32 |
| ASMFV45-2X1-RK | 32 |
| ASMPP30-1X2-KR | 32 |
| ASMPP30-1X2-RK | 32 |
| ASMPR45-1X2-KR | 32 |
| ASMPR45-1X2-RK | 32 |

| PART NUMBER | PAGE NUMBER |
|----------------|-----------------|
| ASMPV45-1X2-KR | 32 |
| ASMPV45-1X2-RK | 32 |
| B00229P1 | 100 |
| B00511G2 | 114 |
| B00511G4 | 121 |
| B01915P1 | 42, 79 |
| B01997P1 | 85, 125 |
| B01998P1 | 97 |
| B02265G1 | 63 |
| B02265G2 | 63 |
| B02265G3 | 63 |
| B02265G4 | 63 |
| B02597G4 | 63 |
| BAT-G1 | 124 |
| BMHSG-P | 35 |
| BMHSG-R | 35 |
| BMPP10-45P | 35 |
| BMPP10-45R | 35 |
| CHRG-G4 | 124 |
| E6336 | 115 |
| E6339 | 115 |
| E6349 | 115 |
| E6350 | 115 |
| E6351 | 115 |
| E6352 | 115 |
| E6353 | 115 |
| E6361 | 115 |
| E6362 | 115 |
| E6380G1 | 108 |
| E6381G1 | 108 |
| E6382G1 | 108 |
| E6383G1 | 108 |
| E6385G1 | 108 |
| E6390G1 | 108 |
| E6392G1 | 108 |
| H1120P42 | 105 |
| H1120P43 | 87 |
| H1120P55 | 76, 82 |
| H1216P7 | 53, 89 |
| H1216P8 | 42, 79, 85, 125 |
| H1216P9 | 97 |
| H1507P38 | 39 |
| H1835P11 | 63 |

| PART NUMBER | PAGE NUMBER |
|--------------|---------------|
| H1835P3 | 107, 113, 121 |
| P5916-BK | 41 |
| P5916G4-BK | 41 |
| P5916G5-BK | 41 |
| P5916G7-BK | 41 |
| P6810G1 | 84 |
| P6810G1-BK | 84 |
| P6810G3 | 84 |
| P6810G3-BK | 84 |
| P906 | 96 |
| P906-BK | 96 |
| P913 | 96 |
| P913-BK | 96 |
| P940 | 88 |
| P940-BK | 88 |
| P949 | 88 |
| P949-BK | 88 |
| P992 | 78 |
| P992-BK | 78 |
| P992G1 | 78 |
| P992G1-BK | 78 |
| P992G2 | 78 |
| P992G2-BK | 78 |
| PC5930S | 42, 79 |
| PC5930S-BK | 42, 79 |
| PC5930T | 42, 79 |
| PC5930T-BK | 42, 79 |
| PC5933S | 43, 79 |
| PC5933S-BK | 43, 79 |
| PC5933T | 43, 79 |
| PC5933T-BK | 43, 79 |
| PC5934S | 43, 79 |
| PC5934S-BK | 43, 79 |
| PC5934T | 43, 79 |
| PC5934T-BK | 43, 79 |
| PC-HSG-PP | 47 |
| PC-HSG-PP-BK | 47 |
| PC-HSG-SB | 83 |
| PC-HSG-SB-BK | 83 |
| PCSTAPLE-2 | 47 |
| PM1000G1 | 4, 6, 77, 123 |
| PM1002G1 | 77, 123, 128 |
| PM1003G1 | 77, 123, 128 |

| PART NUMBER | PAGE NUMBER |
|-----------------|------------------------|
| PM1003GX | 77, 123, 128 |
| PM16P12A30 | 69, 106, 112, 119, 126 |
| PM16P12A30-50 | 119, 126 |
| PM16P12C30 | 69, 106, 112, 119, 126 |
| PM16P12C30-50 | 119, 126 |
| PM16P12S30 | 69, 106, 112, 119, 126 |
| PM16P12S30-50 | 69, 106, 112, 119, 126 |
| PM16P1416A30 | 69, 106, 112, 119, 126 |
| PM16P1416A30-50 | 119, 126 |
| PM16P1416C30 | 69, 106, 112, 119, 126 |
| PM16P1416C30-50 | 119, 126 |
| PM16P1416S30 | 69, 106, 112, 119, 126 |
| PM16P1416S30-50 | 69, 106, 112, 119, 126 |
| PM16P1620A30 | 69, 106, 112, 119, 126 |
| PM16P1620A30-50 | 119, 126 |
| PM16P1620C30 | 69, 106, 112, 119, 126 |
| PM16P1620C30-50 | 119, 126 |
| PM16P1620S30 | 69, 106, 112, 119, 126 |
| PM16P1620S30-50 | 69, 106, 112, 119, 126 |
| PM16P2024A30 | 69, 106, 112, 119, 126 |
| PM16P2024A30-50 | 119, 126 |
| PM16P2024C30 | 69, 106, 112, 119, 126 |
| PM16P2024C30-50 | 119, 126 |
| PM16P2024S30 | 69, 106, 112, 119, 126 |
| PM16P2024S30-50 | 69, 106, 112, 119, 126 |
| PM16S12S32 | 69, 106, 112, 119, 126 |
| PM16S12S32-50 | 69, 106, 112, 119, 126 |
| PM16S1416S32 | 69, 106, 112, 119, 126 |
| PM16S1416S32-50 | 69, 106, 112, 119, 126 |
| PM16S1620S32 | 69, 106, 112, 119, 126 |
| PM16S1620S32-50 | 69, 106, 112, 119, 126 |
| PM16S2024S32 | 69, 106, 112, 119, 126 |
| PM16S2024S32-50 | 69, 106, 112, 119, 126 |
| PSBS50BLK | 67 |
| PSBS50BLK-BK | 67 |
| PSBS50BLU | 67 |
| PSBS50BLU-BK | 67 |
| PSBS50BRN | 67 |
| PSBS50BRN-BK | 67 |
| PSBS50GRA | 67 |
| PSBS50GRA-BK | 67 |
| PSBS50GRN | 67 |
| PSBS50GRN-BK | 67 |
| PSBS50-HDL-RED | 76 |

| PART NUMBER | PAGE NUMBER |
|----------------|-------------|
| PSBS50RED-BK | 67 |
| PSBS75XBLK | 68 |
| PSBS75XBLK-BK | 68 |
| PSBS75XCLP1 | 77 |
| PSBS75XCLP1-BK | 77 |
| PSBS75XCLP2 | 77 |
| PSBS75XCLP2-BK | 77 |
| PSBS75XGRN-BK | 68 |
| SB120-HDL-RED | 87 |
| SB175-LOCKOUT | 94 |
| SB350-LOCKOUT | 99 |
| SB50-HDL-RED | 82 |
| SBE80CLPRED | 105 |
| SBE80GRA | 102 |
| SBE80GRA-BK | 102 |
| SBE80HDLRED | 105 |
| SBE80ORN | 102 |
| SBE80ORN-BK | 102 |
| SBE80RED | 102 |
| SBE80RED-BK | 102 |
| SBE80YEL | 102 |
| SBE80YEL-BK | 102 |
| SBO60CLPRED | 105 |
| SBO60HDLRED | 105 |
| SBO60ORN | 102 |
| SBO60ORN-BK | 102 |
| SBO60RED | 102 |
| SBO60RED-BK | 102 |
| SBO60WHT | 102 |
| SBO60WHT-BK | 102 |
| SBO60YEL | 102 |
| SBO60YEL-BK | 102 |
| SBS50BLK | 67 |
| SBS50BLK-BK | 67 |
| SBS50BLU | 67 |
| SBS50BLU-BK | 67 |
| SBS50BRN | 67 |
| SBS50BRN-BK | 67 |
| SBS50GRA | 67 |
| SBS50GRA-BK | 67 |
| SBS50-HDL-RED | 76 |
| SBS50RED | 67 |
| SBS50RED-BK | 67 |

| PART NUMBER | PAGE NUMBER |
|-----------------|--------------------|
| SBS50WHT | 67 |
| SBS50WHT-BK | 67 |
| SBS75GBLK | 68 |
| SBS75GBLK-BK | 68 |
| SBS75GBLU | 68 |
| SBS75GBLU-BK | 68 |
| SBS75GBRN | 68 |
| SBS75GBRN-BK | 68 |
| SBS75GHDLRED | 76 |
| SBS75GPRBLK-BK | 68 |
| SBS75GWHT | 68 |
| SBS75GWHT-BK | 68 |
| SBS75XBLK | 68 |
| SBS75XBLK-BK | 68 |
| SBS75XBRN | 68 |
| SBS75XBRN-BK | 68 |
| SBS75XPRBLK-BK | 68 |
| SBS75XPRSBLK-BK | 68 |
| TA0001 | 7 |
| TA0002 | 5, 7 |
| TA0003 | 7 |
| TD0101 | 7, 57, 64 |
| TD0102 | 7, 57 |
| TD0104 | 5, 128 |
| TE0101 | 5, 7, 57, 64 |
| TE0102 | 5, 7, 57, 64 |
| TL0001 | 77, 123, 128 |
| TL0002 | 77, 123, 128 |
| TL0005 | 123 |
| TM0001 | 4, 7, 77, 123, 128 |
| TP0001 | 4, 7, 77, 123, 128 |
| VEH-G2 | 124 |

Additional Anderson™ Connectors



SPEC Pak®

- Sealed Power for Environmental Connections



Saf-D-Grid®

- DC Power Connection Solutions



Euro Battery Connector (EBC)

- DIN 43589-1 Standard
- Design / Materials meets EN1175-1



PowerMod®

- Mate First/Break Last and Mate Last/Break First Circuits



Power Drawer®

- Mixed Power and Signal Drawer Connectors



MARC

- Multi Axial Rotational Connector

For more information on these products, visit our products pages found at <https://www.andersonpower.com/us/en/ProductPages.html>

Your Best Connection™

HEADQUARTERS

Anderson Power Products®
13 Pratts Junction Road
Sterling, MA 01564-2305 USA
T: +(1) 978-422-3600
F: +(1) 978-422-0128

EUROPE

Anderson Power Products® Ltd.
Unit 3 Europa Court
Europa Boulevard
Westbrook, Warrington
Cheshire, WA5 7TN United Kingdom
T: +44 (0) 1925 428390
F: +44 (0) 1925 520203

ASIA / PACIFIC

IDEAL Anderson Asia Pacific Ltd.
Unit 922-928, Topsail Plaza
11 On Sum Street
Shatin N.T., Hong Kong
T: +(852) 2636 0836
F: +(852) 2635 9036

CHINA

IDEAL Anderson Technologies (Shenzhen) Ltd.
Block A8, Tantou Western Industrial Park
Songgang, Baoan District
Shenzhen, P.R. China 518105
T: +(86) 755 2768 2118/3393 2388
F: +(86) 755 2768 2218

TAIWAN

IDEAL Anderson Asia Pacific Ltd.
Taiwan Branch, 4F-2, No.116
Dadun 20th St., Situn District
Taichung City 407, Taiwan (R.O.C.)
T: +(886) 4 2310 6451
F: +(886) 4 2310 6460

INDIA

IDEAL INDUSTRIES India Private Limited
229-230, SPAZEDGE, Tower B
Sector 47, Sohna Road, Gurgaon – 122001
Haryana, India
T: +(91) 956 007 5905
www.ideal-Industries.in

All Data Subject To Change 2020-0055 CAT-PPMP REV 7

Anderson™ will use reasonable efforts to include accurate and up-to-date content in the catalog. All product information contained in the catalog including ordering information, illustrations, specifications, and dimensions, are believed to be reliable as of the date of publishing, but is subject to change without notice. Anderson™ makes no warranty or representation as to its accuracy. Content in the catalog may contain technical inaccuracies, typographical errors and may be changed or updated without notice. Anderson™ may also make improvements and/or changes to the products and/or to the programs described in the content at any time without notice. Current sales drawings and specifications are available upon request.

© 2020 Anderson Power Products, Inc. All rights reserved. APP®, A®, Anderson Power Products®, SB®, SBE®, SBO®, SBS®, SBX®, Power Clip®, Power Drawer®, PowerMod®, Saf-D-Grid®, SPEC Pak®, Powerpole® and the APP Logo are registered trademarks of Anderson Power Products, Inc. Anderson™ and Your Best Connection™ are trademarks of Anderson Power Products, Inc.



VISIT US AT WWW.ANDERSONPOWER.COM